

SLIM LED ARMATÜR

SLIM LED ARMATURE

Teknik Özellikler

Technical Specifications

Gövde : Alüminyum
Body : Aluminium

Gövde Renkleri : Beyaz
Body Colors : White

Difüzör : PMMA
Diffuser : PMMA

Renksel Geri Verim : 80
Color Rendering Index : 80

IP Derecesi : IP20
IP Rating : IP20

IK Derecesi : IK03
IK Rating : IK03

Elektriksel Koruma : Sınıf II
Electrical Protection : Class II

Çalışma Sıcaklığı : -20°C / 45°C
Operating Temp. Range : -20°C / 45°C



SLİM LED ARMATÜR

Kurulumu kolay, maksimum performansa sahip uzun ömürlü, ekonomik ve güvenilir bir siva altı tavan armatürüdür. Tüm iç mekanlarda; evlerde, ofislerde, hastane, otel, avm, mağazalar için idealdir.

SLIM LED ARMATURE

It is an easy to install, long-lasting, economical and reliable flush-mounted ceiling luminaire with maximum performance. In all interiors; Ideal for homes, offices, hospitals, hotels, shopping malls, stores.



YUVARLAK SLİM LED ARMATÜR ROUND SLİM LED ARMATURE

Enerji Verimliliği Sınıfı Energy Efficiency Class	Ürün Kodu Product Code	Güç (W) Power	Renk Sıcaklığı (K) Color Temperature	Işık Akısı (Lm) Luminous Flux	Boyutlar (ØxH) mm Dimensions	Kesme Ebatı (Ø) mm Cutting Size	Koli Adeti Quantity in Carton	Fiyat Price
A+G	BL-S1-2001	3W	3000 K	165	82 × 14	73	48	\$3,7
A+G	BL-S1-2002	3W	4000 K	165	82 × 14	73	48	\$3,7
A+G	BL-S1-2003	3W	6500 K	165	82 × 14	73	48	\$3,7
A+G	BL-S1-2004	6W	3000 K	390	118 × 14	110	48	\$5,0
A+G	BL-S1-2005	6W	4000 K	390	118 × 14	110	48	\$5,0
A+G	BL-S1-2006	6W	6500 K	390	118 × 14	110	48	\$5,0
A+G	BL-S1-2007	9W	3000 K	630	145 × 14	135	24	\$6,8
A+G	BL-S1-2008	9W	4000 K	630	145 × 14	135	24	\$6,8
A+G	BL-S1-2009	9W	6500 K	630	145 × 14	135	24	\$6,8
A+G	BL-S1-2010	12W	3000 K	960	168 × 14	155	24	\$7,6
A+G	BL-S1-2011	12W	4000 K	960	168 × 14	155	24	\$7,6
A+G	BL-S1-2012	12W	6500 K	960	168 × 14	155	24	\$7,6
A+G	BL-S1-2013	15W	3000 K	1200	190 × 14	175	24	\$8,1
A+G	BL-S1-2014	15W	4000 K	1200	190 × 14	175	24	\$8,1
A+G	BL-S1-2015	15W	6500 K	1200	190 × 14	175	24	\$8,1
A+G	BL-S1-2016	18W	3000 K	1440	225 × 15	210	24	\$9,2
A+G	BL-S1-2017	18W	4000 K	1440	225 × 15	210	24	\$9,2
A+G	BL-S1-2018	18W	6500 K	1440	225 × 15	210	24	\$9,2
A+G	BL-S1-2019	24W	3000 K	2040	300 × 15	285	24	\$16,1
A+G	BL-S1-2020	24W	4000 K	2040	300 × 15	285	24	\$16,1
A+G	BL-S1-2021	24W	6500 K	2040	300 × 15	285	24	\$16,1

KARE SLİM LED ARMATÜR SQUARE SLİM LED ARMATURE

Enerji Verimliliği Sınıfı Energy Efficiency Class	Ürün Kodu Product Code	Güç (W) Power	Renk Sıcaklığı (K) Color Temperature	Işık Akısı (Lm) Luminous Flux	Boyutlar (WxLxH) mm Dimensions	Kesme Ebatı (mm) Cutting Size	Koli Adeti Quantity in Carton	Fiyat Price
A+G	BL-S1-2022	18W	3000 K	1350	225 × 225 × 15	210 × 210	24	\$11,1
A+G	BL-S1-2023	18W	4000 K	1350	225 × 225 × 15	210 × 210	24	\$11,1
A+G	BL-S1-2024	18W	6500 K	1350	225 × 225 × 15	210 × 210	24	\$11,1
A+G	BL-S1-2025	24W	3000 K	1920	300 × 300 × 15	280 × 280	24	\$18,2
A+G	BL-S1-2026	24W	4000 K	1920	300 × 300 × 15	280 × 280	24	\$18,2
A+G	BL-S1-2027	24W	6500 K	1920	300 × 300 × 15	280 × 280	24	\$18,2

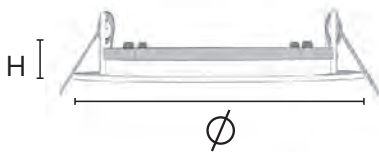

SIVA ÜSTÜ LED PANEL ARMATÜR

SURFACE MOUNTED LED PANEL

Teknik Özellikler

Technical Specifications

Gövde : Alüminyum
Body : Aluminium

Gövde Renkleri : Beyaz
Body Colors : White

Çerçeve : DKP Sac
Frame : DKP Metal Sheet

Difüzör : PMMA
Diffuser : PMMA

Renksel Geri Verim : 80
Color Rendering Index : 80

IP Derecesi : IP20
IP Rating : IP20

IK Derecesi : IK03
IK Rating : IK03

Elektriksel Koruma : Sınıf II
Electrical Protection : Class II

Çalışma Sıcaklığı : -20°C / 45°C
Operating Temp. Range : -20°C / 45°C



LED

3
YIL
GARANTİ

50.000
SAAT

SIVA ÜSTÜ LED PANEL ARMATÜR

Önemli ölçüde enerji ve bakım tasarrufu sağlayan yüksek performanslı düz panel armatürdür.

Şık minimalist tasarıma sahip ince led panellerimiz, azaltılmış enerji tüketimi ile geleneksel floresan tipi aydınlatma çözümlerine eşdeğerdir. Uygun maliyetli, ince bir aydınlatma hattı gerektiren ofis, sağlık, eğitim, otel, restoran, alışveriş merkezi ve ticari alanlar gibi geniş bir uygulama yelpazesi için uygundur.

SURFACE MOUNTED LED PANEL

It is a high-performance flat panel luminaire that provides significant energy and maintenance savings. Our slim led panels with stylish minimalist design are equivalent to traditional fluorescent type lighting solutions with reduced energy consumption. It is suitable for a wide range of applications such as office, health, education, hotel, restaurant, shopping mall and commercial areas that require a cost-effective, thin line of lighting.



SIVA ÜSTÜ YUVARLAK LED PANEL

SURFACE MOUNTED ROUND LED PANEL

Enerji Verimliliği Sınıfı Energy Efficiency Class	Ürün Kodu Product Code	Güç (W) Power	Renk Sıcaklığı (K) Color Temperature	Işık Akısı (Lm) Luminous Flux	Boyutlar (ØxH) mm Dimensions	Koli Adeti Quantity in Carton	Fiyat Price
	BL-S2-2013	15W	3000 K	1200	162 × 25	20	\$7,6
	BL-S2-2014	15W	4000 K	1200	162 × 25	20	\$7,6
	BL-S2-2015	15W	6500 K	1200	162 × 25	20	\$7,6
	BL-S2-2016	18W	3000 K	1440	210 × 25	20	\$10,5
	BL-S2-2017	18W	4000 K	1440	210 × 25	20	\$10,5
	BL-S2-2018	18W	6500 K	1440	210 × 25	20	\$10,5
	BL-S2-2019	24W	3000 K	2040	285 × 25	20	\$14,5
	BL-S2-2020	24W	4000 K	2040	285 × 25	20	\$14,5
	BL-S2-2021	24W	6500 K	2040	285 × 25	20	\$14,5

SIVA ÜSTÜ KARE LED PANEL

SURFACE MOUNTED SQUARE LED PANEL

Enerji Verimliliği Sınıfı Energy Efficiency Class	Ürün Kodu Product Code	Güç (W) Power	Renk Sıcaklığı (K) Color Temperature	Işık Akısı (Lm) Luminous Flux	Boyutlar (WxLxH) mm Dimensions	Koli Adeti Quantity in Carton	Fiyat Price
	BL-S2-2022	15W	3000 K	1200	162 × 162 × 25	20	\$8,4
	BL-S2-2023	15W	4000 K	1200	162 × 162 × 25	20	\$8,4
	BL-S2-2024	15W	6500 K	1200	162 × 162 × 25	20	\$8,4
	BL-S2-2025	18W	3000 K	1440	210 × 210 × 25	20	\$11,2
	BL-S2-2026	18W	4000 K	1440	210 × 210 × 25	20	\$11,2
	BL-S2-2027	18W	6500 K	1440	210 × 210 × 25	20	\$11,2
	BL-S2-2028	24W	3000 K	2040	285 × 285 × 25	20	\$15,6
	BL-S2-2029	24W	4000 K	2040	285 × 285 × 25	20	\$15,6
	BL-S2-2030	24W	6500 K	2040	285 × 285 × 25	20	\$15,6

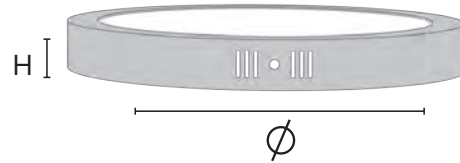
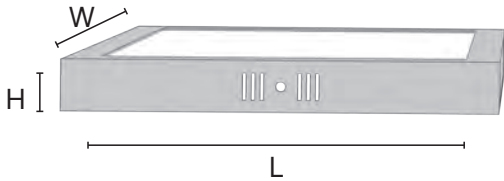

BACKLIGHT DOWNLIGHT ARMATÜR

BACKLIGHT DOWNLIGHT ARMATURE

Teknik Özellikler

Technical Specifications

Gövde : Alüminyum
Body : Aluminium

Gövde Renkleri : Beyaz
Body Colors : White

Difüzör : PMMA
Diffuser : PMMA

Renksel Geri Verim : 80
Color Rendering Index : 80

IP Derecesi : IP40
IP Rating : IP40

IK Derecesi : IK03
IK Rating : IK03

Elektriksel Koruma : Sınıf II
Electrical Protection : Class II

Çalışma Sıcaklığı : -20°C / 45°C
Operating Temp. Range : -20°C / 45°C



LED

3
YIL
GARANTİ

50.000
SAAT

IP40

BACKLIGHT DOWNLIGHT ARMATÜR

Özel alüminyum alaşımlı kasası mükemmel ısı dağılımı sağlar. Yeni nesil devre tasarımı akım sürücüsü ile yüksek ışık gücüne, verimli enerji tasarrufu ve maksimum performansa sahip bir sıva altı tavan armatürüdür. Kolay kurulum, uzun ömürlü, ekonomik ve güvenilir bir kullanım sunar.

Tüm iç mekanlarda; evlerde, ofislerde, hastane, otel, avm, mağaza ve özellikle vitrinler için idealdir.

BACKLIGHT DOWNLIGHT ARMATURE

Its special Aluminium alloy casing provides excellent heat dissipation. It is a flush-mounted ceiling luminaire with high light power, efficient energy saving and maximum performance with its new generation circuit design current driver. It offers easy installation, long-lasting, economical and reliable use.

In all interiors; It is ideal for homes, offices, hospitals, hotels, shopping malls, stores and especially showcases.



YUVARLAK BACKLIGHT DOWNLIGHT ARMATÜR ROUND BACKLIGHT DOWNLIGHT ARMATURE

Enerji Verimliliği Sınıfı Energy Efficiency Class	Ürün Kodu Product Code	Güç (W) Power	Renk Sıcaklığı (K) Color Temperature	Işık Akısı (Lm) Luminous Flux	Boyutlar (ØxH) mm Dimensions	Kesme Ebatı (Ø) mm Cutting Size	Koli Adeti Quantity in Carton	Fiyat Price
A T G E	BL-BD-0001	10W	3000 K	1110	94 × 42	73	50	\$42,7
A T G E	BL-BD-0002	10W	4000 K	1110	94 × 42	73	50	\$42,7
A T G E	BL-BD-0003	10W	6500 K	1110	94 × 42	73	50	\$42,7
A T G F	BL-BD-0004	15W	3000 K	1575	127 × 46	97	50	\$45,2
A T G F	BL-BD-0005	15W	4000 K	1575	127 × 46	97	50	\$45,2
A T G F	BL-BD-0006	15W	6500 K	1575	127 × 46	97	50	\$45,2
A T G E	BL-BD-0007	20W	3000 K	2220	164 × 58	140	50	\$51,3
A T G E	BL-BD-0008	20W	4000 K	2220	164 × 58	140	50	\$51,3
A T G E	BL-BD-0009	20W	6500 K	2220	164 × 58	140	50	\$51,3
A T G E	BL-BD-0010	30W	3000 K	3330	222 × 54,5	177	50	\$81,4
A T G E	BL-BD-0011	30W	4000 K	3330	222 × 54,5	177	50	\$81,4
A T G E	BL-BD-0012	30W	6500 K	3330	222 × 54,5	177	50	\$81,4

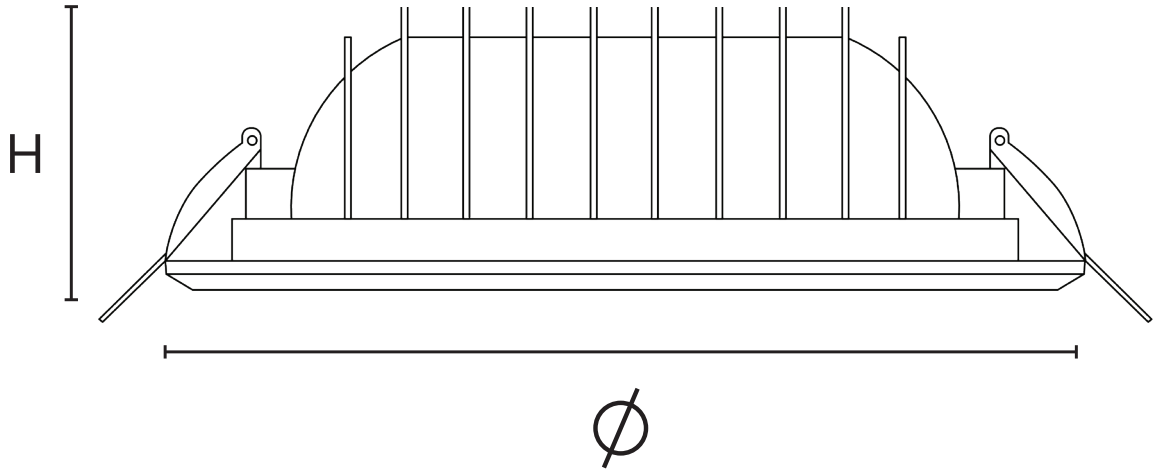

BETA BACKLIGHT DOWNLIGHT

BETA BACKLIGHT DOWNLIGHT

Teknik Özellikler Technical Specifications

Gövde : Alüminyum
Body : Aluminium

Gövde Renkleri : Beyaz
Body Colors : White

Difüzör : PMMA
Diffuser : PMMA

Renksel Geri Verim : 80
Color Rendering Index : 80

IP Derecesi : IP40
IP Rating : IP40

IK Derecesi : IK03
IK Rating : IK03

Elektriksel Koruma : Sınıf II
Electrical Protection : Class II

Çalışma Sıcaklığı : -20°C / 45°C
Operating Temp. Range : -20°C / 45°C



LED

3
YIL
GARANTİ

50.000
SAAT



BETA BACKLIGHT DOWNLIGHT

Özel alüminyum alaşımlı kasası mükemmel ısı dağılımı sağlar. Yeni nesil devre tasarımı akım sürücüsü ile yüksek ışık gücüne, verimli enerji tasarrufu ve maksimum performansa sahip bir sıva altı tavan armatürüdür. Kolay kurulum, uzun ömürlü, ekonomik ve güvenilir bir kullanım sunar.

Tüm iç mekanlarda; evlerde, ofislerde, hastane, otel, avm, mağaza ve özellikle vitrinler için idealdir.

BETA BACKLIGHT DOWNLIGHT

Its special Aluminium alloy casing provides excellent heat dissipation. It is a flush-mounted ceiling luminaire with high light power, efficient energy saving and maximum performance with its new generation circuit design current driver. It offers easy installation, long-lasting, economical and reliable use.

In all interiors; It is ideal for homes, offices, hospitals, hotels, shopping malls, stores and especially showcases.



BETA BACKLIGHT DOWNLIGHT ARMATÜR

BETA BACKLIGHT DOWNLIGHT ARMATURE

Enerji Verimliliği Sınıfı Energy Efficiency Class	Ürün Kodu Product Code	Güç (W) Power	Renk Sıcaklığı (K) Color Temperature	Işık Akısı (Lm) Luminous Flux	Boyutlar (ØxH) mm Dimensions	Kesme Ebatı (Ø) mm Cutting Size	Koli Adeti Quantity in Carton	Fiyat Price
A++ F	BL-BD-2001	8W	3000 K	800	97 × 55	85	36	\$41,90
A++ F	BL-BD-2002	8W	4000 K	800	97 × 55	85	36	\$41,90
A++ F	BL-BD-2003	8W	6500 K	800	97 × 55	85	36	\$41,90
A++ F	BL-BD-2004	10W	3000 K	1000	117 × 48	105	36	\$45,60
A++ F	BL-BD-2005	10W	4000 K	1000	117 × 48	105	36	\$45,60
A++ F	BL-BD-2006	10W	6500 K	1000	117 × 48	105	36	\$45,60
A++ F	BL-BD-2007	15W	3000 K	1500	147 × 54	130	36	\$65,30
A++ F	BL-BD-2008	15W	4000 K	1500	147 × 54	130	36	\$65,30
A++ F	BL-BD-2009	15W	6500 K	1500	147 × 54	130	36	\$65,30
A++ F	BL-BD-2010	18W	3000 K	1800	175 × 58	160	18	\$62,50
A++ F	BL-BD-2011	18W	4000 K	1800	175 × 58	160	18	\$62,50
A++ F	BL-BD-2012	18W	6500 K	1800	175 × 58	160	18	\$62,50
A++ F	BL-BD-2013	25W	3000 K	2500	192 × 55	175	16	\$75,50
A++ F	BL-BD-2014	25W	4000 K	2500	192 × 55	175	16	\$75,50
A++ F	BL-BD-2015	25W	6500 K	2500	192 × 55	175	16	\$75,50
A++ F	BL-BD-2016	30W	3000 K	3000	227 × 58	210	16	\$81,70
A++ F	BL-BD-2017	30W	4000 K	3000	227 × 58	210	16	\$81,70
A++ F	BL-BD-2018	30W	6500 K	3000	227 × 58	210	16	\$81,70

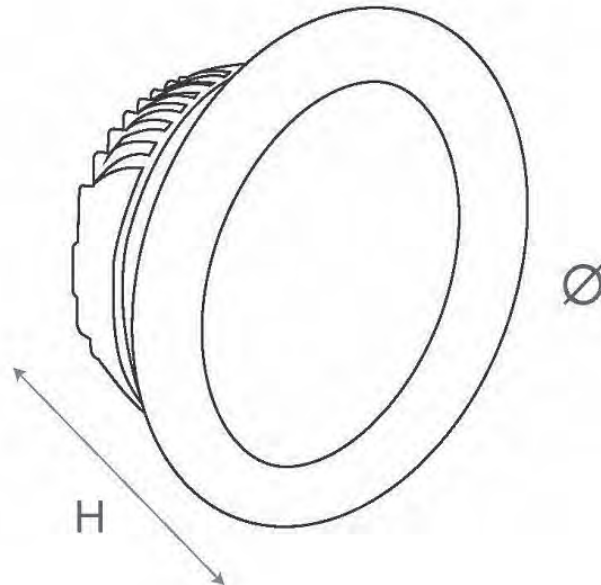

COB LED ARMATÜR

COB LED ARMATURE

Teknik Özellikler

Technical Specifications

Gövde : Alüminyum
Body : Aluminium

IP Derecesi : IP20
IP Rating : IP20

Güç Faktörü : 0.9
Power Factor : 0.9

Renksel Geri Verim : 80
Color Rendering Index : 80



LED

3
YIL
GARANTİ

50.000
SAAT



COB LED ARMATÜR

Yüksek kalitede Led çipine sahiptir. Renk değişimlerine ve sararmaya dayanıklı, alüminyum enjeksiyonlu, elektrostatik toz boyalı ve uzun ömürlü homojen ışık veren optik ekranlı bir aydınlatma armatürüdür.

Ayrıca 0-20° ayarlanabilir ışık yönü, bağlantı klipsleri ile lamba panelini ve elleri korur, montajı kolaydır.

Ürünümüzü ev, ofis, mağaza, müze, kafe vb. birçok yerde gönül rahatlığı ile tercih edebilirsiniz.

COB LED ARMATURE

It has a high-quality Led chip. It is a luminaire with an optical screen that is resistant to colour changes and yellowing, is an aluminium injection, electrostatic powder-coated and gives long-lasting homogeneous light.

In addition, 0-20° adjustable light direction, connection clips protect the lamp panel and hands. It's easy to install.

You can use our product in your home, office, shop, museum, cafe, etc. You can choose from many places with peace of mind.



COB LED ARMATÜR

COB LED ARMATURE

Enerji Verimliliği Sınıfı Energy Efficiency Class	Ürün Kodu Product Code	Güç (W) Power	Renk Sıcaklığı (K) Color Temperature	Işık Akısı (Lm) Luminous Flux	Boyutlar (ØxH) mm Dimensions	Kesme Ebatı (Ø) mm Cutting Size	Koli Adeti Quantity in Carton	Fiyat Price
A++ E	BL-COB1-0001	7W	3000 K	700	108 × 65	85	36	\$45,00
A++ E	BL-COB1-0002	7W	4000 K	700	108 × 65	85	36	\$45,00
A++ E	BL-COB1-0003	7W	6500 K	700	108 × 65	85	36	\$45,00
A++ E	BL-COB1-0004	9W	3000 K	900	128 × 55	105	36	\$46,40
A++ E	BL-COB1-0005	9W	4000 K	900	128 × 55	105	36	\$46,40
A++ E	BL-COB1-0006	9W	6500 K	900	128 × 55	105	36	\$46,40
A++ E	BL-COB1-0007	12W	3000 K	1250	150 × 55	130	36	\$59,30
A++ E	BL-COB1-0008	12W	4000 K	1250	150 × 55	130	36	\$59,30
A++ E	BL-COB1-0009	12W	6500 K	1250	150 × 55	130	36	\$59,30
A++ E	BL-COB1-0010	25W	3000 K	2500	200 × 55	180	16	\$73,00
A++ E	BL-COB1-0011	25W	4000 K	2500	200 × 55	180	16	\$73,00
A++ E	BL-COB1-0012	25W	6500 K	2500	200 × 55	180	16	\$73,00
A++ E	BL-COB1-0013	30W	3000 K	3000	240 × 58	210	16	\$80,50
A++ E	BL-COB1-0014	30W	4000 K	3000	240 × 58	210	16	\$80,50
A++ E	BL-COB1-0015	30W	6500 K	3000	240 × 58	210	16	\$80,50

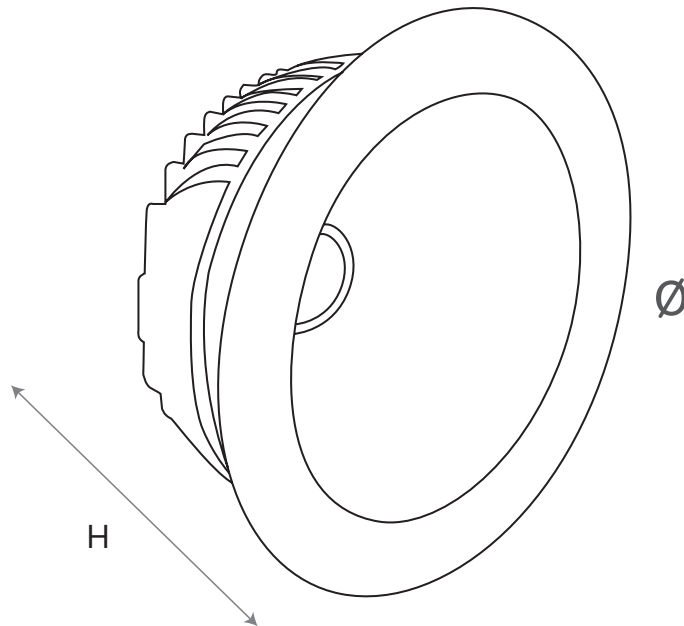

LED MOBİL SPOT

LED MOBILE SPOT

Teknik Özellikler

Technical Specifications

Gövde : Polikarbon
Body : Polycarbon

Sürücü: On-Board
Driver: DOB

Giriş Gerilimi : 100-265 V AC
Input Voltage: 100-265 V AC

Renksel Geri Verim : 80
Color Rendering Index : 80

IP Derecesi : IP20
IP Rating : IP20

Çalışma Sıcaklığı : -25°C / 40°C
Operating Temperature Range : -25°C / 40°C



LED



50.000
SAAT



LED MOBİL SPOT

Uzun ömürlü, dayanıklı, kullanımı kolay ve açısı ayarlanabilir gömme aydınlatma sunan spot optikler, her türlü iç mekanın duvar bölmeleri, raflar, dolaplar, çalışma ve sunum istasyonları, sergi standları vb. panellerin görünümünü güzelleştiren kompakt bir tasarıma sahiptir.

LED MOBILE SPOT

Offering long-lasting, durable, easy-to-use and adjustable angle recessed lighting, spot optics have a compact design that enhances the appearance of wall bays, shelves, cabinets, work and presentation stations, exhibition stands, etc. panels of all kinds of interiors.



LED MOBİL SPOT

LED MOBILE SPOT

Enerji Verimliliği Sınıfı Energy Efficiency Class	Ürün Kodu Product Code	Güç (W) Power	Renk Sıcaklığı (K) Color Temperature	Işık Akısı (Lm) Luminous Flux	Boyutlar (ØxH) mm Dimensions	Kesme Ebatı (Ø) mm Cutting Size	Renk Color	Koli Adeti Quantity in Carton	Fiyat Price
	BL-MB-0001	5W	3000 K	400	90 X 38	75	Beyaz White	36	\$6,2
	BL-MB-0002	5W	4000 K	400	90 X 38	75	Beyaz White	36	\$6,2
	BL-MB-0003	5W	6500 K	400	90 X 38	75	Beyaz White	36	\$6,2
	BL-MB-1001	5W	3000 K	400	90 X 38	75	Siyah Black	36	\$6,2
	BL-MB-1002	5W	4000 K	400	90 X 38	75	Siyah Black	36	\$6,2
	BL-MB-1003	5W	6500 K	400	90 X 38	75	Siyah Black	36	\$6,2

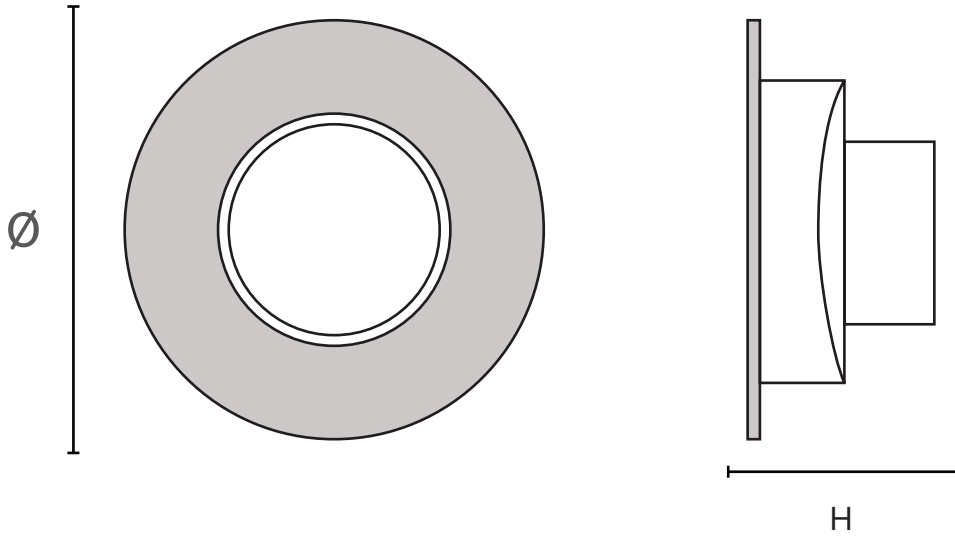

GU10 DUYLU SPOT

GU10 SPOT

Teknik Özellikler

Technical Specifications

Gövde : Alüminyum
Body : Aluminium

IP Derecesi : IP20
IP Rating : IP20

Montaj : Sıva Altı
Mounting : Flush Mounted

Kullanım : GU10 Led/Halojen Ampul
Usage : GU10 Led/Halogen Bulb



GU10 DUYLU SPOT (İKİLİ KASA)

GU10 SPOT (DOUBLE CASE)



GU10 DUYLU SPOT

Sıva altı kullanıma uygun, sağlam ve estetik alüminyum alaşım gövde. GU 10 duyu tip ampuller ile Enkandesan ampullerin yerine düşük enerji tüketimi, yüksek ışık çıkışı ve aydınlatma konforu sağlar.

Ürünümüzü ev, ofis, mağaza, müze, kafe vb. birçok yerde gönül rahatlığı ile tercih edebilirsiniz.

GU10 SPOT

Solid and aesthetic aluminium alloy body suitable for flush-mounted use. GU 10 socket type bulbs provide low energy consumption, high light output and lighting comfort instead of incandescent bulbs.

You can use our product in your home, office, shop, museum, cafe, etc. You can choose from many places with peace of mind.



GU10 DUYLU YUVARLAK SPOT

GU10 SPOT

Ürün Kodu Product Code	Giriş Voltajı Input Voltage	Duy Tipi Socket Type	Renk Color	Boyutlar (mm) Dimensions	Kesme Ebatı (Ø) mm Cutting Size	Koli Adeti Quantity in Carton	Fiyat Price
BL-GU-1001	220-230 V AC	GU-10	Siyah	100 × 30	85	100	\$9,3
BL-GU-1002	220-230 V AC	GU-10	Beyaz	100 × 30	85	100	\$9,3

GU10 DUYLU KARE SPOT

GU10 SPOT

Ürün Kodu Product Code	Giriş Voltajı Input Voltage	Duy Tipi Socket Type	Renk Color	Boyutlar (mm) Dimensions	Kesme Ebatı (Ø) mm Cutting Size	Koli Adeti Quantity in Carton	Fiyat Price
BL-GU-1003	220-230 V AC	GU-10	Siyah	100 × 100 × 30	85	100	\$10,4
BL-GU-1004	220-230 V AC	GU-10	Beyaz	100 × 100 × 30	85	100	\$10,4

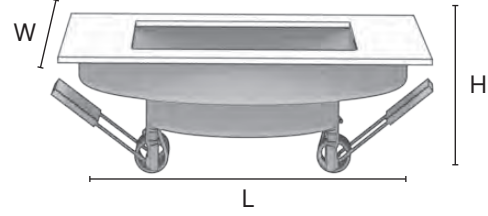
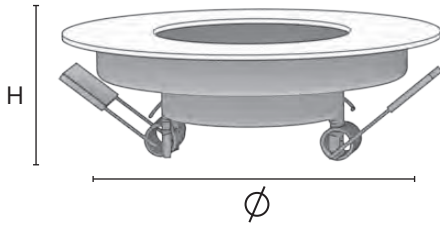

GU10 DUYLU YUVARLAK SPOT (İKİLİ KASA)

GU10 SPOT (DOUBLE CASE)

Ürün Kodu Product Code	Giriş Voltajı Input Voltage	Duy Tipi Socket Type	Renk Color	Boyutlar (WxL) Dimensions	Kesme Ebatı (mm) Cutting Size	Koli Adeti Quantity in Carton	Fiyat Price
BL-GU-2001	220-230 V AC	GU-10	Siyah	100 × 185	85 × 165	40	\$18,1
BL-GU-2002	220-230 V AC	GU-10	Beyaz	100 × 185	85 × 165	40	\$18,1

GU10 DUYLU KARE SPOT (İKİLİ KASA)

GU10 SPOT (DOUBLE CASE)

Ürün Kodu Product Code	Giriş Voltajı Input Voltage	Duy Tipi Socket Type	Renk Color	Boyutlar (WxL) Dimensions	Kesme Ebatı (mm) Cutting Size	Koli Adeti Quantity in Carton	Fiyat Price
BL-GU-2003	220-230 V AC	GU-10	Siyah	100 × 185	85 × 165	40	\$14,5
BL-GU-2004	220-230 V AC	GU-10	Beyaz	100 × 185	85 × 165	40	\$14,5

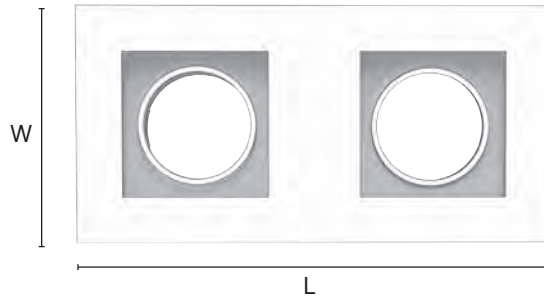
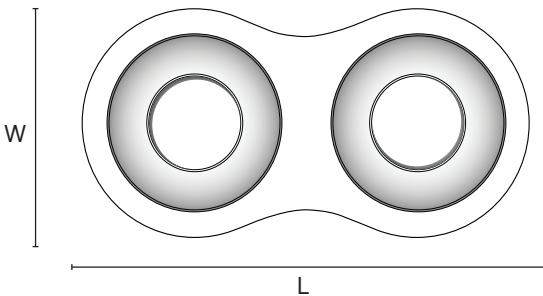

SIVA ÜSTÜ GU10 DUYLU ARMATÜR

SURFACE FITTING GU10 ARMATURE

Teknik Özellikler

Technical Specifications

Gövde : Alüminyum
Body : Aluminium

IP Derecesi : IP20
IP Rating : IP20

Montaj : Sıva Üstü
Mounting : Surface Mounted

Kullanım : GU10 Led Ampul
Usage : GU10 Led Bulb

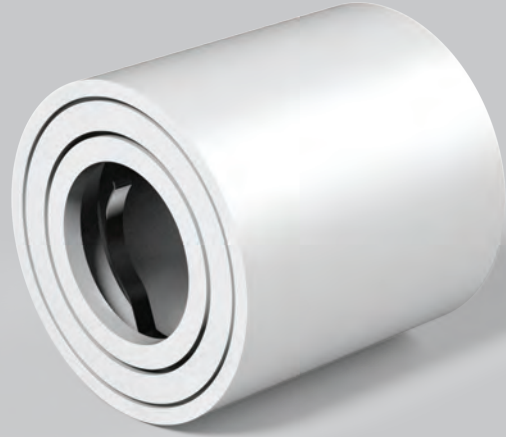
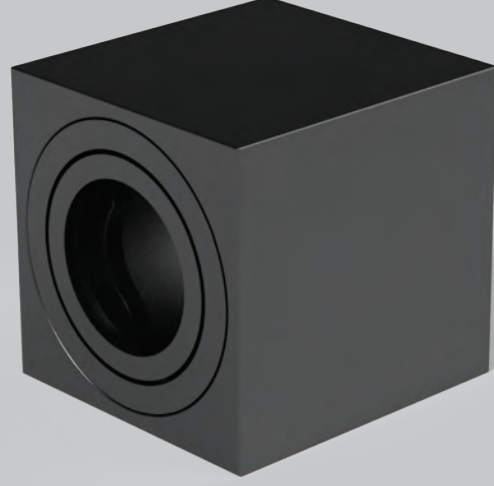

SIVA ÜSTÜ GU10 DUYLU ARMATÜR

Sıva üstü kullanıma uygun, sağlam ve estetik alüminyum alaşım gövde. GU 10 duy tipi ampuller ile Enkandesan ampullerin yerine düşük enerji tüketimi, yüksek ışık çıkışı ve aydınlatma konforu sağlar.

Ürünümüzü ev, ofis, mağaza, müze, kafe vb. birçok yerde gönül rahatlığı ile tercih edebilirsiniz.

SURFACE FITTING GU10 ARMATURE

Durable and aesthetic aluminium alloy body suitable for surface-mounted use. GU 10 socket type bulbs provide low energy consumption, high light output and lighting comfort instead of incandescent bulbs.

You can use our product in your home, office, shop, museum, cafe, etc. You can choose from many places with peace of mind.



KARE SIVA ÜSTÜ GU10 DUYLU ARMATÜR

SQUARE SURFACE FITTING GU10 ARMATURE

Ürün Kodu Product Code	Duy Tipi Socket Type	Boyutlar (WxL) mm Dimensions	Renk Color	Koli Adeti Quantity in Carton	Fiyat Price
BL-GU-1005	GU-10	80×80	Siyah	40	\$18,1
BL-GU-1006	GU-10	80×80	Beyaz	40	\$18,1

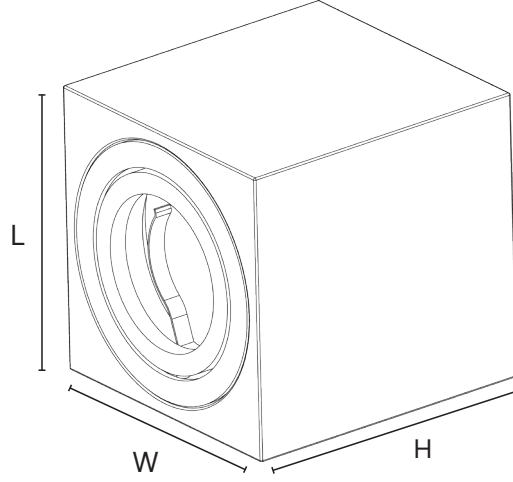

YUVARLAK SIVA ÜSTÜ GU10 DUYLU ARMATÜR

ROUND SURFACE FITTING GU10 ARMATURE

Ürün Kodu Product Code	Duy Tipi Socket Type	Dış Çap mm Outer Diameter	Renk Color	Koli Adeti Quantity in Carton	Fiyat Price
BL-GU-1007	GU-10	80	Siyah	40	\$14,5
BL-GU-1008	GU-10	80	Beyaz	40	\$14,5

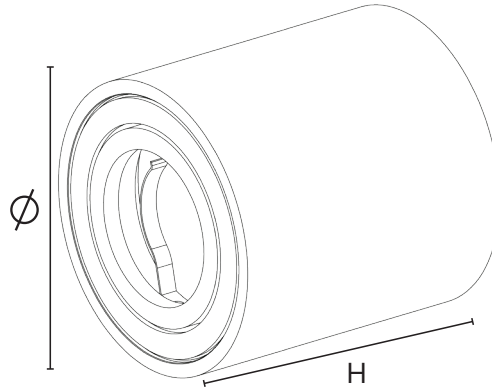

RAY SPOT GU10 DUYLU ARMATÜR

RAIL SPOT GU10 WITH SOCKET ARMATURE

Teknik Özellikler

Technical Specifications

Gövde : Alüminyum
Body : Aluminium

IP Derecesi : IP20
IP Rating : IP20

Montaj : Ray
Mounting : Rail

Kullanım : GU10 Led Ampul
Usage : GU10 Led Bulb



GU10 DUYLU RAY SPOT

GU10 Duylu Ray Spotlar; başta mağaza, müze, sahne, kafe, restoran, ofis vb. birçok yerde kullanılan aydınlatma armatürleridir. Tavana veya duvara monte edilmiş ray aparatı üzerinde hareket edebilir ve kendi ekseninde 360° yön değiştirerek vitrin, raf, stand ve reyon gibi belirli bölgeleri aydınlatarak dikkat çekerler.

GU 10 duy tipi ampuller ile Enkandesan ampullerin yerine düşük enerji tüketimi, yüksek ışık çıkışı ve aydınlatma konforu sağlar.

RAIL SPOT GU10 WITH SOCKET ARMATURE

GU10 With Socket Rail Spots; mainly for the shop, museum, stage, cafe, restaurant, office etc. They are lighting fixtures used in many places. They can move on the ceiling or wall-mounted rail apparatus and change direction 360° on their axis, attracting attention by illuminating certain areas such as showcases, shelves, stands and sections.

GU 10 socket type bulbs provide low energy consumption, high light output and lighting comfort instead of incandescent bulbs.



RAY SPOT GU10 DUYLU ARMATÜR

RAIL SPOT GU10 WITH SOCKET ARMATURE

Ürün Kodu Product Code	Giriş Voltajı Input Voltage	Duy Tipi Socket Type	Renk Color	İç Çap Ø (mm) Inner Diameter	Koli Adeti Quantity in Carton	Fiyat Price
BL-GU-1010	220-230 V AC	GU-10	Siyah	55	40	\$18,00
BL-GU-1011	220-230 V AC	GU-10	Beyaz	55	40	\$18,00

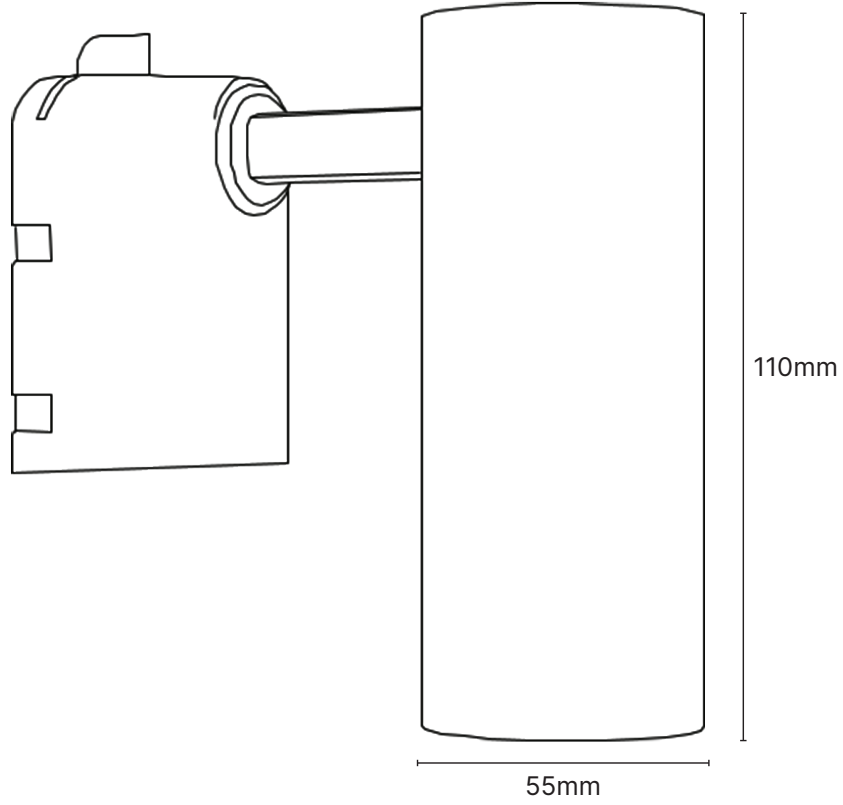

LED FRAMELESS DOWNLIGHT ARMATÜR

LED FRAMELESS DOWNLIGHT ARMATURE

Teknik Özellikler

Technical Specifications

Gövde : Alüminyum
Body : Aluminium

Gövde Renkleri : Beyaz
Body Colors : White

Difüzör : Polikarbonat (PC)
Diffuser : Polycarbonate

Renksel Geri Verim : 80
Color Rendering Index : 80

IP Derecesi : IP40
IP Rating : IP40

IK Derecesi : IK04
IK Rating : IK04

Elektriksel Koruma : Sınıf II
Electrical Protection : Class II

Çalışma Sıcaklığı : -20°C / 45°C
Operating Temp. Range : -20°C / 45°C



LED

3
YIL
GARANTİ

50.000
SAAT

LED FRAMELESS DOWNLIGHT ARMATÜR

2'si 1 arada çerçevesiz ince şık ve kullanışlı tasarım, alüminyum soğutucu taban, daha esnek ve kullanımı rahat klipsler ile hem yüzeye hem de gömme olarak monte edebilirsiniz.

LED FRAMELESS DOWNLIGHT ARMATURE

With 2 in 1 frameless slim, stylish and useful design, aluminium cooler base, more flexible and convenient to use clips, you can be mounted both on the surface and flush.



LED FRAMELESS DOWNLIGHT ARMATÜR

LED FRAMELESS DOWNLIGHT ARMATURE

Enerji Verimliliği Sınıfı Energy Efficiency Class	Ürün Kodu Product Code	Güç (W) Power	Renk Sıcaklığı (K) Color Temperature	Işık Akısı (Lm) Luminous Flux	Boyutlar (ØxH) mm Dimensions	Kesme Ebatı(mm) Cutting Size	Koli Adeti Quantity in Carton	Fiyat Price
A+ G F	BL-D1-0001	9W	3000 K	900	Ø90 × 20	55 - 80	36	\$10,0
A+ G F	BL-D1-0002	9W	4000 K	900	Ø90 × 20	55 - 80	36	\$10,0
A+ G F	BL-D1-0003	9W	6500 K	900	Ø90 × 20	55 - 80	36	\$10,0
A+ G F	BL-D1-0004	18W	3000 K	1800	Ø120 × 20	55 - 105	24	\$13,5
A+ G F	BL-D1-0005	18W	4000 K	1800	Ø120 × 20	55 - 105	24	\$13,5
A+ G F	BL-D1-0006	18W	6500 K	1800	Ø120 × 20	55 - 105	24	\$13,5
A+ G F	BL-D1-0007	24W	3000 K	2400	Ø175 × 20	55 - 160	16	\$19,1
A+ G F	BL-D1-0008	24W	4000 K	2400	Ø175 × 20	55 - 160	16	\$19,1
A+ G F	BL-D1-0009	24W	6500 K	2400	Ø175 × 20	55 - 160	16	\$19,1
A+ G F	BL-D1-0010	36W	3000 K	3600	Ø225 × 20	55 - 210	12	\$27,1
A+ G F	BL-D1-0011	36W	4000 K	3600	Ø225 × 20	55 - 210	12	\$27,1
A+ G F	BL-D1-0012	36W	6500 K	3600	Ø225 × 20	55 - 210	12	\$27,1

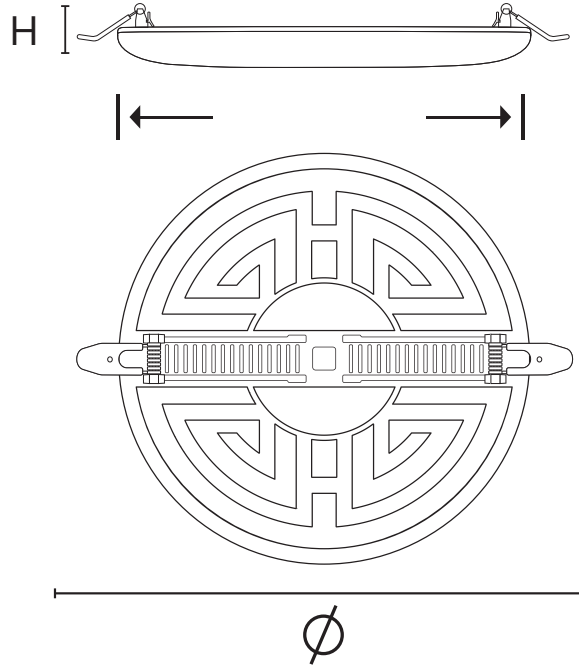

LED FRAMELESS SIVA ÜSTÜ DOWNLIGHT ARMATÜR

LED FRAMELESS SURFACE MOUNTED DOWNLIGHT ARMATURE

Teknik Özellikler

Technical Specifications

Gövde : Alüminyum
Body : Aluminium

Difüzör : Polikarbon
Diffuser : Polycarbonate

Giriş Gerilimi : 220-240 V AC
Input Voltage : 220-240 V AC

Renksel Geri Verim : 80
Color Rendering Index : 80

IP Derecesi : IP20
IP Rating : IP20

Elektriksel Koruma : Sınıf II
Electrical Protection : Class II

Çalışma Sıcaklığı : -20°C / 45°C
Operating Temp. Range : -20°C / 45°C



LED FRAMELESS SIVA ÜSTÜ DOWNLIGHT ARMATÜR
40W Çerçevesiz LED tavan armatürünüz, yüksek performans ve parlaklığına rağmen enerji tasarrufu sağlayan verimliliği ve göz dostu aydınlatması ile büyüü bir atmosfer yaratsın.

LED FRAMELESS SURFACE MOUNTED DOWNLIGHT ARMATURE
Let your 40W Frameless LED ceiling luminaire create a magical atmosphere with its energy-saving efficiency and eye-friendly lighting, despite its high performance and brightness.



LED FRAMELESS SIVA ÜSTÜ DOWNLIGHT ARMATÜR

LED FRAMELESS SURFACE MOUNTED DOWNLIGHT ARMATURE

Enerji Verimliliği Sınıfı Energy Efficiency Class	Ürün Kodu Product Code	Güç (W) Power	Renk Sıcaklığı (K) Color Temperature	Işık Akısı (Lm) Luminous Flux	Boyutlar (ØxH) mm Dimensions	Koli Adeti Quantity in Carton	Fiyat Price
	BL-D1-1001	40W	3000 K	4.350	220 X 40	20	\$34,8
	BL-D1-1002	40W	4000 K	4.350	220 X 40	20	\$34,8
	BL-D1-1003	40W	6500 K	4.350	220 X 40	20	\$34,8

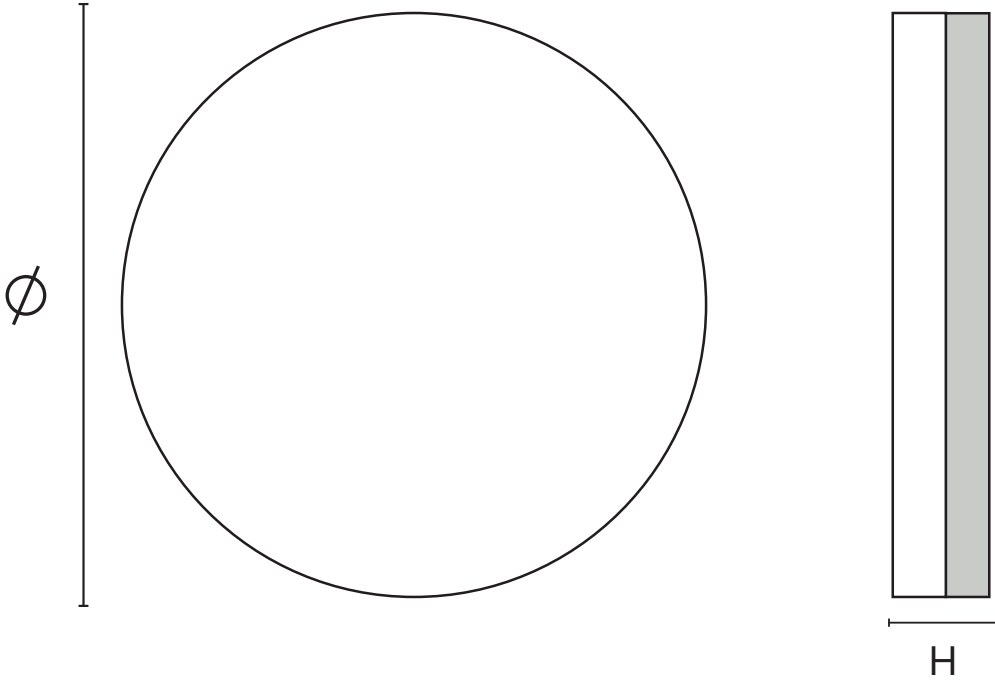

SLIM LED PANEL ARMATÜR

SLIM LED PANEL ARMATURE

Teknik Özellikler

Technical Specifications

Gövde : Alüminyum
Body : Aluminium

Gövde Renkleri : Beyaz
Body Colors : White

Difüzör : PMMA
Diffuser : PMMA

Renksel Geri Verim : 80
Color Rendering Index : 80

IK Derecesi : IK03
IK Rating : IK03

Elektriksel Koruma : Sınıf II
Electrical Protection : Class II

Çalışma Sıcaklığı : -20°C / 45°C
Operating Tem. Range : -20°C / 45°C



LED

3
YIL
GARANTİ

50.000
SAAT

SLIM LED PANEL ARMATÜR

Önemli ölçüde enerji ve bakım tasarrufu sağlayan yüksek performanslı düz panel armatürdür.

Şık minimalist tasarıma sahip ince led panellerimiz, azaltılmış enerji tüketimi ile geleneksel floresan tipi aydınlatma çözümlerine eşdeğerdir. Uygun maliyetli, ince bir aydınlatma hattı gerektiren ofis, sağlık, eğitim, otel, restoran, alışveriş merkezi ve ticari alanlar gibi geniş bir uygulama yelpazesi için uygundur.

SLIM LED PANEL ARMATURE



It is a high-performance flat panel luminaire that provides significant energy and maintenance savings.

Our slim led panels with stylish minimalist design are equivalent to traditional fluorescent type lighting solutions with reduced energy consumption. It is suitable for a wide range of applications such as office, health, education, hotel, restaurant, shopping mall and commercial areas that require a cost-effective, thin line of lighting.





60X60 SLIM LED PANEL ARMATÜR

60X60 SLIM LED PANEL ARMATURE

Enerji Verimliliği Sınıfı Energy Efficiency Class	Ürün Kodu Product Code	Güç (W) Power	Renk Sıcaklığı (K) Color Temperature	Işık Akısı (Lm) Luminous Flux	Boyutlar (WxLxH) mm Dimensions	Kesme Ebatı(mm) Cutting Size	Koli Adeti Quantity in Carton	Fiyat Price
	BL-O5-2001	40W	3000 K	3600	595 × 595 × 7.5	580 × 580	12	\$45,6
	BL-O5-2002	40W	4000 K	3600	595 × 595 × 7.5	580 × 580	12	\$45,6
	BL-O5-2003	40W	6500 K	3600	595 × 595 × 7.5	580 × 580	12	\$45,6



30X30 SLIM LED PANEL ARMATÜR

30X30 SLIM LED PANEL ARMATURE

Enerji Verimliliği Sınıfı Energy Efficiency Class	Ürün Kodu Product Code	Güç (W) Power	Renk Sıcaklığı (K) Color Temperature	Işık Akısı (Lm) Luminous Flux	Boyutlar (WxLxH) mm Dimensions	Kesme Ebatı(mm) Cutting Size	Koli Adeti Quantity in Carton	Fiyat Price
	BL-O8-0001	24W	3000 K	1600	295 × 295 × 7.5	270 × 270	12	\$27,9
	BL-O8-0002	24W	4000 K	1600	295 × 295 × 7.5	270 × 270	12	\$27,9
	BL-O8-0003	24W	6500 K	1600	295 × 295 × 7.5	270 × 270	12	\$27,9

30X60 SLIM LED PANEL ARMATÜR

30X60 SLIM LED PANEL ARMATURE

Enerji Verimliliği Sınıfı Energy Efficiency Class	Ürün Kodu Product Code	Güç (W) Power	Renk Sıcaklığı (K) Color Temperature	Işık Akısı (Lm) Luminous Flux	Boyutlar (WxLxH) mm Dimensions	Kesme Ebatı(mm) Cutting Size	Koli Adeti Quantity in Carton	Fiyat Price
	BL-O6-2001	24W	3000 K	1600	295 × 595 × 7.5	270 × 580	12	\$34,7
	BL-O6-2002	24W	4000 K	1600	295 × 595 × 7.5	270 × 580	12	\$34,7
	BL-O6-2003	24W	6500 K	1600	295 × 595 × 7.5	270 × 580	12	\$34,7

30X120 SLIM LED PANEL ARMATÜR

30X120 SLIM LED PANEL ARMATURE

Enerji Verimliliği Sınıfı Energy Efficiency Class	Ürün Kodu Product Code	Güç (W) Power	Renk Sıcaklığı (K) Color Temperature	Işık Akısı (Lm) Luminous Flux	Boyutlar (WxLxH) mm Dimensions	Kesme Ebatı(mm) Cutting Size	Koli Adeti Quantity in Carton	Fiyat Price
	BL-O7-2001	48W	3000 K	3200	295 × 1195 x 7.5	270 × 1180	12	\$68,9
	BL-O7-2002	48W	4000 K	3200	295 × 1195 x 7.5	270 × 1180	12	\$68,9
	BL-O7-2003	48W	6500 K	3200	295 × 1195 x 7.5	270 × 1180	12	\$68,9



LED OPAL LENSİ SLİM BACKLIGHT ARMATÜR

LED SLİM BACKLIGHT ARMATURE - OPAL LENS

Teknik Özellikler

Technical Specifications

Gövde : DKP Sac
Body : DKP Metal Sheet

Gövde Renkleri : Beyaz
Body Colors : White

Difüzör : PMMA
Diffuser : PMMA

Renksel Geri Verim : 80
Color Rendering Index : 80

IP Derecesi : IP20
IP Rating : IP20

IK Derecesi : IK02
IK Rating : IK02

Elektriksel Koruma : Sınıf II
Electrical Protection : Class II

Çalışma Sıcaklığı : -20°C / 45°C
Operating Temp.Range : -20°C / 45°C



LED

3
YIL
GARANTİ

50.000
SAAT

LED OPAL LENSİ SLİM BACKLIGHT ARMATÜR

Alçıpan tavan çeşitleri ile uyumlu gövde yapısı, tüm iç mekanların genel aydınlatma ihtiyacını karşılamak için idealdir. Optimum ışık geçirgenliğine ve homojen yayılmaya sahip, sararma ve renk değiştirmeyen opal lens difüzörü ile fark yaratır.

LED SLİM BACKLIGHT ARMATURE - OPAL LENS

The body structure compatible with plasterboard ceiling types is ideal for meeting the general lighting needs of all interior spaces. It makes a difference with its opal lens diffuser, which has an optimum light transmission and homogeneous spread, which does not turn yellow or change colour.



LED OPAL LENSİ SLİM BACKLIGHT ARMATÜR

LED SLİM BACKLIGHT ARMATURE - OPAL LENS

Enerji Verimliliği Sınıfı Energy Efficiency Class	Ürün Kodu Product Code	Güç (W) Power	Renk Sıcaklığı (K) Color Temperature	Işık Akısı (Lm) Luminous Flux	Boyutlar (WxLxH) mm Dimensions	Koli Adeti Quantity in Carton	Fiyat Price
A++ F	BL-O2-3008	15W	3000 K	1350	295 × 295 × 35	12	\$18,3
A++ F	BL-O2-3009	15W	4000 K	1350	296 × 295 × 35	12	\$18,3
A++ F	BL-O2-3010	15W	6500 K	1350	297 × 295 × 35	12	\$18,3
A++ F	BL-O2-2011	40W	3000 K	3600	595 × 595 × 35	6	\$29,0
A++ F	BL-O2-2012	40W	4000 K	3600	595 × 595 × 35	6	\$29,0
A++ F	BL-O2-2013	40W	6500 K	3600	595 × 595 × 35	6	\$29,0

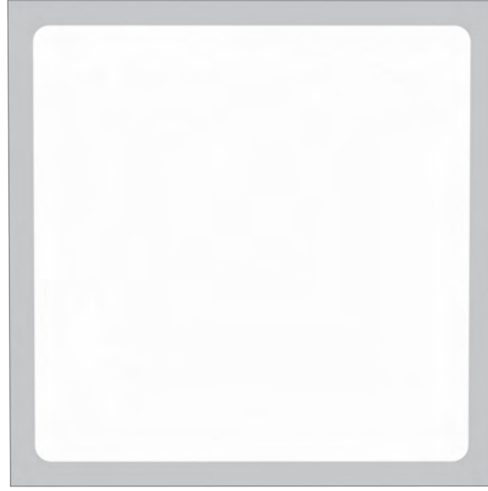

LED OPAL LENSİ SLİM BACKLIGHT ARMATÜR TSE

LED SLİM BACKLIGHT ARMATURE - OPAL LENS TSE

Teknik Özellikler Technical Specifications

Gövde : DKP Sac
Body : DKP Metal Sheet

Gövde Renkleri : Beyaz
Body Colors : White

Difüzör : PMMA
Diffuser : PMMA

Renksel Geri Verim : 80
Color Rendering Index : 80

IP Derecesi : IP20
IP Rating : IP20

IK Derecesi : IK02
IK Rating : IK02

Elektriksel Koruma : Sınıf II
Electrical Protection : Class II

Çalışma Sıcaklığı : -20°C / 45°C
Operating Temp.Range : -20°C / 45°C



LED

3
YIL
GARANTİ

50.000
SAAT

LED OPAL LENSİ SLİM BACKLIGHT ARMATÜR

Alçıpan tavan çeşitleri ile uyumlu gövde yapısı, tüm iç mekanların genel aydınlatma ihtiyacını karşılamak için idealdir. Optimum ışık geçirgenliğine ve homojen yayılmaya sahip, sararma ve renk değiştirmeyen opal lens difüzörü ile fark yaratır.

LED SLİM BACKLIGHT ARMATURE - OPAL LENS

The body structure compatible with plasterboard ceiling types is ideal for meeting the general lighting needs of all interior spaces. It makes a difference with its opal lens diffuser, which has an optimum light transmission and homogeneous spread, which does not turn yellow or change colour.



LED OPAL LENSİ SLIM BACKLIGHT ARMATÜR TSE

LED SLIM BACKLIGHT ARMATURE - OPAL LENS TSE

Enerji Verimliliği Sınıfı Energy Efficiency Class	Ürün Kodu Product Code	Güç (W) Power	Renk Sıcaklığı (K) Color Temperature	Işık Akısı (Lm) Luminous Flux	Boyutlar (WxLxH) mm Dimensions	Koli Adeti Quantity in Carton	Fiyat Price
	BLT-O2-3008	15W	3000 K	1350	295 × 295 × 35	12	\$33,30
	BLT-O2-3009	15W	4000 K	1350	296 × 295 × 35	12	\$33,30
	BLT-O2-3010	15W	6500 K	1350	297 × 295 × 35	12	\$33,30
	BLT-O2-2011	40W	3000 K	3600	595 × 595 × 35	6	\$43,90
	BLT-O2-2012	40W	4000 K	3600	595 × 595 × 35	6	\$43,90
	BLT-O2-2013	40W	6500 K	3600	595 × 595 × 35	6	\$43,90

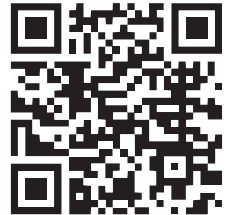
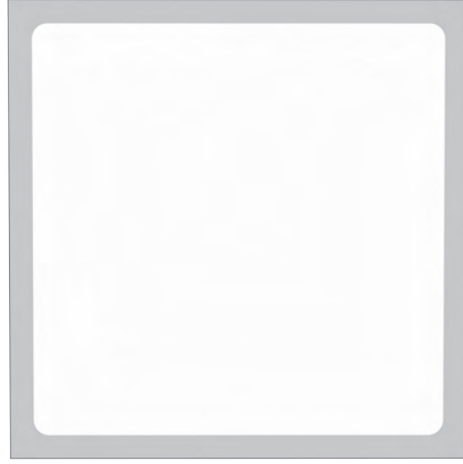

Teknik veri / Datasheet

LED OPAL LENSİ BACKLIGHT ARMATÜR

LED BACKLIGHT ARMATURE - OPAL LENS

Teknik Özellikler

Technical Specifications

Gövde : DKP Sac
Body : DKP Metal Sheet

Gövde Renkleri : Beyaz
Body Colors : White

Difüzör : Akriklik (PMMA)
Diffuser : Acrylic (PMMA)

Sürücü : Eaglerise/Osram/Tridonic
Driver : Eaglerise/Osram/Tridonic

Renksel Geri Verim : 80
Color Rendering Index : 80

IP Derecesi : IP20
IP Rating : IP20

IK Derecesi : IK03
IK Rating : IK03

Elektriksel Koruma : Sınıf I
Electrical Protection : Class I

Çalışma Sıcaklığı : -20°C / 45°C
Operating Temp. Range : -20°C / 45°C



LED OPAL LENSİ BACKLIGHT ARMATÜR

Alçıpan tavan çeşitleri ile uyumlu gövde yapısı ve harici siva üstü çerçeveler sayesinde tüm iç mekanların genel aydınlatma ihtiyacını karşılamak için idealdir. Optimum ışık geçirgenliğine ve homojen yayılmaya sahip, sararma ve renk değiştirmeyen opal lens difüzörü ile fark yaratır.

LED BACKLIGHT ARMATURE - OPAL LENS

It is ideal for meeting the general lighting needs of all interior spaces thanks to its body structure compatible with plasterboard ceiling types and external surface-mounted frames. It makes a difference with its opal lens diffuser, which has optimum light transmittance and homogeneous spread that does not turn yellow and does not change colour.



LED OPAL LENSLİ BACKLIGHT SIVA ALTI ARMATÜR

LED FLUSH MOUNTED BACKLIGHT ARMATURE - OPAL LENS

Enerji Verimliliği Sınıfı Energy Efficiency Class	Ürün Kodu Product Code	Güç (W) Power	Renk Sıcaklığı (K) Color Temperature	Işık Akısı (Lm) Luminous Flux	Boyutlar (WxLxH) mm Dimensions	Koli Adeti Quantity in Carton	Fiyat Price
	BLT-O2-2005	12W	4000 K	1575	300 × 300 × 65	8	\$48,3
	BLT-O2-2006	12W	6500 K	1575	300 × 300 × 65	8	\$48,3
	BLT-O6-0002	24W	4000 K	2750	300 × 600 × 65	4	\$81,8
	BLT-O6-0003	24W	6500 K	2750	300 × 600 × 65	4	\$81,8
	BLT-O2-2002	36W	4000 K	4500	600 × 600 × 65	2	\$89,2
	BLT-O2-2003	36W	6500 K	4500	600 × 600 × 65	2	\$89,2

LED OPAL LENSLİ BACKLIGHT SIVA ÜSTÜ ARMATÜR

LED SURFACE MOUNTED BACKLIGHT ARMATURE - OPAL LENS

Enerji Verimliliği Sınıfı Energy Efficiency Class	Ürün Kodu Product Code	Güç (W) Power	Renk Sıcaklığı (K) Color Temperature	Işık Akısı (Lm) Luminous Flux	Boyutlar (WxLxH) mm Dimensions	Koli Adeti Quantity in Carton	Fiyat Price
	BLT-O5-2005	12W	4000 K	1575	300 × 300 × 65	8	\$60,3
	BLT-O5-2006	12W	6500 K	1575	300 × 300 × 65	8	\$60,3
	BLT-O6-1002	24W	4000 K	2750	300 × 600 × 65	4	\$101,9
	BLT-O6-1003	24W	6500 K	2750	300 × 600 × 65	4	\$101,9
	BLT-O5-2008	36W	4000 K	4500	600 × 600 × 65	2	\$100,6
	BLT-O5-2009	36W	6500 K	4500	600 × 600 × 65	2	\$100,6

LED OPAL LENSLİ BACKLIGHT CLIP-IN ARMATÜR

LED BACKLIGHT CLIP-IN ARMATURE - OPAL LENS

Enerji Verimliliği Sınıfı Energy Efficiency Class	Ürün Kodu Product Code	Güç (W) Power	Renk Sıcaklığı (K) Color Temperature	Işık Akısı (Lm) Luminous Flux	Boyutlar (WxLxH) mm Dimensions	Koli Adeti Quantity in Carton	Fiyat Price
	BLT-O2-3011	20W	4000 K	2000	300 × 300 × 65	8	\$55,9
	BLT-O2-3012	20W	6500 K	2000	300 × 300 × 65	8	\$55,9
	BLT-O6-2002	24W	4000 K	2750	300 × 600 × 65	4	\$101,9
	BLT-O6-2003	24W	6500 K	2750	300 × 600 × 65	4	\$101,9
	BLT-O2-2008	36W	4000 K	4500	600 × 600 × 65	2	\$78,6
	BLT-O2-2009	36W	6500 K	4500	600 × 600 × 65	2	\$78,6



Teknik veri / Datasheet

LED BACKLIGHT STERIL ORTAM ARMATÜR

LED BACKLIGHT STERILE AMBIENT ARMATURE

Teknik Özellikler

Technical Specifications

Gövde : DKP Sac
Body : DKP Metal Sheet

Gövde Renkleri : Beyaz
Body Colors : White

Difüzör : Temperli Cam
Diffuser : Tempered Glass

Renksel Geri Verim : 80
Color Rendering Index : 80

IP Derecesi : IP65
IP Rating : IP65

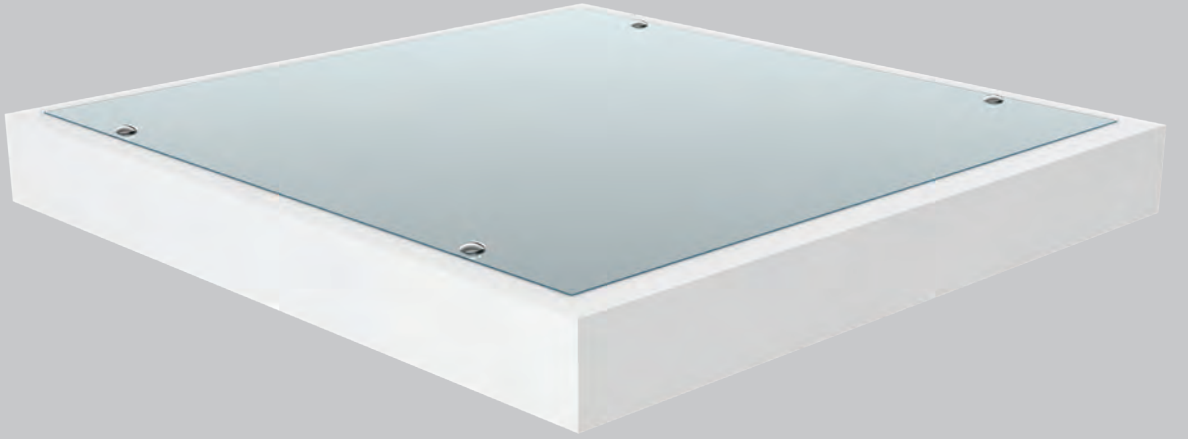
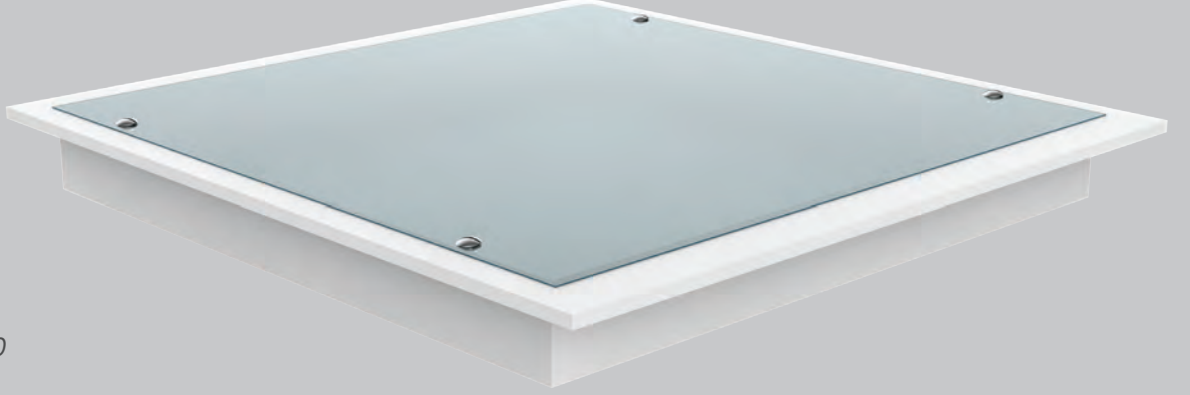

LED

3
YIL
GARANTİ

50.000
SAAT

IP65

LED BACKLIGHT STERIL ORTAM ARMATÜR

Temperli cam çerçevesi ile bireysel ve homojen aydınlatma sağlayan steril ortam armatürüdür. Verimli ve hijyen aydınlatma gerektiren tüm iç mekanlar, hastaneler, laboratuvarlar, klinikler, eczaneler, temiz odalar, gıda hazırlama alanları gibi yerler için idealdir.

LED BACKLIGHT STERILE AMBIENT ARMATURE

It is a sterile environment luminaire that provides individual and homogeneous lighting with its tempered glass frame. All interior spaces require efficient and hygienic lighting. Ideal for hospitals, laboratories, clinics, pharmacies, clean rooms, food preparation areas.



LED BACKLIGHT STERIL ORTAM SIVA ALTI ARMATÜR

LED BACKLIGHT STERILE AMBIENT ARMATURE

Enerji Verimliliği Sınıfı Energy Efficiency Class	Ürün Kodu Product Code	Güç (W) Power	Renk Sıcaklığı (K) Color Temperature	Işık Akısı (Lm) Luminous Flux	Boyutlar (WxLxH) mm Dimensions	Koli Adeti Quantity in Carton	Fiyat Price
	BL-O2-3001	15W	4000 K	2160	300 × 300 × 110	1	\$136,2
	BL-O2-3002	15W	6500 K	2160	300 × 300 × 110	1	\$136,2
	BL-O2-4001	35W	4000 K	4200	600 × 600 × 100	1	\$216,1
	BL-O2-4002	35W	6500 K	4200	600 × 600 × 100	1	\$216,1

LED BACKLIGHT STERIL ORTAM SIVA ÜSTÜ ARMATÜR

LED BACKLIGHT STERILE AMBIENT ARMATURE

Enerji Verimliliği Sınıfı Energy Efficiency Class	Ürün Kodu Product Code	Güç (W) Power	Renk Sıcaklığı (K) Color Temperature	Işık Akısı (Lm) Luminous Flux	Boyutlar (WxLxH) mm Dimensions	Koli Adeti Quantity in Carton	Fiyat Price
	BL-O5-3001	15W	4000 K	2160	300 × 300 × 110	1	\$146,3
	BL-O5-3002	15W	6500 K	2160	300 × 300 × 110	1	\$146,3
	BL-O5-4001	35W	4000 K	4200	600 × 600 × 100	1	\$231,5
	BL-O5-4002	35W	6500 K	4200	600 × 600 × 100	1	\$231,5

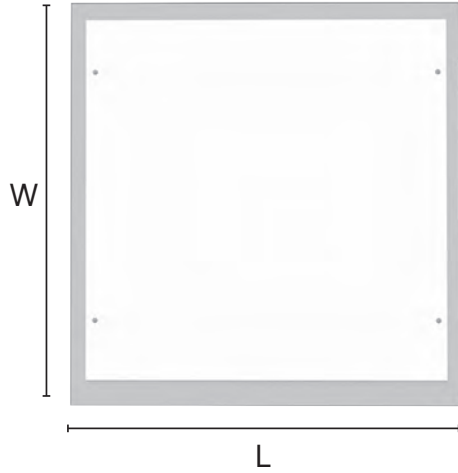

LED PROJKTÖR PLATİN SERİSİ

LED FLOODLIGHT PROJECTOR PLATINUM SERIES

Teknik Özellikler

Technical Specifications

Gövde : Alüminyum
Body : Aluminium

Cam : Temperli Cam
Glass : Tempered Glass

Renksel Geri Verim : 70
Color Rendering Index : 70

IP Derecesi : IP65
IP Rating : IP65

IK Derecesi : IK08
IK Rating : IK08

Elektriksel Koruma : Sınıf I
Electrical Protection : Class I



LED

3 YIL GARANTİ

50.000 SAAT

IP65

LED PROJKTÖR PLATİN SERİSİ

Led Projektörleri uzun mesafeli açık alanlarda, şehir meydanlarında, spor sahalarında, fabrika ve tesislerin aydınlatması vb birçok alanda rahatlıkla tercih edebilirsiniz. Darbelere dayanıklı, su ve toz geçirmez. IP65 standartlarına uygundur. Enerji tasarrufu, güvenilir performans ve uzun ömürlü kullanım sağlar.

LED FLOODLIGHT PROJECTOR PLATINUM SERIES

You can easily choose Led Floodlight Projectors in long-distance open areas, city squares, sports fields, lighting of factories and facilities, etc. Shockproof, waterproof and dustproof. It complies with IP65 standards. It provides energy-saving, reliable performance and long-lasting use.



LED PROJKTÖR PLATİN SERİSİ

LED FLOODLIGHT PROJECTOR PLATINUM SERIES

Enerji Verimliliği Sınıfı Energy Efficiency Class	Ürün Kodu Product Code	Güç (W) Power	Renk Sıcaklığı (K) Color Temperature	Işık Akısı (Lm) Luminous Flux	Boyutlar (WxLxH) mm Dimensions	Renk Color	Koli Adeti Quantity in Carton	Fiyat Price
A+ F	BL-P2-0001	10W	6500 K	800	87 × 115 × 32	Siyah	32	\$11,8
A+ F	BL-P2-0002	10W	4000 K	800	87 × 115 × 32	Siyah	32	\$11,8
A+ F	BL-P2-0003	10W	3000 K	800	87 × 115 × 32	Siyah	32	\$11,8
A+ F	BL-P2-0004	20W	6500 K	1600	107 × 137 × 32	Siyah	32	\$17,0
A+ F	BL-P2-0005	20W	4000 K	1600	107 × 137 × 32	Siyah	32	\$17,0
A+ F	BL-P2-0006	20W	3000 K	1600	107 × 137 × 32	Siyah	32	\$17,0
A+ F	BL-P2-0007	30W	6500 K	2400	140 × 180 × 33	Siyah	16	\$25,5
A+ F	BL-P2-0008	30W	4000 K	2400	140 × 180 × 33	Siyah	16	\$25,5
A+ F	BL-P2-0009	30W	3000 K	2400	140 × 180 × 33	Siyah	16	\$25,5
A+ F	BL-P2-0010	50W	6500 K	4000	185 × 227 × 36	Siyah	10	\$35,7
A+ F	BL-P2-0011	50W	4000 K	4000	185 × 227 × 36	Siyah	10	\$35,7
A+ F	BL-P2-0012	50W	3000 K	4000	185 × 227 × 36	Siyah	10	\$35,7
A+ F	BL-P2-0013	70W	6500 K	5600	240 × 290 × 40	Siyah	5	\$57,2
A+ F	BL-P2-0014	70W	4000 K	5600	240 × 290 × 40	Siyah	5	\$57,2
A+ F	BL-P2-0015	70W	3000 K	5600	240 × 290 × 40	Siyah	5	\$57,2
A+ F	BL-P2-0016	100W	6500 K	8000	240 × 290 × 40	Siyah	5	\$66,2
A+ F	BL-P2-0017	100W	4000 K	8000	240 × 290 × 40	Siyah	5	\$66,2
A+ F	BL-P2-0018	100W	3000 K	8000	240 × 290 × 40	Siyah	5	\$66,2
A+ F	BL-P2-0019	150W	6500 K	12000	290 × 370 × 61	Siyah	3	\$112,1
A+ F	BL-P2-0020	150W	4000 K	12000	290 × 370 × 61	Siyah	3	\$112,1
A+ F	BL-P2-0021	150W	3000 K	12000	290 × 370 × 61	Siyah	3	\$112,1
A+ F	BL-P2-0022	200W	6500 K	16000	310 × 440 × 65	Siyah	3	\$147,5
A+ F	BL-P2-0023	200W	4000 K	16000	310 × 440 × 65	Siyah	3	\$147,5
A+ F	BL-P2-0024	200W	3000 K	16000	310 × 440 × 65	Siyah	3	\$147,5

W

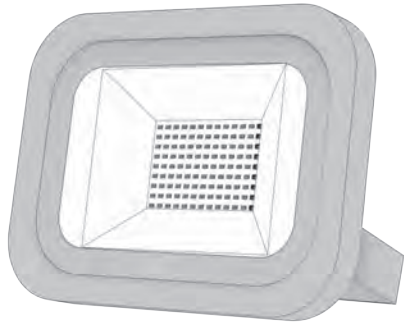

L



H



LED PROJKTÖR PLATIN SERISI

LED FLOODLIGHT PROJECTOR PLATINUM SERIES

Teknik Özellikler Technical Specifications

Gövde : Alüminyum
Body : Aluminium

Cam : Temperli Cam
Glass : Tempered Glass

Renksel Geri Verim : 70
Color Rendering Index : 70

IP Derecesi : IP65
IP Rating : IP65

IK Derecesi : IK08
IK Rating : IK08

Elektriksel Koruma : Sınıf I
Electrical Protection : Class I



LED

3 YIL
GARANTİ

50.000
SAAT

IP65



SENSÖRLÜ LED PROJKTÖR PLATİN SERİSİ

Ayarlanabilir hareket sensörü ile önemli miktarda enerji tasarrufu, güvenilir performans ve uzun ömürlü kullanım sağlar. IP65 standartlarına uygun olarak darbelere dayanıklı, su ve toz geçirmez.

SENSOR LED FLOODLIGHT PROJECTOR PLATINUM SERIES

With its adjustable motion sensor, it provides significant energy savings, reliable performance and long-lasting use.

Shockproof, waterproof and dustproof in accordance with IP65 standards.

YEŞİL LED PROJKTÖR PLATİN SERİSİ

Peyzaj mimarisinde, çevre ve mekanların estetik aydınlatılmasına uygundur. Enerji tasarrufu, güvenilir performans ve uzun ömürlü kullanım sağlar. IP65 standartlarına uygun olarak darbelere dayanıklı, su ve toz geçirmez.

GREEN LED FLOODLIGHT PROJECTOR PLATINUM SERIES

In landscape architecture, it is suitable for the aesthetic lighting of the environment and spaces. It provides energy-saving, reliable performance and long-lasting use. Shockproof, waterproof and dustproof by IP65 standards.



SENSÖRLÜ LED PROJEKTÖR PLATIN SERİSİ

SENSOR LED FLOODLIGHT PROJECTOR PLATINUM SERIES

Enerji Verimliliği Sınıfı Energy Efficiency Class	Ürün Kodu Product Code	Güç (W) Power	Renk Sıcaklığı (K) Color Temperature	Işık Akısı (Lm) Luminous Flux	Boyutlar (WxLxH) mm Dimensions	Renk Color	Koli Adeti Quantity in Carton	Fiyat Price
A+G F	BL-P2-0001-S	10W	6500 K	800	87 × 115 × 32	Siyah	32	\$25,0
A+G F	BL-P2-0003-S	10W	3000 K	800	87 × 115 × 32	Siyah	32	\$25,0
A+G F	BL-P2-0004-S	20W	6500 K	1600	107 × 137 × 32	Siyah	32	\$30,1
A+G F	BL-P2-0006-S	20W	3000 K	1600	107 × 137 × 32	Siyah	32	\$30,1
A+G F	BL-P2-0007-S	30W	6500 K	2400	140 × 180 × 33	Siyah	16	\$39,4
A+G F	BL-P2-0009-S	30W	3000 K	2400	140 × 180 × 33	Siyah	16	\$39,4
A+G F	BL-P2-0010-S	50W	6500 K	4000	185 × 227 × 36	Siyah	10	\$51,1
A+G F	BL-P2-0012-S	50W	3000 K	4000	185 × 227 × 36	Siyah	10	\$51,1

YEŞİL LED PROJEKTÖR PLATIN SERİSİ

GREEN LED FLOODLIGHT PROJECTOR PLATINUM SERIES

Enerji Verimliliği Sınıfı Energy Efficiency Class	Ürün Kodu Product Code	Güç (W) Power	Renk Sıcaklığı (K) Color Temperature	Işık Akısı (Lm) Luminous Flux	Boyutlar (WxLxH) mm Dimensions	Renk Color	Koli Adeti Quantity in Carton	Fiyat Price
A+G F	BL-P2-1GRN	10W	Yeşil Green	800	87 × 115 × 32	Siyah	32	\$11,8
A+G F	BL-P2-2GRN	20W	Yeşil Green	1600	107 × 137 × 32	Siyah	32	\$18,0
A+G F	BL-P2-3GRN	30W	Yeşil Green	2400	140 × 180 × 33	Siyah	16	\$26,2
A+G F	BL-P2-5GRN	50W	Yeşil Green	4000	185 × 227 × 36	Siyah	10	\$36,2

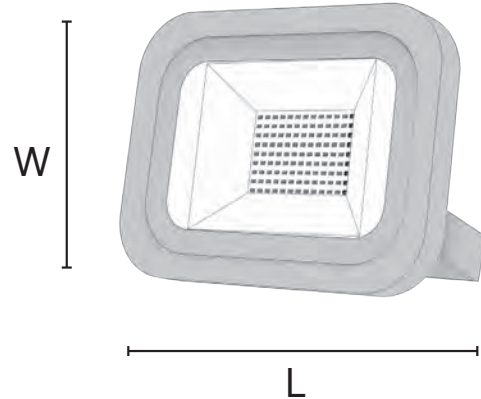
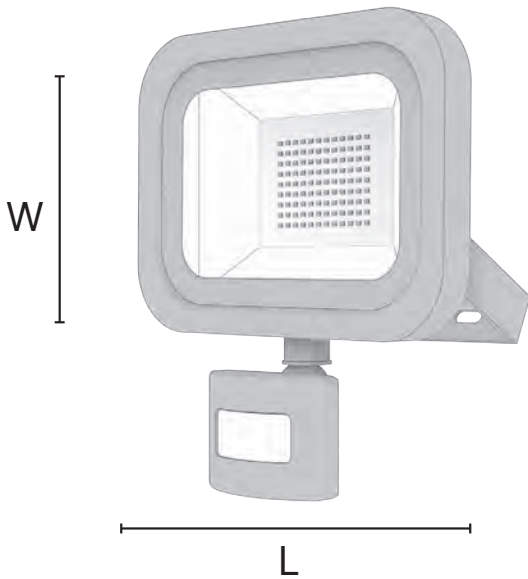

LED PROJKTÖR GOLD SERİSİ

LED FLOODLIGHT PROJECTOR GOLD SERIES

Teknik Özellikler Technical Specifications

Gövde : Alüminyum
Body : Aluminium

Cam : Temperli Cam
Glass : Tempered Glass

Renksel Geri Verim : 80
Color Rendering Index : 80

IP Derecesi : IP65
IP Rating : IP65

IK Derecesi : IK08
IK Rating : IK08

Elektriksel Koruma : Sınıf I
Electrical Protection : Class I

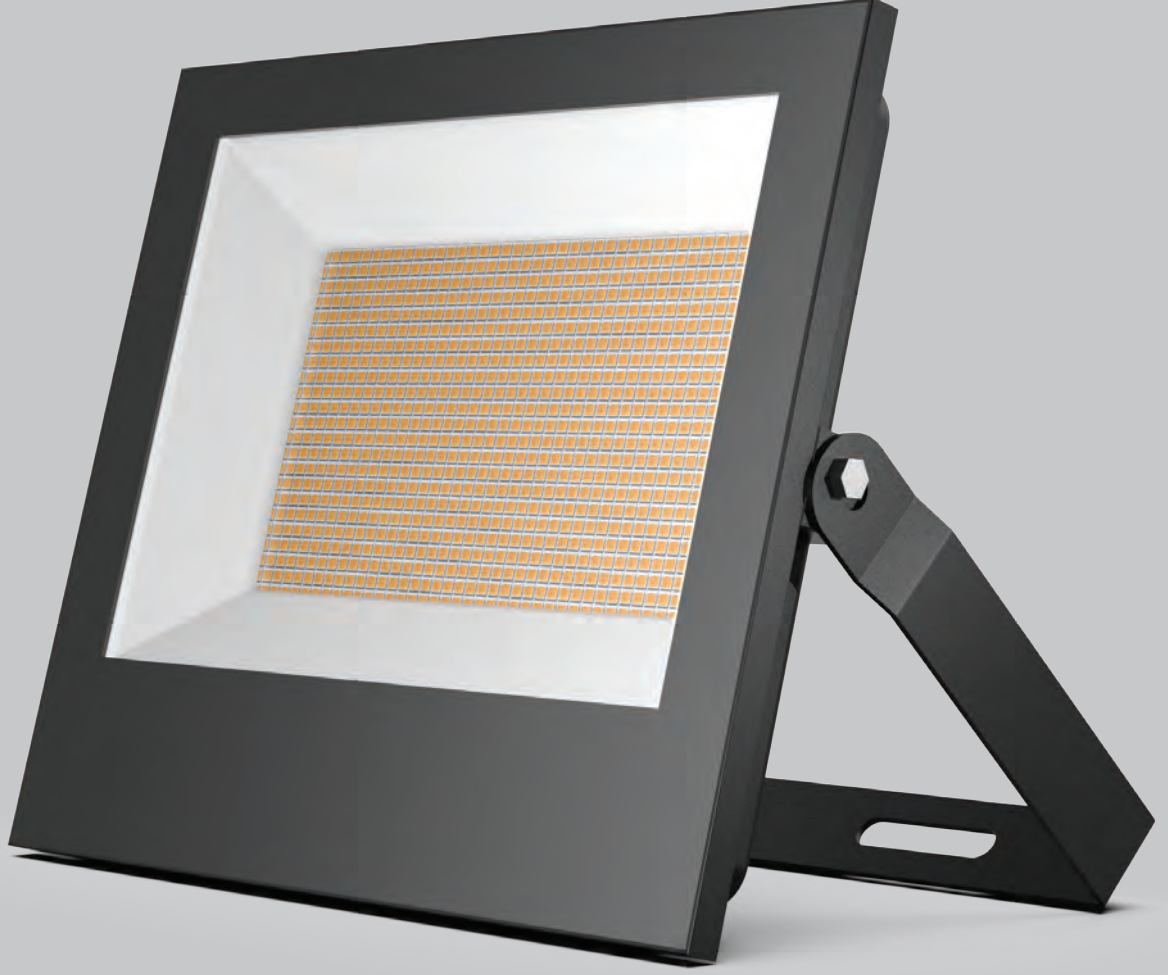

LED

2 YIL
GARANTİ

50.000
SAAT

IP65

LED PROJKTÖR GOLD SERİSİ

Led Projektörleri uzun mesafeli açık alanlarda, şehir meydanlarında, spor sahalarında, fabrika ve tesislerin aydınlatması vb birçok alanda rahatlıkla tercih edebilirsiniz. Darbelere dayanıklı, su ve toz geçirmez. IP65 standartlarına uygundur. Enerji tasarrufu, güvenilir performans ve uzun ömürlü kullanım sağlar.

LED FLOODLIGHT PROJECTOR GOLD SERIES

You can easily choose Led Floodlight Projectors in long-distance open areas, city squares, sports fields, lighting of factories and facilities, etc. Shockproof, waterproof and dustproof. It complies with IP65 standards. It provides energy-saving, reliable performance and long-lasting use.



LED PROJKTÖR GOLD SERİSİ

LED FLOODLIGHT PROJECTOR GOLD SERIES

Enerji Verimliliği Sınıfı Energy Efficiency Class	Ürün Kodu Product Code	Güç (W) Power	Renk Sıcaklığı (K) Color Temperature	Işık Akısı (Lm) Luminous Flux	Boyutlar (WxLxH) mm Dimensions	Renk Color	Koli Adeti Quantity in Carton	Fiyat Price
A+ F	BL-P4-0001	10W	3000 K	800	69 × 98 × 25	Siyah-Black	36	\$8,6
A+ F	BL-P4-0003	10W	6500 K	800	69 × 98 × 25	Siyah-Black	36	\$8,6
A+ F	BL-P4-0004	20W	3000 K	1600	92 × 123 × 28	Siyah-Black	36	\$12,1
A+ F	BL-P4-0006	20W	6500 K	1600	92 × 123 × 28	Siyah-Black	36	\$12,1
A+ F	BL-P4-0007	30W	3000 K	2400	117 × 157 × 28	Siyah-Black	32	\$16,9
A+ F	BL-P4-0009	30W	6500 K	2400	117 × 157 × 28	Siyah-Black	32	\$16,9
A+ F	BL-P4-0010	50W	3000 K	4000	144 × 202 × 28	Siyah-Black	16	\$23,6
A+ F	BL-P4-0012	50W	6500 K	4000	144 × 202 × 28	Siyah-Black	16	\$23,6
A+ F	BL-P4-0013	70W	3000 K	5600	186 × 241 × 28	Siyah-Black	10	\$33,5
A+ F	BL-P4-0015	70W	6500 K	5600	186 × 241 × 28	Siyah-Black	10	\$33,5
A+ F	BL-P4-0016	100W	3000 K	8000	206 × 266 × 30	Siyah-Black	10	\$47,7
A+ F	BL-P4-0018	100W	6500 K	8000	206 × 266 × 30	Siyah-Black	10	\$47,7
A+ F	BL-P4-0019	150W	3000 K	12000	230 × 326 × 32	Siyah-Black	5	\$71,8
A+ F	BL-P4-0021	150W	6500 K	12000	230 × 326 × 32	Siyah-Black	5	\$71,8
A+ F	BL-P4-0022	200W	3000 K	16000	247 × 350 × 34	Siyah-Black	5	\$100,3
A+ F	BL-P4-0024	200W	6500 K	16000	247 × 350 × 34	Siyah-Black	5	\$100,3
A+ F	BL-P4-0025	300W	3000 K	24000	356 × 470 × 36,5	Siyah-Black	2	\$209,5
A+ F	BL-P4-0027	300W	6500 K	24000	356 × 470 × 36,5	Siyah-Black	2	\$209,5
A+ F	BL-P4-0028	400W	3000 K	32000	386 × 518 × 77	Siyah-Black	2	\$291,5
A+ F	BL-P4-0030	400W	6500 K	32000	386 × 518 × 77	Siyah-Black	2	\$291,5

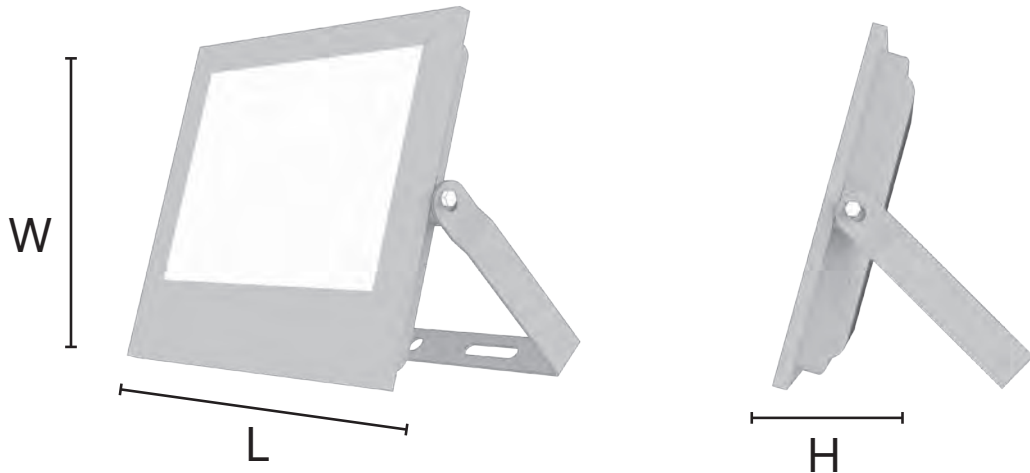

LED YÜKSEK TAVAN SPOTLARI LED HIGHBAY

Teknik Özellikler Technical Specifications

Gövde : Alüminyum
Body : Aluminium

Cam: Polikarbon Cam
Glass: Polycarbon Glass

Sürücü: İzole Sürücü
Driver: Isolated Driver

Giriş Gerilimi : 100-265 V AC
Input Voltage: 100-265 V AC

Renksel Geri Verim: 80
Color Rendering Index: 80

IP Derecesi : IP65
IP Rating : IP65

Çalışma Sıcaklığı : -40°C / 45°C
Operating Temp. Range : -40°C / 45°C



LED

3 YIL
GARANTİ

50.000
SAAT

IP65

LED YÜKSEK TAVAN SPOTLARI ONBOARD LED HIGHBAY ONBOARD

Teknik Özellikler Technical Specifications

Gövde : Alüminyum
Body : Aluminium

Cam: Polikarbon Cam
Glass: Polycarbon Glass

Sürücü: On-Board
Driver: DOB

Giriş Gerilimi : 100-265 V AC
Input Voltage: 100-265 V AC

Renksel Geri Verim: 80
Color Rendering Index: 80

IP Derecesi : IP65
IP Rating : IP65

Çalışma Sıcaklığı : -40°C / 45°C
Operating Temp. Range : -40°C / 45°C



LED HIGHBAY

Led yüksek tavan spotları atölye, ticari, depo aydınlatması vb. için çok uygundur. Tasarım yapısı uzun ömürlü, verimli ve parlaktır. Su, toz geçirmez IP65 koruma daha kolay temizlik ve bakım sağlar.

LED HIGHBAY ONBOARD

Led high bay spotlights are very suitable for workshop, commercial, warehouse lighting etc. The design structure is long life, efficient and bright. Water, dustproof IP65 protection makes easier cleaning and maintenance.



LED YÜKSEK TAVAN SPOTLARI LED HIGHBAY

Enerji Verimliliği Sınıfı Energy Efficiency Class	Ürün Kodu Product Code	Güç (W) Power	Renk Sıcaklığı (K) Color Temperature	Işık Akısı (Lm) Luminous Flux	Boyutlar (ØxH) mm Dimensions	Koli Adeti Quantity in Carton	Fiyat Price
	BL-HB-0001	100W	3000 K	10.000	250 X 100	1	\$84,6
	BL-HB-0002	100W	6500 K	10.000	250 X 100	1	\$84,6
	BL-HB-0003	150W	3000 K	15.000	290 X 100	1	\$113,6
	BL-HB-0004	150W	6500 K	15.000	290 X 100	1	\$113,6
	BL-HB-0005	200W	3000 K	20.000	355 X 100	1	\$138,3
	BL-HB-0006	200W	6500 K	20.000	355 X 100	1	\$138,3

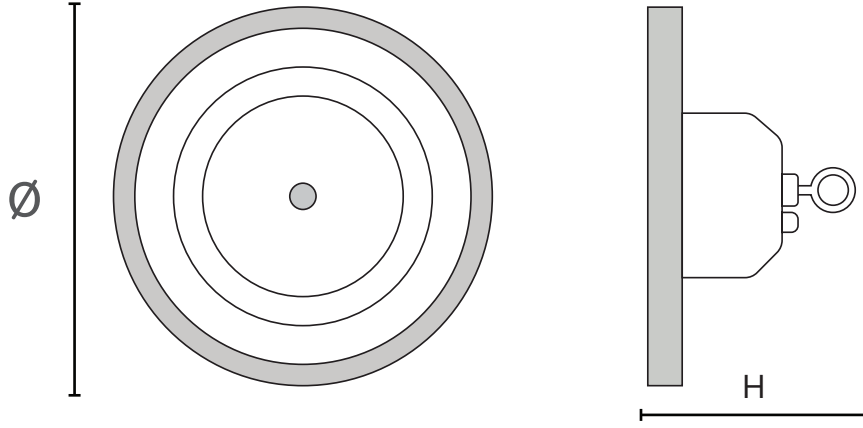

LED YÜKSEK TAVAN SPOTLARI ONBOARD LED HIGHBAY ONBOARD

Enerji Verimliliği Sınıfı Energy Efficiency Class	Ürün Kodu Product Code	Güç (W) Power	Renk Sıcaklığı (K) Color Temperature	Işık Akısı (Lm) Luminous Flux	Boyutlar (ØxH) mm Dimensions	Koli Adeti Quantity in Carton	Fiyat Price
	BL-HB-1001	100W	3000 K	10.000	270 X 42	1	\$50,4
	BL-HB-1002	100W	6500 K	10.000	270 X 42	1	\$50,4
	BL-HB-1003	150W	3000 K	15.000	311 X 42	1	\$69,3
	BL-HB-1004	150W	6500 K	15.000	311 X 42	1	\$69,3
	BL-HB-1005	200W	3000 K	20.000	383 X 42	1	\$89,5
	BL-HB-1006	200W	6500 K	20.000	383 X 42	1	\$89,5

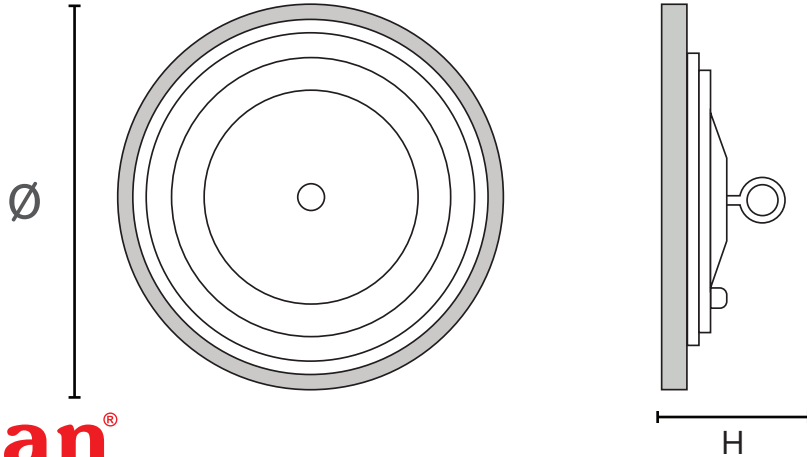

LED SOKAK AYDINLATMA ARMATÜRÜ

LED STREET LIGHTING ARMATURE

Teknik Özellikler

Technical Specifications

Gövde : Alüminyum
Body : Aluminium

Cam : Polikarbonat Cam
Glass : Polycarbonate Glass

Renksel Geri Verim : 70
Color Rendering Index : 70

IP Derecesi : IP65
IP Rating : IP65

IK Derecesi : IK07
IK Rating : IK07

Elektriksel Koruma : Sınıf I
Electrical Protection : Class I



LED

3
YIL
GARANTİ

50.000
SAAT

IP65

LED SOKAK AYDINLATMA ARMATÜRÜ

Led Şehir Aydınlatma Armatürleri, yayalar ve sürücüler için azami görüş konforu ve yol güvenliği sağlar.

Sodyum ve cıva içeren lambalara göre düşük enerji gereksinimi, yüksek renksel geri verim, farklı renk sıcaklık seçenekleri, DIM ayar ve zamanlama otomasyon avantajlarına sahiptir. İlave olarak estetik ve kompakt armatür yapısı ile darbelere ve şoka dayanıklıdır. Uzun ömürlü ve bakım maliyetleri düşüktür.

LED STREET LIGHTING ARMATURE

Led City Lighting Fixtures to provide maximum visibility comfort and road safety for pedestrians and drivers.

Compared to lamps containing sodium and mercury, it has the advantages of low energy requirement, high colour rendering, different colour temperature options, DIM adjustment and timing automation. In addition, it is resistant to impacts and shocks with its aesthetic and compact armature structure, long life and low maintenance costs.



LED SOKAK AYDINLATMA ARMATÜRÜ

LED STREET LIGHTING ARMATURE

Enerji Verimliliği Sınıfı Energy Efficiency Class	Ürün Kodu Product Code	Güç (W) Power	Renk Sıcaklığı (K) Color Temperature	Işık Akısı (Lm) Luminous Flux	Boyutlar (WxLxH) mm Dimensions	Renk Color	Koli Adeti Quantity in Carton	Fiyat Price
	BL-C2-2001	60W	3000 K	5400	150 × 400 × 63	Gri	4	\$89,4
	BL-C2-2007	60W	4000 K	5400	150 × 400 × 63	Gri	4	\$89,4
	BL-C2-2002	60W	6500 K	5400	150 × 400 × 63	Gri	4	\$89,4
	BL-C2-2003	90W	3000 K	8100	165 × 465 × 63	Gri	4	\$103,6
	BL-C2-2008	90W	4000 K	8100	165 × 465 × 63	Gri	4	\$103,6
	BL-C2-2004	90W	6500 K	8100	165 × 465 × 63	Gri	4	\$103,6
	BL-C2-2005	120W	3000 K	10800	180 × 585 × 73	Gri	4	\$140,5
	BL-C2-2009	120W	4000 K	10800	180 × 585 × 73	Gri	4	\$140,5
	BL-C2-2006	120W	6500 K	10800	180 × 585 × 73	Gri	4	\$140,5

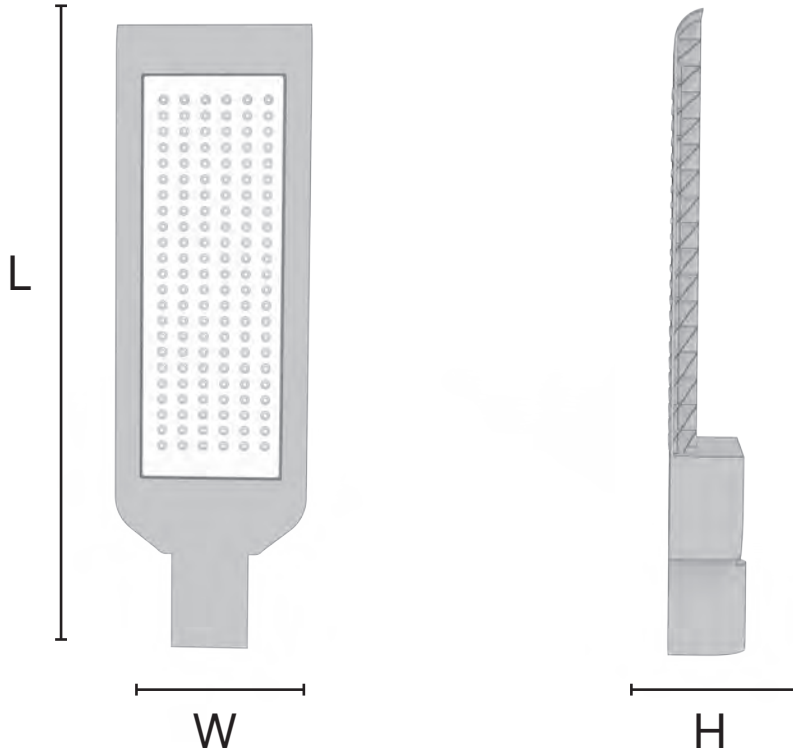

DEKORATİF BAHÇE AYDINLATMA DİREKLERİ DECORATIVE GARDEN LIGHTING POLES

Teknik Özellikler Technical Specifications

Gövde : ABS
Body : ABS

IP Derecesi : IP54
IP Rating : IP54

Kullanım : Tasarruflu/Led Ampul
Usage : Energy Saving/Led Bulb



DEKORATİF BAHÇE AYDINLATMA DİREKLERİ

Zarif ve modern tasarım. Hafif, dayanıklı polimer gövde ve opal difüzör. IP54 Ürün standartları, herhangi bir açıdan katı cisimlere ve su sıçramalarına karşı koruma sağlar. 220-240V şebeke gücü, 1 x E27 (ampul dahil değildir.) Peyzajlı bahçeler, şehir parkları, garaj girişleri ve teras tipi yapılar için ideal, kolay ve hızlı kurulum. Montaj aparatları bu ürünle birlikte verilmektedir.

DECORATIVE GARDEN LIGHTING POLES

Elegant and modern design. Lightweight, durable polymer body and opal diffuser. IP54 Product standards provide protection against solid objects and splashes from any angle. 220-240V mains power, 1 x E27 (bulb not included.) Easy and fast installation, ideal for landscaped gardens, city parks, garage entrances and terrace type structures. Mounting tools are supplied with this product.



DEKORATİF BAHÇE AYDINLATMA DİREKLERİ (MANTAR) (1x27 DUY)

DECORATIVE GARDEN LIGHTING POLES

Ürün Kodu Product Code	Renk Color	Boyutlar (ØxL) cm Dimensions	Gövde Body	Koli Adeti Quantity in Carton	Fiyat Price
BR-BA004	Siyah	11,5 × 29 cm	ABS	1	\$15,40
BR-BA005	Siyah	11,5 × 41 cm	ABS	1	\$16,40

DEKORATİF BAHÇE AYDINLATMA DİREKLERİ (DÜZ) (1x27 DUY)

DECORATIVE GARDEN LIGHTING POLES

Ürün Kodu Product Code	Renk Color	Boyutlar (ØxL) cm Dimensions	Gövde Body	Koli Adeti Quantity in Carton	Fiyat Price
BR-BA006	Siyah	11,5 × 29 cm	ABS	1	\$12,00
BR-BA007	Siyah	11,5 × 41 cm	ABS	1	\$13,00

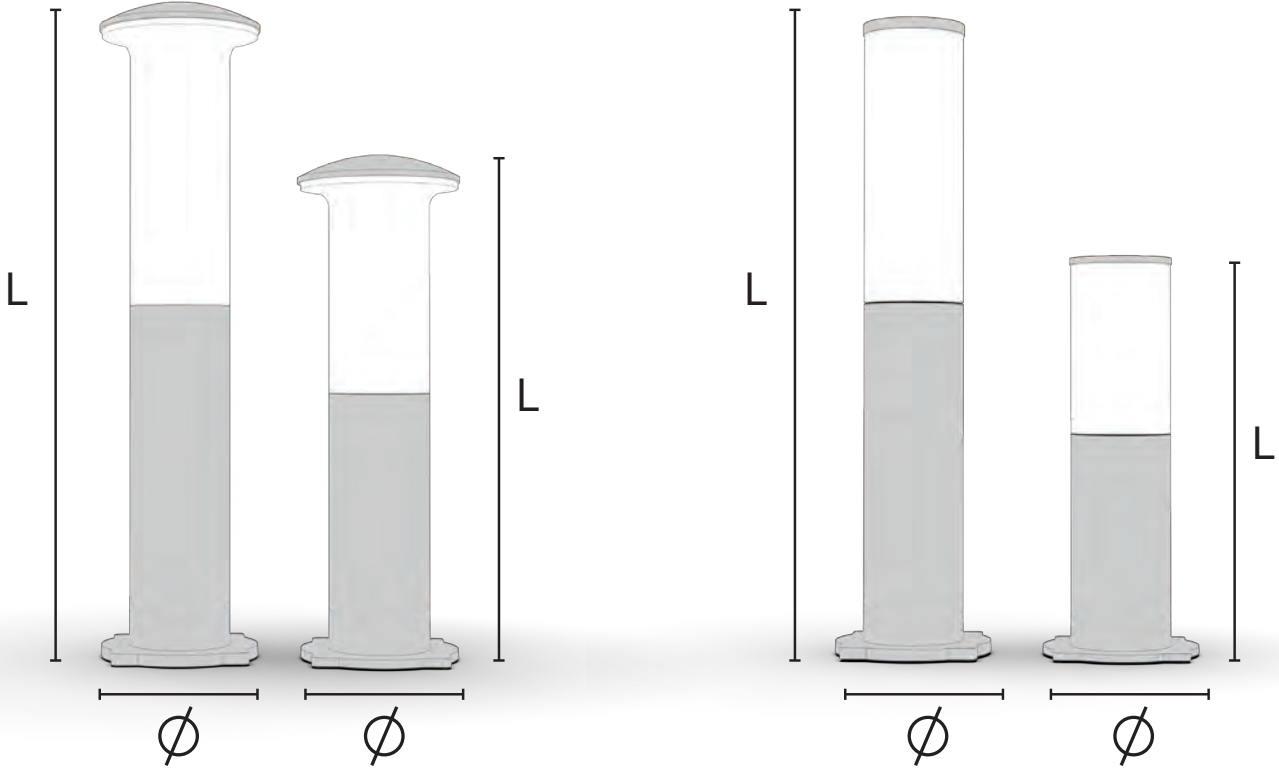

KÜP BAHÇE ARMATÜRÜ (1XE27 DUY) CUBE GARDEN ARMATURE

Teknik Özellikler Technical Specifications

Gövde : ABS
Body : ABS

Gerilim : 220 V AC
Voltage: 220 V AC

Kullanım : Tasarruflu/Led Ampul
Usage : Energy Saving/Led Bulb

IP Derecesi : IP54
IP Rating : IP54

Çalışma Sıcaklığı : -40°C / 45°C
Operating Temp. Range : -40°C / 45°C



LED

3 YIL
GARANTİ

50.000
SAAT

IP54

KÜP BAHÇE ARMATÜRÜ (KAFESLİ) - (1XE27 DUY) CUBE GARDEN ARMATURE (CAGED)

Teknik Özellikler Technical Specifications

Gövde : ABS
Body : ABS

Gerilim : 220 V AC
Voltage: 220 V AC

Kullanım : Tasarruflu/Led Ampul
Usage : Energy Saving/Led Bulb

IP Derecesi : IP54
IP Rating : IP54

Çalışma Sıcaklığı : -40°C / 45°C
Operating Temp. Range : -40°C / 45°C



KÜP BAHÇE ARMATÜRÜ

Dış mekanlar için IP54 dekoratif bahçe armatürü, dekoratif kübik vurgusu ile ideal aydınlatma çözümleri sunar.

KÜP BAHÇE ARMATÜRÜ (KAFESLİ)

IP54 dekoratif bahçe armatürü için dış alanlar, dekoratif kübik vurgusu ile ideal aydınlatma çözümleri sunar.



KÜP BAHÇE ARMATÜRÜ (1XE27 DUY) CUBE GARDEN ARMATURE

Ürün Kodu Product Code	Renk Color	Boyutlar (WxLxH) mm Dimensions	Gövde Body	Koli Adeti Quantity in Carton	Fiyat Price
BR-BA008	Siyah	220 X 220 X 270	ABS	1	\$17,8

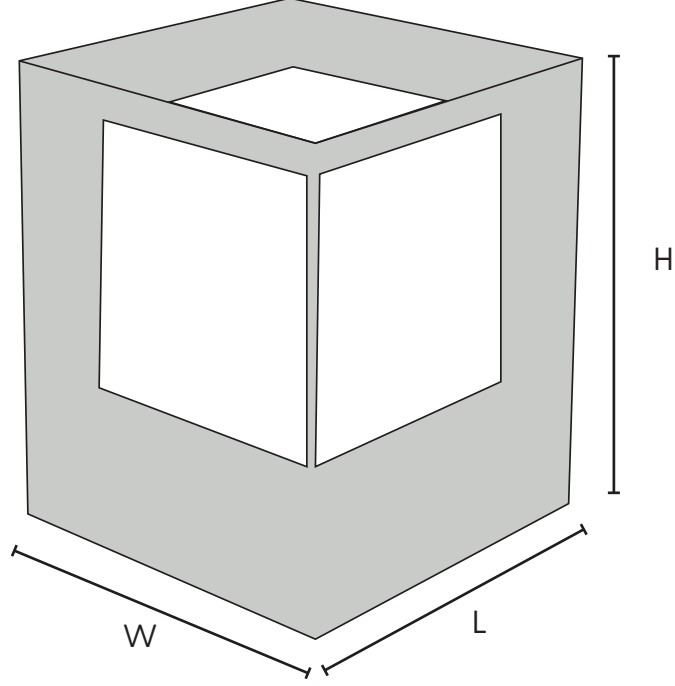

KÜP BAHÇE ARMATÜRÜ (KAFESLİ) - (1XE27 DUY) CUBE GARDEN ARMATURE (CAGED)

Ürün Kodu Product Code	Renk Color	Boyutlar (WxLxH) mm Dimensions	Gövde Body	Koli Adeti Quantity in Carton	Fiyat Price
BR-BA009	Siyah	220 X 220 X 270	ABS	1	\$18,0

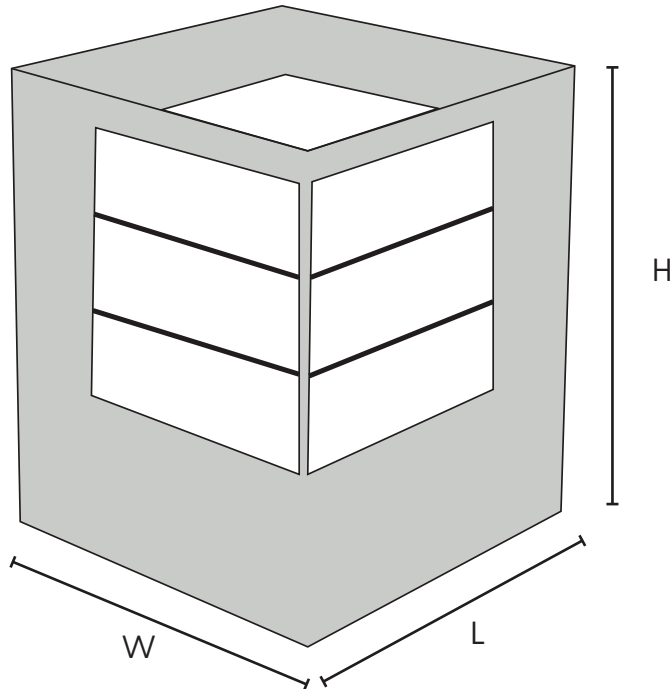

SOLAR SOKAK AYDINLATMA ARMATÜRÜ

SOLAR STREET LIGHTING ARMATURE

Teknik Özellikler

Technical Specifications

Gövde : ABS
Body : ABS

Cam : Polikarbonat Cam
Glass : Polycarbonate Glass

Renksel Geri Verim : 70
Color Rendering Index : 70

IP Derecesi : IP65
IP Rating : IP65

IK Derecesi : IK07
IK Rating : IK07

Elektriksel Koruma : Sınıf III
Electrical Protection : Class III

Kumanda Algılama Mesafesi: 25 m
Remote Control Detecting Distance: 25 m



LED

3
YIL
GARANTİ

50.000
SAAT

IP65



SOLAR SOKAK AYDINLATMA ARMATÜRÜ

Alüminyum alaşımlı şık tasarım. Yeni ısı dağıtım ve işleme teknolojisi ile gün boyunca elektrik enerjisi depolar. Su geçirmez (IP65) oksidasyon önleyici özellikleri ile korozyona ve dış etkenlere dayanıklıdır.

SOLAR STREET LIGHTING ARMATURE

Stylish design with aluminium alloy. It stores electrical energy throughout the day with its new heat distribution and processing technology. It is resistant to corrosion and external factors with its waterproof (IP65) anti-oxidation properties.



SOLAR SOKAK AYDINLATMA ARMATÜRÜ

SOLAR STREET LIGHTING ARMATURE

Ürün Kodu Product Code	Güç (W) Power	Batarya Kapasitesi (mAh) Battery Capacity	Renk Sıcaklığı (K) Color Temperature	Işık Akısı (Lm) Luminous Flux	Boyutlar (WxLxH) mm Dimensions	Renk Color	Koli Adeti Quantity in Carton	Fiyat Price
BL-SP-0010	80W	12000	3000 K	1150	240 × 725 × 45	Siyah	10	\$94,7
BL-SP-0011	80W	12000	4000 K	1150	240 × 725 × 45	Siyah	10	\$94,7
BL-SP-0012	80W	12000	6500 K	1150	240 × 725 × 45	Siyah	10	\$94,7
BL-SP-0013	100W	15000	3000 K	1450	240 × 820 × 60	Siyah	5	\$120,4
BL-SP-0014	100W	15000	4000 K	1450	240 × 820 × 60	Siyah	5	\$120,4
BL-SP-0015	100W	15000	6500 K	1450	240 × 820 × 60	Siyah	5	\$120,4

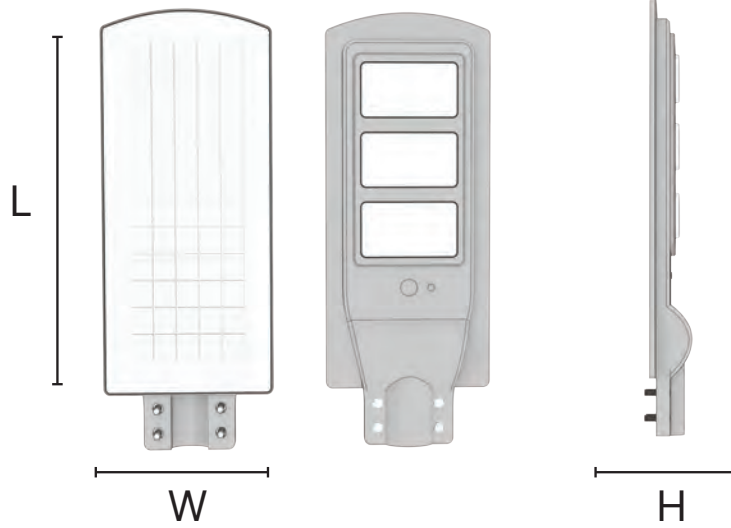

LED RAY SPOT

LED RAIL SPOT

Teknik Özellikler Technical Specifications

Gövde : Alüminyum
Body : Aluminium

Cam : Akrilik
Glass : Acrylic

Renksel Geri Verim : 80
Color Rendering Index : 80

IP Derecesi : IP20
IP Rating : IP20

IK Derecesi : IK03
IK Rating : IK03

Elektriksel Koruma : Sınıf I
Electrical Protection : Class I



LED

2
YIL
GARANTİ

50.000
SAAT

LED RAY SPOT

LED Ray Spotlar; başta mağaza, müze, sahne, kafe, restoran, ofis vb. birçok yerde kullanılan aydınlatma armatürleridir. Tavana veya duvara monte edilmiş ray aparatı üzerinde hareket edebilir ve kendi ekseninde 360° yön değiştirerek vitrin, raf, stand ve reyon gibi belirli bölgeleri aydınlatarak dikkat çekerler.

LED Ray Spotlar, düşük enerji tüketerek yüksek ışık gücü sağlarken, uzun kullanım ömrüne ve estetik bir görünüme sahiptir.

LED RAIL SPOT

LED Rail Spots; mainly for the shop, museum, stage, cafe, restaurant, office etc. They are lighting fixtures used in many places. They can move on the ceiling or wall-mounted rail apparatus and change direction 360° on their axis, attracting attention by illuminating certain areas such as showcases, shelves, stands and sections.

LED Rail Spots provide high light power by consuming low energy and have a long service life and aesthetic appearance.



LED RAY SPOT MONOFAZE

LED RAIL SPOT MONOPHASE

Enerji Verimliliği Sınıfı Energy Efficiency Class	Ürün Kodu Product Code	Güç (W) Power	Renk Sıcaklığı (K) Color Temperature	Işık Akısı (Lm) Luminous Flux	Boyutlar (Ø) mm Dimensions	Renk Color	Koli Adeti Quantity in Carton	Fiyat Price
A++ E	BL-RS-0001	40W	3000 K	4000	115	Siyah-Black	24	\$81,40
A++ E	BL-RS-0002	40W	4000 K	4000	115	Siyah-Black	24	\$81,40
A++ E	BL-RS-0003	40W	6500 K	4000	115	Siyah-Black	24	\$81,40
A++ E	BL-RS-1001	40W	3000 K	4000	115	Beyaz-White	24	\$81,40
A++ E	BL-RS-1002	40W	4000 K	4000	115	Beyaz-White	24	\$81,40
A++ E	BL-RS-1003	40W	6500 K	4000	115	Beyaz-White	24	\$81,40
A++ E	BL-RS-1004	20W	3000 K	2000	115	Siyah-Black	24	\$81,40
A++ E	BL-RS-1005	20W	4000 K	2000	115	Siyah-Black	24	\$81,40
A++ E	BL-RS-1006	20W	6500 K	2000	115	Siyah-Black	24	\$81,40
A++ E	BL-RS-1007	20W	3000 K	2000	115	Beyaz-White	24	\$81,40
A++ E	BL-RS-1008	20W	4000 K	2000	115	Beyaz-White	24	\$81,40
A++ E	BL-RS-1009	20W	6500 K	2000	115	Beyaz-White	24	\$81,40

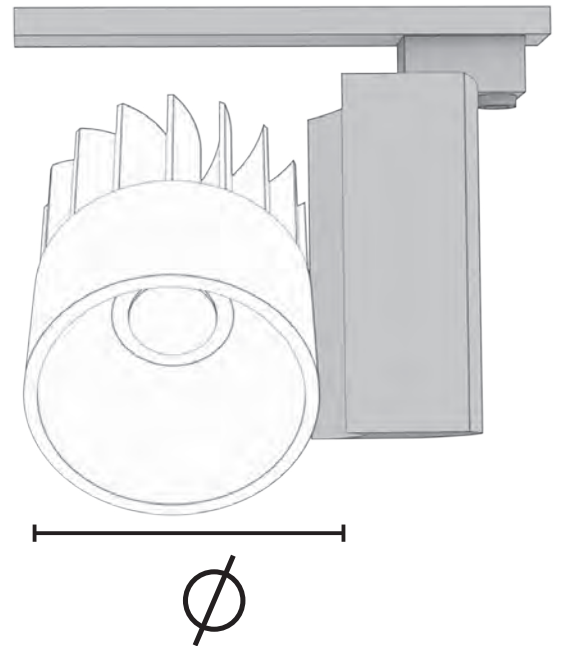
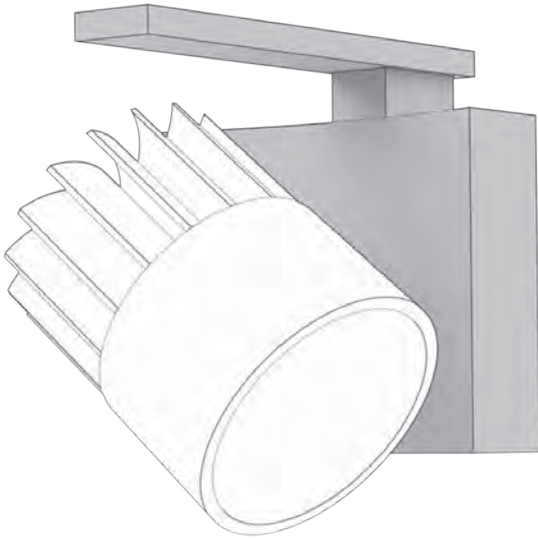

LED RAY SPOT APARATLARI

LED RAIL SPOT

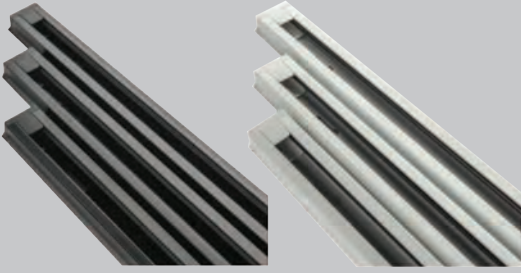

MONOFAZE RAY
MONOPHASE RAIL



MONOFAZE SOKET
MONOPHASE SOCKET



EK PARÇA
ATTACHMENT



ASKI APARATI
HANGER APPARATUS

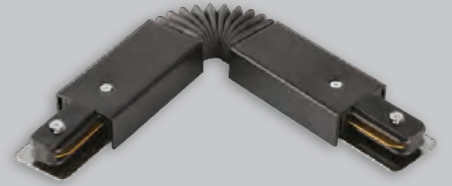

SPIRAL DÖNÜŞ
SPIRAL TURN



ENERJİ GİRİŞİ
ENERGY INPUT

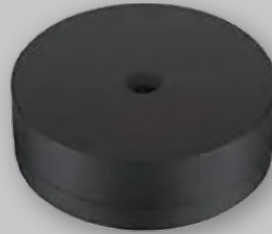

SOKETLİ ROZANS
SOCKET ROZANCE



T APARAT
T PIECE

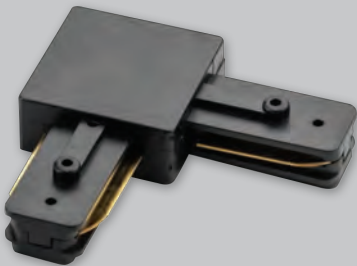

L APARAT
L PIECE

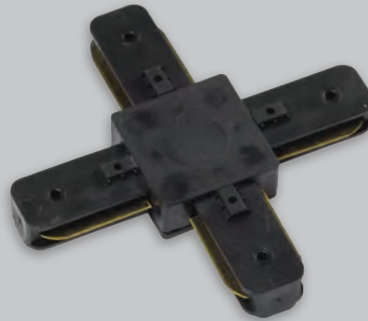

ARTI BAĞLANTI
PLUS CONNECTION

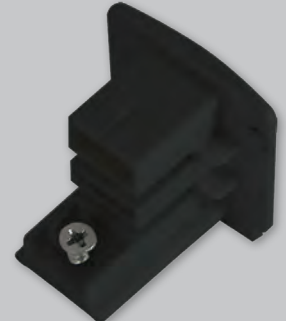

SONLAMA
ENDING

LED RAY SPOT APARATLARI

Raylı led spot aydınlatmalar ile birlikte kullanılan çeşitli aksesuarlar bulunur. Ray, ara bağlantı aparatı, soket, T dönüş, L dönüş, köşe dönüş, askı aparatı, sonlandırma kapağı, artı dönüş, enerji girişi, ray soketi vb ek parça ürünlerdir.

LED RAIL SPOT

There are various accessories used with rail led spotlights. Rail, interconnection apparatus, socket, T turn, L turn, corner turn, suspension apparatus, termination cover, plus turn, energy input, rail socket etc. are additional part products.

MONOFAZE RAY MONOPHASE RAIL

Ürün Kodu Product Code	Boyutlar (Metre) Dimensions	Renk Color	Koli Adeti Quantity in Carton	Fiyat Price
BR-RSA-0001	1	Beyaz-White	20	\$11,3
BR-RSA-0002	2	Beyaz-White	20	\$22,7
BR-RSA-0003	3	Beyaz-White	20	\$34,0
BR-RSA-0004	1	Siyah-Black	20	\$11,3
BR-RSA-0005	2	Siyah-Black	20	\$22,7
BR-RSA-0006	3	Siyah-Black	20	\$34,0

L APARAT L PIECE

Ürün Kodu Product Code	Renk Color	Koli Adeti Quantity in Carton	Fiyat Price
BR-RSA-0009	Siyah-Black	100	\$2,90
BR-RSA-0012	Beyaz-White	100	\$9,60

T APARAT T PIECE

Ürün Kodu Product Code	Renk Color	Koli Adeti Quantity in Carton	Fiyat Price
BR-RSA-0014	Siyah-Black	200	\$19,8
BR-RSA-0022	Beyaz-White	200	\$19,8

SPİRAL DÖNÜŞ L PIECE

Ürün Kodu Product Code	Renk Color	Koli Adeti Quantity in Carton	Fiyat Price
BR-RSA-0016	Siyah-Black	200	\$31,5
BR-RSA-0024	Beyaz-White	200	\$31,5

SONLAMA ENDING

Ürün Kodu Product Code	Renk Color	Koli Adeti Quantity in Carton	Fiyat Price
BR-RSA-0018	Siyah-Black	200	\$2,1
BR-RSA-0026	Beyaz-White	200	\$2,1

SOKETLİ ROZANS SOCKET ROZANCE

Ürün Kodu Product Code	Renk Color	Koli Adeti Quantity in Carton	Fiyat Price
BR-RSA-0020	Siyah-Black	200	\$7,6
BR-RSA-0028	Beyaz-White	200	\$7,6

MONOFAZE SOKET MONOPHASE SOCKET

Ürün Kodu Product Code	Renk Color	Koli Adeti Quantity in Carton	Fiyat Price
BR-RSA-0007	Siyah-Black	200	\$4,00
BR-RSA-0010	Beyaz-White	200	\$9,60

EK PARÇA ATTACHMENT

Ürün Kodu Product Code	Renk Color	Koli Adeti Quantity in Carton	Fiyat Price
BR-RSA-0008	Siyah-Black	100	\$2,0
BR-RSA-0011	Beyaz-White	100	\$2,0

KABLOLU SOKET WIRED SOCKET

Ürün Kodu Product Code	Renk Color	Koli Adeti Quantity in Carton	Fiyat Price
BR-RSA-0013	Siyah-Black	200	\$4,0
BR-RSA-0021	Beyaz-White	200	\$4,0

ARTI BAĞLANTI PLUS CONNECTION

Ürün Kodu Product Code	Renk Color	Koli Adeti Quantity in Carton	Fiyat Price
BR-RSA-0015	Siyah-Black	200	\$25,6
BR-RSA-0023	Beyaz-White	200	\$25,6

ENERJİ GİRİŞİ ENERGY INPUT

Ürün Kodu Product Code	Renk Color	Koli Adeti Quantity in Carton	Fiyat Price
BR-RSA-0017	Siyah-Black	200	\$8,2
BR-RSA-0025	Beyaz-White	200	\$8,2

ASKI APARATI HANGER APPARATUS

Ürün Kodu Product Code	Renk Color	Koli Adeti Quantity in Carton	Fiyat Price
BR-RSA-0019	Siyah-Black	200	\$10,3
BR-RSA-0027	Beyaz-White	200	\$10,3



LED YÜKSEK TAVAN ARMATÜR

LED HIGH CEILING ARMATURE

Teknik Özellikler

Technical Specifications

Gövde : Alüminyum
Body : Aluminium

Difüzör : Polikarbon Cam
Diffuser : Polycarbon Glass

Renksel Geri Verim : 80
Color Rendering Index : 80

Sürücü : Philips
Driver : Philips

IP Derecesi : IP54
IP Rating : IP54

IK Derecesi : IK03
IK Rating : IK03

Elektriksel Koruma : Sınıf I
Electrical Protection : Class I

Çalışma Sıcaklığı : -20°C / 45°C
Operating Temp. Range : -20°C / 45°C



LED

3 YIL GARANTİ

50.000 SAAT

IP54

LED YÜKSEK TAVAN ARMATÜR

Yüksek tavanlı, erişimi ve bakımı zor olan endüstriyel ve ticari alanları aydınlatmaya yönelik, uzun ömürlü, yüksek enerji tasarrufu ve optimum performans sunar. Estetik, dayanıklılık ve maliyet avantajları sağlar.

LED HIGH CEILING ARMATURE

It offers long-lasting, high energy saving and optimum performance for illuminating industrial and commercial areas with high ceilings, which are difficult to access and maintain. It provides aesthetic, durability and cost advantages.



LED YÜKSEK TAVAN ARMATÜR

LED HIGH CEILING ARMATURE

Enerji Verimliliği Sınıfı Energy Efficiency Class	Ürün Kodu Product Code	Güç (W) Power	Renk Sıcaklığı (K) Color Temperature	Işık Akısı (Lm) Luminous Flux	Boyutlar (WxLxH) mm Dimensions	Opsiyonlar Options	Koli Adeti Quantity in Carton	Fiyat Price
A++ E	BL-Y1-0001	55W	3000 K	6600	132×600×75	-	1	\$108,9
A++ E	BL-Y1-0001-3H	55W	3000 K	6600	132×600×75	3 Saat Acil Kit	1	\$158,4
A++ E	BL-Y1-0002	55W	4000 K	6600	132×600×75	-	1	\$108,9
A++ E	BL-Y1-0002-3H	55W	4000 K	6600	132×600×75	3 Saat Acil Kit	1	\$158,4
A++ E	BL-Y1-0003	55W	6500 K	6600	132×600×75	-	1	\$108,9
A++ E	BL-Y1-0003-3H	55W	6500 K	6600	132×600×75	3 Saat Acil Kit	1	\$158,4
A++ E	BL-Y1-0004	90W	3000 K	10800	132×1000×75	-	1	\$217,8
A++ E	BL-Y1-0004-3H	90W	3000 K	10800	132×1000×75	3 Saat Acil Kit	1	\$263,5
A++ E	BL-Y1-0005	90W	4000 K	10800	132×1000×75	-	1	\$217,8
A++ E	BL-Y1-0005-3H	90W	4000 K	10800	132×1000×75	3 Saat Acil Kit	1	\$263,5
A++ E	BL-Y1-0006	90W	6500 K	10800	132×1000×75	-	1	\$217,8
A++ E	BL-Y1-0006-3H	90W	6500 K	10800	132×1000×75	3 Saat Acil Kit	1	\$263,5
A++ E	BL-Y1-0007	110W	3000 K	13200	132×1200×75	-	1	\$230,0
A++ E	BL-Y1-0007-3H	110W	3000 K	13200	132×1200×75	3 Saat Acil Kit	1	\$276,3
A++ E	BL-Y1-0008	110W	4000 K	13200	132×1200×75	-	1	\$230,0
A++ E	BL-Y1-0008-3H	110W	4000 K	13200	132×1200×75	3 Saat Acil Kit	1	\$276,3
A++ E	BL-Y1-0009	110W	6500 K	13200	132×1200×75	-	1	\$230,0
A++ E	BL-Y1-0009-3H	110W	6500 K	13200	132×1200×75	3 Saat Acil Kit	1	\$276,3
A++ E	BL-Y1-0010	135W	3000 K	16200	132×1500×75	-	1	\$279,9
A++ E	BL-Y1-0010-3H	135W	3000 K	16200	132×1500×75	3 Saat Acil Kit	1	\$284,8
A++ E	BL-Y1-0011	135W	4000 K	16200	132×1500×75	-	1	\$279,9
A++ E	BL-Y1-0011-3H	135W	4000 K	16200	132×1500×75	3 Saat Acil Kit	1	\$284,8
A++ E	BL-Y1-0012	135W	6500 K	16200	132×1500×75	-	1	\$279,9
A++ E	BL-Y1-0012-3H	135W	6500 K	16200	132×1500×75	3 Saat Acil Kit	1	\$284,8

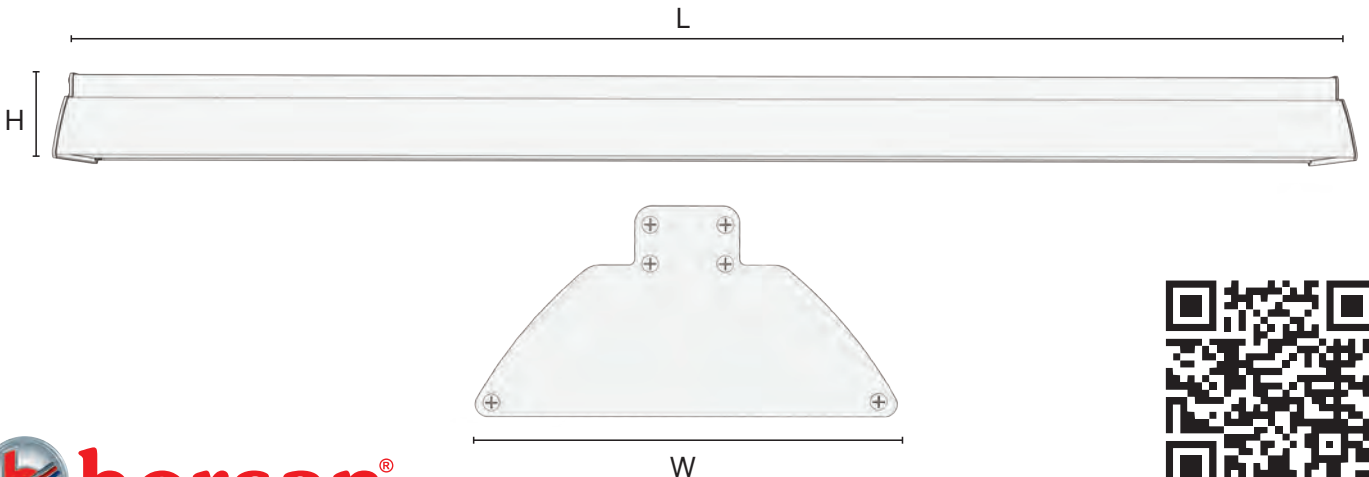

LED LINEER ARMATÜR

LED LINEAR ARMATURE

Teknik Özellikler

Technical Specifications

Gövde : Alüminyum
Body : Aluminium

Difüzör : Polikarbon Cam
Diffuser : Polycarbon Glass

Renksel Geri Verim : 80
Color Rendering Index : 80

IP Derecesi : IP54
IP Rating : IP54

IK Derecesi : IK03
IK Rating : IK03

Elektriksel Koruma : Sınıf I
Electrical Protection : Class I

Çalışma Sıcaklığı : -20°C / 45°C
Operating Temp. Range : -20°C / 45°C

Sıva Üstü Üründe 1m Askı Teli
1m Hanger Wire for Surface Mounted Product

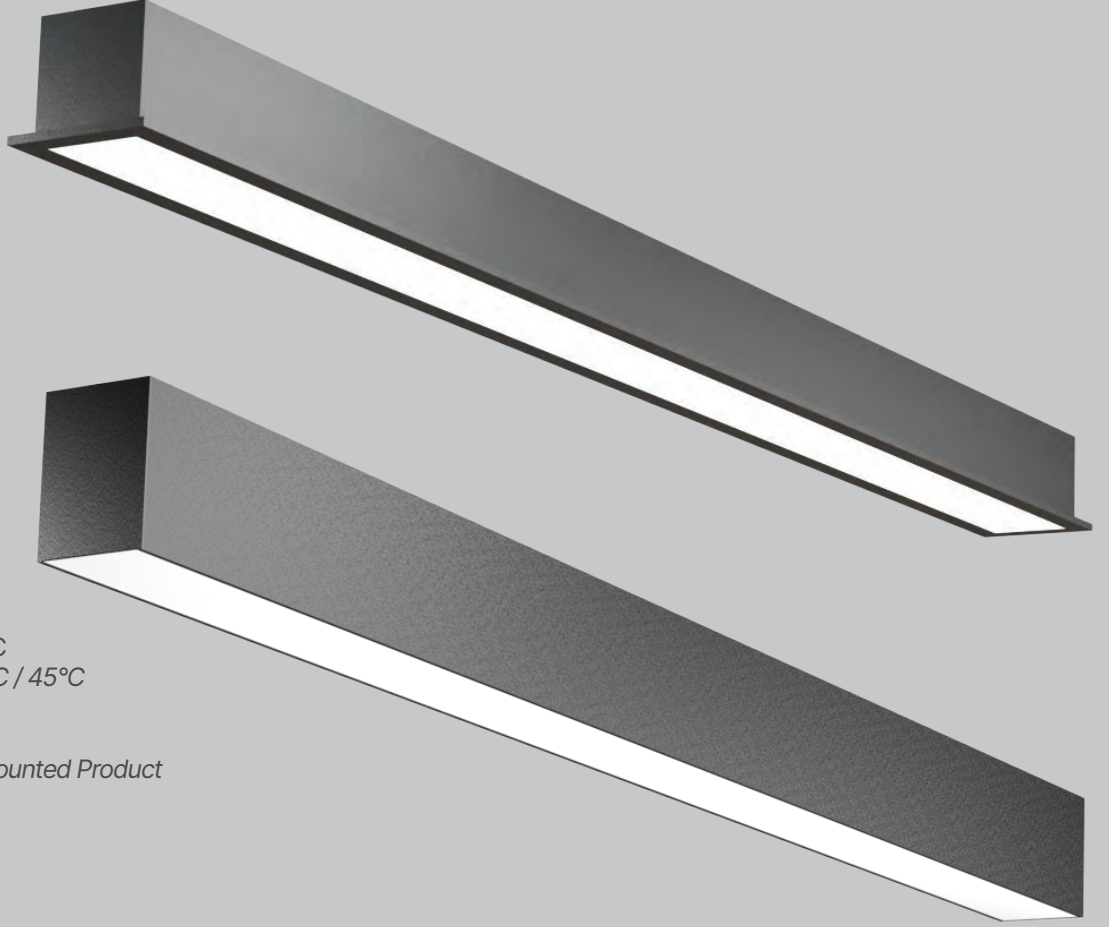

LED

3 YIL GARANTİ

50.000 SAAT

IP54

LED LINEER ARMATÜR

Led lineer armatürler, aydınlatmada üst seviye ışıklandırma, dekoratif ortam ve sağlıklı çalışma performansı sağlamaktadır.

Yüksek kaliteli alüminyum gövde, renk ve boyut alternatifleri sunar.

Led Lineer armatürler, düşük enerji kullanımı ve uzun ömürlü olması nedeniyle son derece verimli çalışır.

Sıva altında, sıva üstünde veya sarkıt aksesuarlar ile rahatlıkla kullanılabilir.

LED LINEAR ARMATURE

Led linear luminaires provide high level lighting, decorative environment and healthy working performance in lighting.

It offers high quality Aluminium body, color and size alternatives.

Led Linear luminaires will be extremely efficient due to low energy use and being in use.

It can be used under plaster, on surface or with pendant accessories.



LED LINEER SIVA ALTI ARMATÜR

LED LINEAR FLUSH MOUNTED ARMATURE

Enerji Verimliliği Sınıfı Energy Efficiency Class	Ürün Kodu Product Code	Güç (W) Power	Renk Sıcaklığı (K) Color Temperature	Işık Akısı (Lm) Luminous Flux	Boyutlar (WxLxH) mm Dimensions	Koli Adeti Quantity in Carton	Fiyat Price
A+ E	BL-L1-1001	15W	4000 K	1800	66 × 650 × 90	1	\$112,9
A+ E	BL-L1-1002	15W	6500 K	1800	66 × 650 × 90	1	\$112,9
A+ E	BL-L1-1003	20W	4000 K	2400	66 × 650 × 90	1	\$115,1
A+ E	BL-L1-1004	20W	6500 K	2400	66 × 650 × 90	1	\$115,1
A+ E	BL-L1-1005	30W	4000 K	3600	66 × 1250 × 90	1	\$190,8
A+ E	BL-L1-1006	30W	6500 K	3600	66 × 1250 × 90	1	\$190,8
A+ E	BL-L1-1007	40W	4000 K	4800	66 × 1250 × 90	1	\$194,5
A+ E	BL-L1-1008	40W	6500 K	4800	66 × 1250 × 90	1	\$194,5
A+ E	BL-L1-1009	45W	4000 K	5400	66 × 1550 × 90	1	\$233,7
A+ E	BL-L1-1010	45W	6500 K	5400	66 × 1550 × 90	1	\$233,7
A+ E	BL-L1-1011	50W	4000 K	6000	66 × 1550 × 90	1	\$239,9
A+ E	BL-L1-1012	50W	6500 K	6000	66 × 1550 × 90	1	\$239,9

LED LINEER SIVA ÜSTÜ ARMATÜR

LED LINEAR SURFACE MOUNTED ARMATURE

Enerji Verimliliği Sınıfı Energy Efficiency Class	Ürün Kodu Product Code	Güç (W) Power	Renk Sıcaklığı (K) Color Temperature	Işık Akısı (Lm) Luminous Flux	Boyutlar (WxLxH) mm Dimensions	Koli Adeti Quantity in Carton	Fiyat Price
A+ E	BL-L1-2001	15W	4000 K	1800	66 × 600 × 90	1	\$100,9
A+ E	BL-L1-2002	15W	6500 K	1800	66 × 600 × 90	1	\$100,9
A+ E	BL-L1-2003	20W	4000 K	2400	66 × 600 × 90	1	\$104,6
A+ E	BL-L1-2004	20W	6500 K	2400	66 × 600 × 90	1	\$104,6
A+ E	BL-L1-2005	30W	4000 K	3600	66 × 1200 × 90	1	\$162,3
A+ E	BL-L1-2006	30W	6500 K	3600	66 × 1200 × 90	1	\$162,3
A+ E	BL-L1-2007	40W	4000 K	4800	66 × 1200 × 90	1	\$166,0
A+ E	BL-L1-2008	40W	6500 K	4800	66 × 1200 × 90	1	\$166,0
A+ E	BL-L1-2009	45W	4000 K	5400	66 × 1500 × 90	1	\$194,7
A+ E	BL-L1-2010	45W	6500 K	5400	66 × 1500 × 90	1	\$194,7
A+ E	BL-L1-2011	50W	4000 K	6000	66 × 1500 × 90	1	\$203,0
A+ E	BL-L1-2012	50W	6500 K	6000	66 × 1500 × 90	1	\$203,0

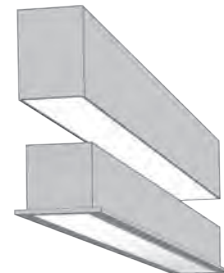

LENSLİ LINEER ARMATÜR

LINEAR ARMATURE WITH LENS

Teknik Özellikler

Technical Specifications

Gövde : Alüminyum
Body : Aluminium

Difüzör : Polikarbon Cam
Diffuser : Polycarbon Glass

Renksel Geri Verim : 80
Color Rendering Index : 80

IP Derecesi : IP54
IP Rating : IP54

IK Derecesi : IK03
IK Rating : IK03

Elektriksel Koruma : Sınıf I
Electrical Protection : Class I

Çalışma Sıcaklığı : -20°C / 45°C
Operating Temp. Range : -20°C / 45°C

Sıva Üstü Üründe 1m Askı Teli
1m Hanger Wire for Surface Mounted
Product

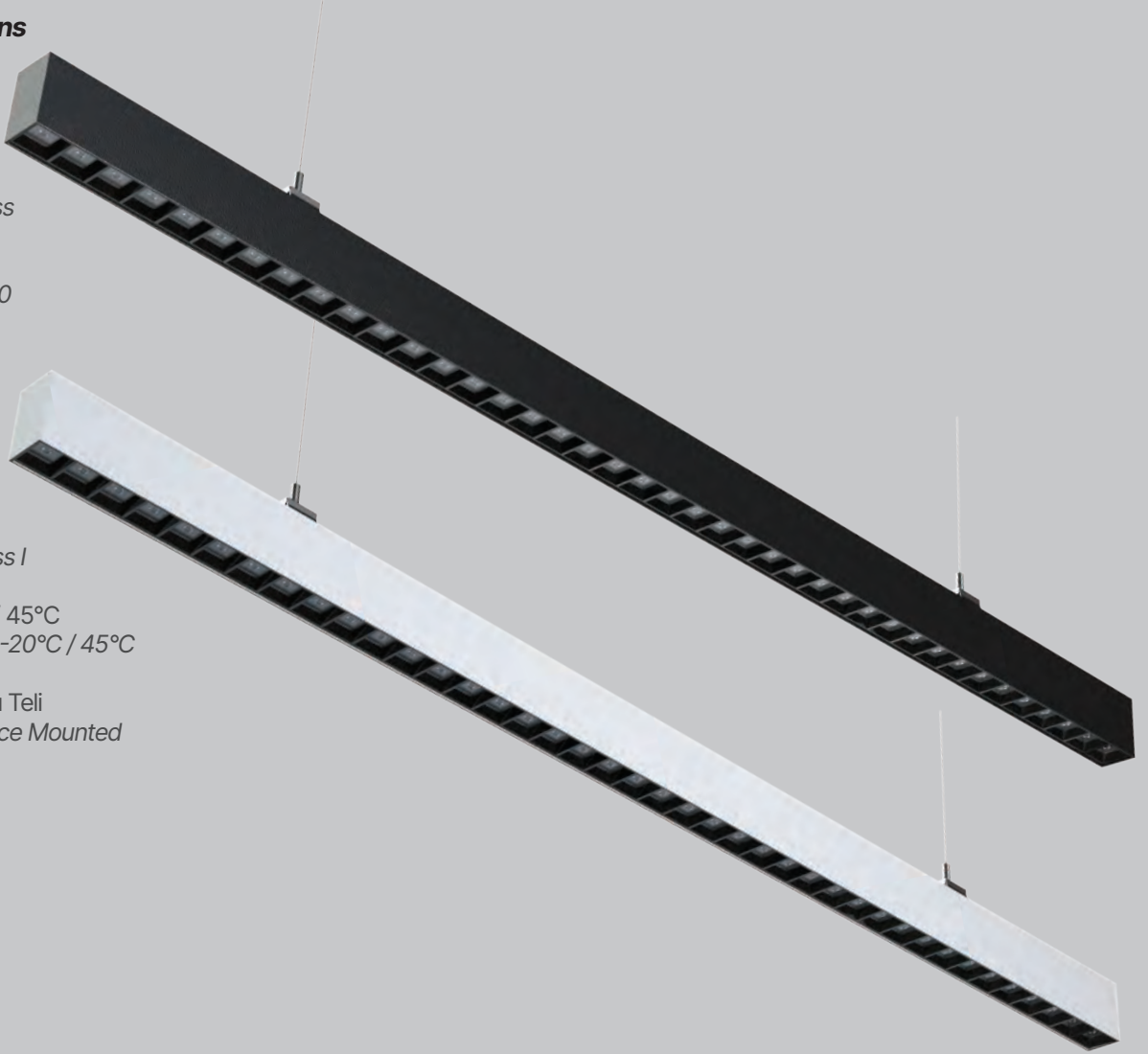

LED

3
YIL
GARANTİ

50.000
SAAT

IP54

LENSLİ LINEER ARMATÜR

Led lineer armatürler, aydınlatmada üst seviye ışıklandırma, dekoratif ortam ve sağlıklı çalışma performansı sağlamaktadır.

Yüksek kaliteli alüminyum gövde, renk ve boyut alternatifleri sunar.

Led Lineer armatürler, düşük enerji kullanımı ve uzun ömürlü olması nedeniyle son derece verimli çalışır.

Sıva altında, sıva üstünde veya sarkıt aksesuarlar ile rahatlıkla kullanılabilir.

LINEAR ARMATURE WITH LENS

Led linear luminaires provide high level lighting, decorative environment and healthy working performance in lighting.

It offers high quality Aluminium body, color and size alternatives.

Led Linear luminaires will be extremely efficient due to low energy use and being in use.

It can be used under plaster, on surface or with pendant accessories.



LENSLİ LED LINEER SIVA ALTI ARMATÜR

LED LINEAR FLUSH MOUNTED ARMATURE WITH LENS

Enerji Verimliliği Sınıfı Energy Efficiency Class	Ürün Kodu Product Code	Güç (W) Power	Renk Sıcaklığı (K) Color Temperature	Işık Akısı (Lm) Luminous Flux	Boyutlar (WxLxH) mm Dimensions	Renk Color	Koli Adeti Quantity in Carton	Fiyat Price
A T G	BL-L2-1001	25W	4000 K	1750	Siyah	35 × 670 × 70	1	\$53,25
A T G	BL-L2-1002	25W	6500 K	1750	Siyah	35 × 670 × 70	1	\$53,25
A T G	BL-L2-1003	40W	4000 K	2800	Siyah	35 × 1070 × 70	1	\$85,30
A T G	BL-L2-1004	40W	6500 K	2800	Siyah	35 × 1070 × 70	1	\$85,30
A T G	BL-L2-1011	25W	4000 K	1750	Beyaz	35 × 670 × 70	1	\$53,25
A T G	BL-L2-1012	25W	6500 K	1750	Beyaz	35 × 670 × 70	1	\$53,25
A T G	BL-L2-1013	40W	4000 K	2800	Beyaz	35 × 1070 × 70	1	\$85,30
A T G	BL-L2-1014	40W	6500 K	2800	Beyaz	35 × 1070 × 70	1	\$85,30

LENSLİ LED LINEER SIVA ÜSTÜ ARMATÜR

LED LINEAR SURFACE MOUNTED ARMATURE WITH LENS

Enerji Verimliliği Sınıfı Energy Efficiency Class	Ürün Kodu Product Code	Güç (W) Power	Renk Sıcaklığı (K) Color Temperature	Işık Akısı (Lm) Luminous Flux	Boyutlar (WxLxH) mm Dimensions	Renk Color	Koli Adeti Quantity in Carton	Fiyat Price
A T G	BL-L2-2001	25W	4000 K	1750	Siyah	35 × 670 × 70	1	\$61,1
A T G	BL-L2-2002	25W	6500 K	1750	Siyah	35 × 670 × 70	1	\$61,1
A T G	BL-L2-2003	40W	4000 K	2800	Siyah	35 × 1070 × 70	1	\$100,1
A T G	BL-L2-2004	40W	6500 K	2800	Siyah	35 × 1070 × 70	1	\$100,1
A T G	BL-L2-2011	25W	4000 K	1750	Beyaz	35 × 670 × 70	1	\$61,1
A T G	BL-L2-2012	25W	6500 K	1750	Beyaz	35 × 670 × 70	1	\$61,1
A T G	BL-L2-2013	40W	4000 K	2800	Beyaz	35 × 1070 × 70	1	\$100,1
A T G	BL-L2-2014	40W	6500 K	2800	Beyaz	35 × 1070 × 70	1	\$100,1

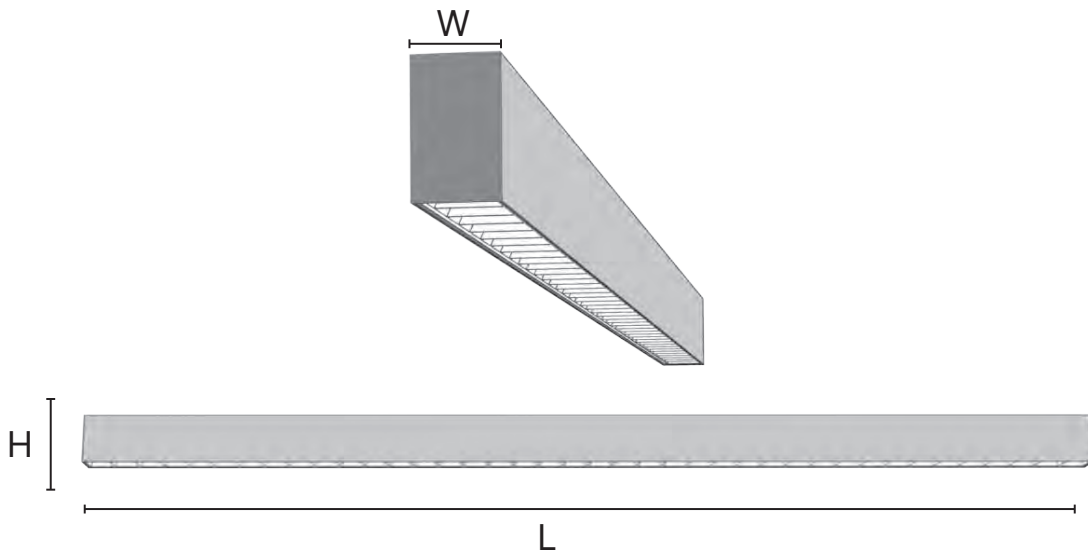

LED LEVEL ETANJ ARMATÜR

LED LEVEL WATERPROOF ARMATURE

Teknik Özellikler

Technical Specifications

Gövde : Polikarbonat
Body : Polycarbonate

Gövde Renkleri : Gri
Body Colors : Grey

Kapak : Polikarbonat
Cover : Polycarbonate

Kapak Rengi : Gri
Cover Color : Grey

Renksel Geri Verim : 80
Color Rendering Index : 80

IP Derecesi : IP65
IP Rating : IP65

IK Derecesi : IK09
IK Rating : IK09

Elektriksel Koruma : Sınıf II
Electrical Protection : Class II

Çalışma Sıcaklığı : -20°C / 45°C
Operating Temp. Range : -20°C / 45°C

3000 K OPSİYONDUR
L : 1500 MM OPSİYONU VARDIR

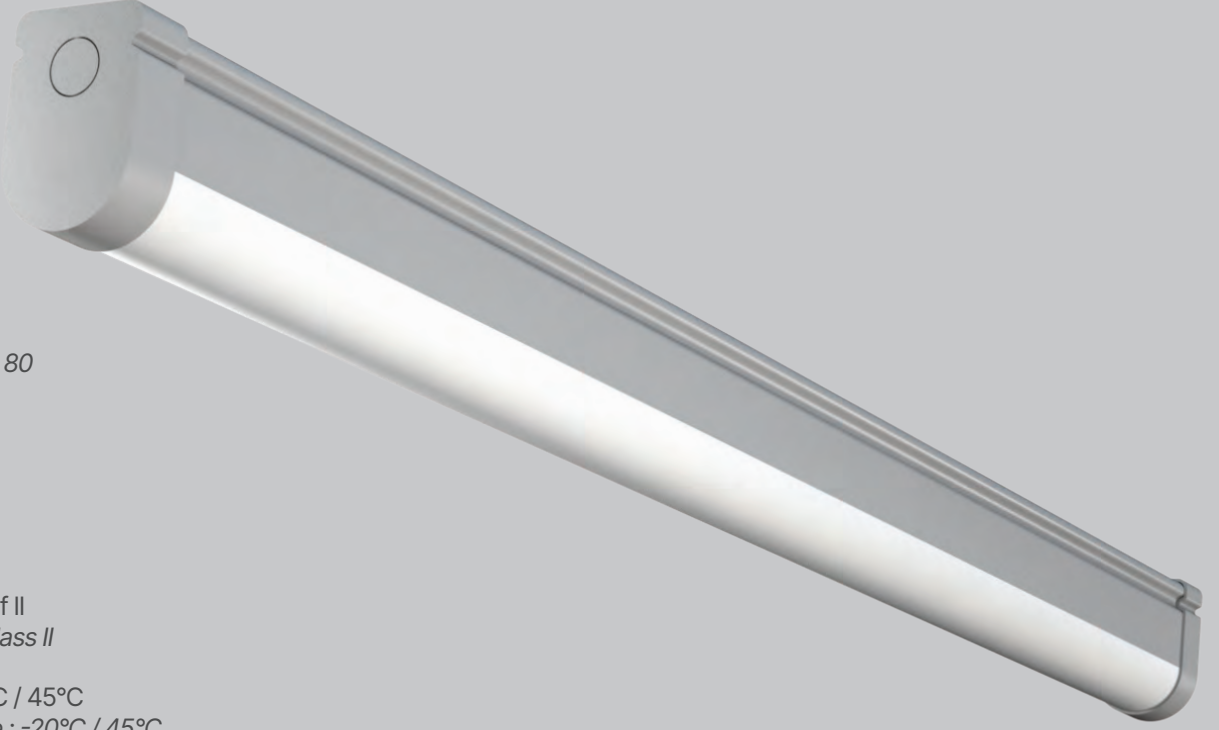

LED

3
YIL
GARANTİ

50.000
SAAT

IP65



LED LEVEL ETANJ ARMATÜR

IP65 koruma standartlarında polikarbon gövde ve difüzör yapısı; neme, toza, doğrudan su ve darbelere karşı etkindir. Led aydınlatma ve difüzör tasarımı, her türlü alanda yüksek ışık verimliliği ve konforlu görüş sağlar. Kolay montaj ve bakım imkanları sunar.











LED LEVEL WATERPROOF ARMATURE

Polycarbonate body and diffuser structure in IP65 protection standards; It is effective against moisture, dust, direct water and impacts. Led lighting and diffuser design provide high luminous efficiency and comfortable vision in all kinds of areas. It offers easy installation and maintenance opportunities.



LED LEVEL ETANJ ARMATÜR

LED LEVEL WATERPROOF ARMATURE

Enerji Verimliliği Sınıfı Energy Efficiency Class	Ürün Kodu Product Code	Güç (W) Power	Renk Sıcaklığı (K) Color Temperature	Işık Akısı (Lm) Luminous Flux	Boyutlar (WxLxH) mm Dimensions	Opsiyonlar Options	Koli Adeti Quantity in Carton	Fiyat Price
	BL-E1-0009	15W	4000 K	1350	44 × 600 × 64	-	12	\$18,9
	BL-E1-0009-1H	15W	4000 K	1350	44 × 600 × 64	1 Saat Acil Kit	12	\$75,8
	BL-E1-0009-3H	15W	4000 K	1350	44 × 600 × 64	3 Saat Acil Kit	12	\$89,6
	BL-E1-0009-RS	15W	4000 K	1350	44 × 600 × 64	Radar Sensörlü	12	\$29,1
	BL-E1-0009-RS-1H	15W	4000 K	1350	44 × 600 × 64	Radar Sensörlü 1 Saat Acil Kit	12	\$78,8
	BL-E1-0009-RS-3H	15W	4000 K	1350	44 × 600 × 64	Radar Sensörlü 3 Saat Acil Kit	12	\$92,6
	BL-E1-0013	15W	6500 K	1350	44 × 600 × 64	-	12	\$18,9
	BL-E1-0013-1H	15W	6500 K	1350	44 × 600 × 64	1 Saat Acil Kit	12	\$75,8
	BL-E1-0013-3H	15W	6500 K	1350	44 × 600 × 64	3 Saat Acil Kit	12	\$89,6
	BL-E1-0013-RS	15W	6500 K	1350	44 × 600 × 64	Radar Sensörlü	12	\$29,1
	BL-E1-0013-RS-1H	15W	6500 K	1350	44 × 600 × 64	Radar Sensörlü 1 Saat Acil Kit	12	\$78,8
	BL-E1-0013-RS-3H	15W	6500 K	1350	44 × 600 × 64	Radar Sensörlü 3 Saat Acil Kit	12	\$92,6
	BL-E1-0011	30W	4000 K	2700	44 × 1200 × 64	-	12	\$32,2
	BL-E1-0011-1H	30W	4000 K	2700	44 × 1200 × 64	1 Saat Acil Kit	12	\$86,0
	BL-E1-0011-3H	30W	4000 K	2700	44 × 1200 × 64	3 Saat Acil Kit	12	\$102,7
	BL-E1-0011-RS	30W	4000 K	2700	44 × 1200 × 64	Radar Sensörlü	12	\$61,2
	BL-E1-0011-RS-1H	30W	4000 K	2700	44 × 1200 × 64	Radar Sensörlü 1 Saat Acil Kit	12	\$89,0
	BL-E1-0011-RS-3H	30W	4000 K	2700	44 × 1200 × 64	Radar Sensörlü 3 Saat Acil Kit	12	\$105,7
	BL-E1-0015	30W	6500 K	2700	44 × 1200 × 64	-	12	\$32,2
	BL-E1-0015-1H	30W	6500 K	2700	44 × 1200 × 64	1 Saat Acil Kit	12	\$86,0
	BL-E1-0015-3H	30W	6500 K	2700	44 × 1200 × 64	3 Saat Acil Kit	12	\$102,7
	BL-E1-0015-RS	30W	6500 K	2700	44 × 1200 × 64	Radar Sensörlü	12	\$61,2
	BL-E1-0015-RS-1H	30W	6500 K	2700	44 × 1200 × 64	Radar Sensörlü 1 Saat Acil Kit	12	\$89,0
	BL-E1-0015-RS-3H	30W	6500 K	2700	44 × 1200 × 64	Radar Sensörlü 3 Saat Acil Kit	12	\$105,7



LED LEVEL ETANJ ARMATÜR TSE

LED LEVEL WATERPROOF ARMATURE TSE

Teknik Özellikler

Technical Specifications

Gövde : Polikarbonat
Body : Polycarbonate

Gövde Renkleri : Gri
Body Colors : Grey

Kapak : Polikarbonat
Cover : Polycarbonate

Kapak Rengi : Gri
Cover Color : Grey

Renksel Geri Verim : 80
Color Rendering Index : 80

IP Derecesi : IP65
IP Rating : IP65

IK Derecesi : IK09
IK Rating : IK09

Elektriksel Koruma : Sınıf II
Electrical Protection : Class II

Çalışma Sıcaklığı : -20°C / 45°C
Operating Temp. Range : -20°C / 45°C

3000 K OPSİYONDUR
L : 1500 MM OPSİYONU VARDIR

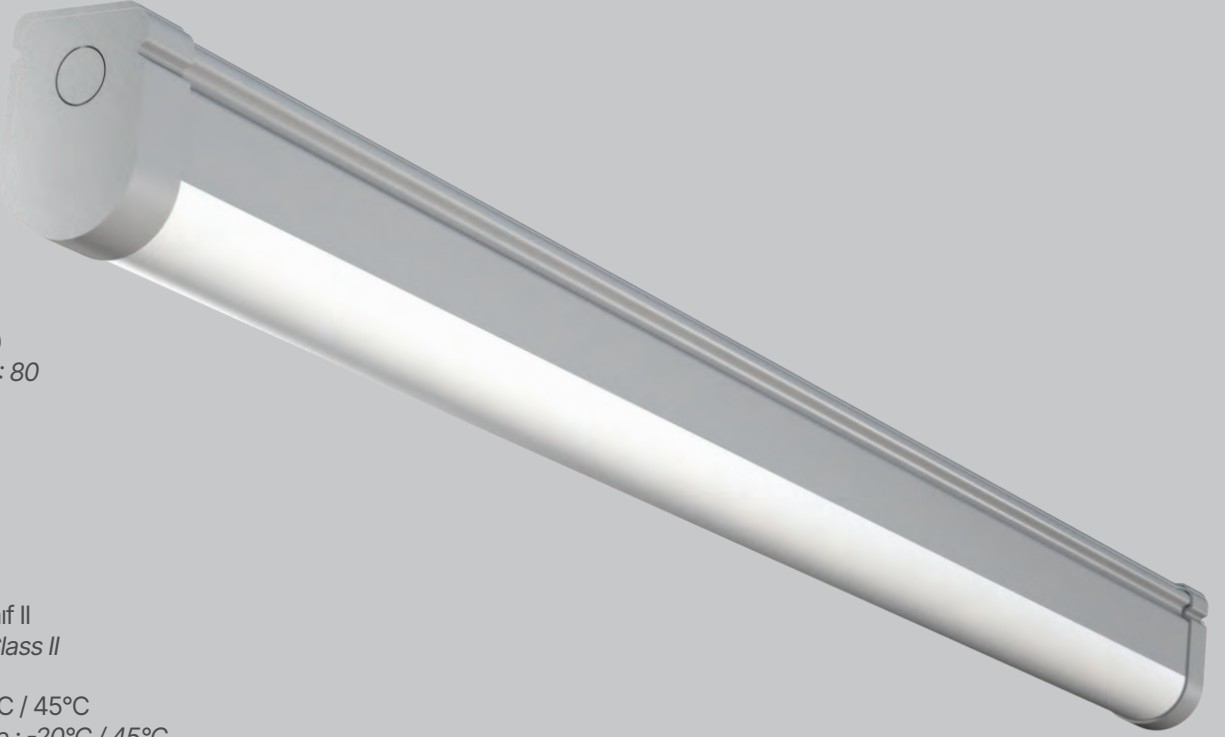

LED

3
YIL
GARANTİ

50.000
SAAT

IP65



LED LEVEL ETANJ ARMATÜR TSE

IP65 koruma standartlarında polikarbon gövde ve difüzör yapısı; neme, toza, doğrudan su ve darbelere karşı etkindir. Led aydınlatma ve difüzör tasarımı, her türlü alanda yüksek ışık verimliliği ve konforlu görüş sağlar. Kolay montaj ve bakım imkanları sunar.

LED LEVEL WATERPROOF ARMATURE TSE

Polycarbonate body and diffuser structure in IP65 protection standards; It is effective against moisture, dust, direct water and impacts. Led lighting and diffuser design provide high luminous efficiency and comfortable vision in all kinds of areas. It offers easy installation and maintenance opportunities.



LED LEVEL ETANJ ARMATÜR TSE

LED LEVEL WATERPROOF ARMATURE TSE

Enerji Verimliliği Sınıfı Energy Efficiency Class	Ürün Kodu Product Code	Güç (W) Power	Renk Sıcaklığı (K) Color Temperature	Işık Akısı (Lm) Luminous Flux	Boyutlar (WxLxH) mm Dimensions	Opsiyonlar Options	Koli Adeti Quantity in Carton	Fiyat Price
	BLT-E1-0009	15W	4000 K	1500	44 × 600 × 64	-	12	\$40,5
	BLT-E1-0009-1H	15W	4000 K	1500	44 × 600 × 64	1 Saat Acil Kit	12	\$98,0
	BLT-E1-0009-3H	15W	4000 K	1500	44 × 600 × 64	3 Saat Acil Kit	12	\$112,9
	BLT-E1-0009-RS	15W	4000 K	1500	44 × 600 × 64	Radar Sensörlü	12	\$73,2
	BLT-E1-0009-RS-1H	15W	4000 K	1500	44 × 600 × 64	Radar Sensörlü 1 Saat Acil Kit	12	\$127,4
	BLT-E1-0009-RS-3H	15W	4000 K	1500	44 × 600 × 64	Radar Sensörlü 3 Saat Acil Kit	12	\$142,3
	BLT-E1-0013	15W	6500 K	1500	44 × 600 × 64	-	12	\$40,5
	BLT-E1-0013-1H	15W	6500 K	1500	44 × 600 × 64	1 Saat Acil Kit	12	\$98,0
	BLT-E1-0013-3H	15W	6500 K	1500	44 × 600 × 64	3 Saat Acil Kit	12	\$112,9
	BLT-E1-0013-RS	15W	6500 K	1500	44 × 600 × 64	Radar Sensörlü	12	\$73,2
	BLT-E1-0013-RS-1H	15W	6500 K	1500	44 × 600 × 64	Radar Sensörlü 1 Saat Acil Kit	12	\$127,4
	BLT-E1-0013-RS-3H	15W	6500 K	1500	44 × 600 × 64	Radar Sensörlü 3 Saat Acil Kit	12	\$142,3
	BLT-E1-0011	30W	4000 K	3000	44 × 1200 × 64	-	12	\$55,1
	BLT-E1-0011-1H	30W	4000 K	3000	44 × 1200 × 64	1 Saat Acil Kit	12	\$113,3
	BLT-E1-0011-3H	30W	4000 K	3000	44 × 1200 × 64	3 Saat Acil Kit	12	\$128,3
	BLT-E1-0011-RS	30W	4000 K	3000	44 × 1200 × 64	Radar Sensörlü	12	\$86,9
	BLT-E1-0011-RS-1H	30W	4000 K	3000	44 × 1200 × 64	Radar Sensörlü 1 Saat Acil Kit	12	\$143,3
	BLT-E1-0011-RS-3H	30W	4000 K	3000	44 × 1200 × 64	Radar Sensörlü 3 Saat Acil Kit	12	\$158,2
	BLT-E1-0015	30W	6500 K	3000	44 × 1200 × 64	-	12	\$55,1
	BLT-E1-0015-1H	30W	6500 K	3000	44 × 1200 × 64	1 Saat Acil Kit	12	\$113,3
	BLT-E1-0015-3H	30W	6500 K	3000	44 × 1200 × 64	3 Saat Acil Kit	12	\$128,3
	BLT-E1-0015-RS	30W	6500 K	3000	44 × 1200 × 64	Radar Sensörlü	12	\$86,9
	BLT-E1-0015-RS-1H	30W	6500 K	3000	44 × 1200 × 64	Radar Sensörlü 1 Saat Acil Kit	12	\$143,3
	BLT-E1-0015-RS-3H	30W	6500 K	3000	44 × 1200 × 64	Radar Sensörlü 3 Saat Acil Kit	12	\$158,2

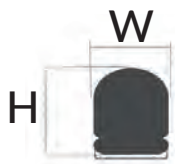

L



LED ELIPS ETANJ ARMATÜR

LED ELIPS WATERPROOF ARMATURE

Teknik Özellikler

Technical Specifications

Gövde : Polikarbonat
Body : Polycarbonate

Gövde Renkleri : Gri
Body Colors : Grey

Kapak : Polikarbonat
Cover : Polycarbonate

Kapak Rengi : Gri
Cover Color : Grey

Renksel Geri Verim : 80
Color Rendering Index : 80

IP Derecesi : IP65
IP Rating : IP65

IK Derecesi : IK09
IK Rating : IK09

Elektriksel Koruma : Sınıf II
Electrical Protection : Class II

Çalışma Sıcaklığı : -20°C / 45°C
Operating Temp. Range : -20°C / 45°C

3000 K OPSİYONDUR
L : 1500 MM OPSİYONU VARDIR

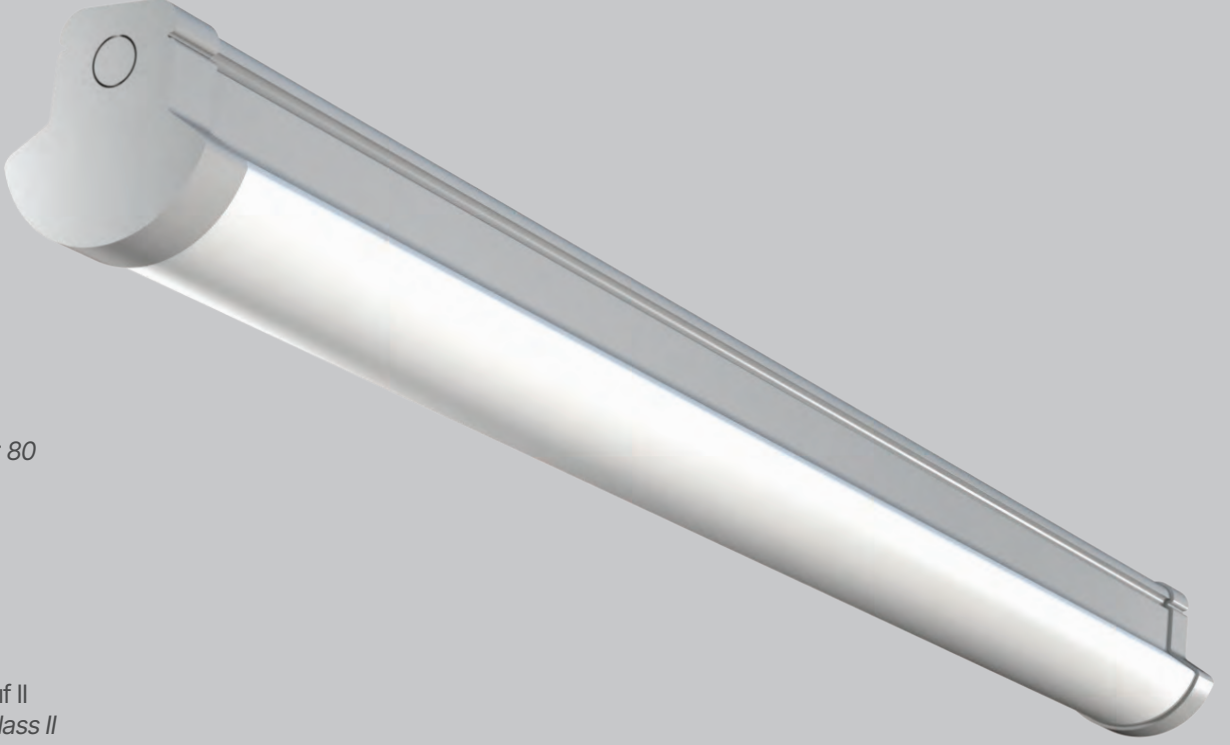

LED

3
YIL
GARANTİ

50.000
SAAT

IP65



LED ELIPS ETANJ ARMATÜR

IP65 koruma standartlarında polikarbon gövde ve difüzör yapısı; neme, toza, doğrudan su ve darbelere karşı etkindir. Led aydınlatma ve difüzör tasarımı, her türlü alanda yüksek ışık verimliliği ve konforlu görüş sağlar. Kolay montaj ve bakım imkanları sunar.







LED ELIPS WATERPROOF ARMATURE

Polycarbonate body and diffuser structure in IP65 protection standards; It is effective against moisture, dust, direct water and impacts. Led lighting and diffuser design provide high luminous efficiency and comfortable vision in all kinds of areas. It offers easy installation and maintenance opportunities.



LED ELIPS ETANJ ARMATÜR

LED ELIPS WATERPROOF ARMATURE

Enerji Verimliliği Sınıfı Energy Efficiency Class	Ürün Kodu Product Code	Güç (W) Power	Renk Sıcaklığı (K) Color Temperature	Işık Akısı (Lm) Luminous Flux	Boyutlar (WxLxH) mm Dimensions	Opsiyonlar Options	Koli Adeti Quantity in Carton	Fiyat Price
	BL-E1-0010	20W	4000 K	1800	75 × 600 × 75	-	12	\$20,2
	BL-E1-0010-1H	20W	4000 K	1800	75 × 600 × 75	1 Saat Acil Kit	12	\$76,0
	BL-E1-0010-3H	20W	4000 K	1800	75 × 600 × 75	3 Saat Acil Kit	12	\$91,0
	BL-E1-0010-RS	20W	4000 K	1800	75 × 600 × 75	Radar Sensörlü	12	\$30,2
	BL-E1-0010-RS-1H	20W	4000 K	1800	75 × 600 × 75	Radar Sensörlü 1 Saat Acil Kit	12	\$79,0
	BL-E1-0010-RS-3H	20W	4000 K	1800	75 × 600 × 75	Radar Sensörlü 3 Saat Acil Kit	12	\$94,0
	BL-E1-0014	20W	6500 K	1800	75 × 600 × 75	-	12	\$20,2
	BL-E1-0014-1H	20W	6500 K	1800	75 × 600 × 75	1 Saat Acil Kit	12	\$76,0
	BL-E1-0014-3H	20W	6500 K	1800	75 × 600 × 75	3 Saat Acil Kit	12	\$91,0
	BL-E1-0014-RS	20W	6500 K	1800	75 × 600 × 75	Radar Sensörlü	12	\$30,2
	BL-E1-0014-RS-1H	20W	6500 K	1800	75 × 600 × 75	Radar Sensörlü 1 Saat Acil Kit	12	\$79,0
	BL-E1-0014-RS-3H	20W	6500 K	1800	75 × 600 × 75	Radar Sensörlü 3 Saat Acil Kit	12	\$94,0
	BL-E1-0012	40W	4000 K	3600	75 × 1200 × 75	-	12	\$35,3
	BL-E1-0012-1H	40W	4000 K	3600	75 × 1200 × 75	1 Saat Acil Kit	12	\$88,6
	BL-E1-0012-3H	40W	4000 K	3600	75 × 1200 × 75	3 Saat Acil Kit	12	\$105,7
	BL-E1-0012-RS	40W	4000 K	3600	75 × 1200 × 75	Radar Sensörlü	12	\$56,2
	BL-E1-0012-RS-1H	40W	4000 K	3600	75 × 1200 × 75	Radar Sensörlü 1 Saat Acil Kit	12	\$91,6
	BL-E1-0012-RS-3H	40W	4000 K	3600	75 × 1200 × 75	Radar Sensörlü 3 Saat Acil Kit	12	\$108,7
	BL-E1-0016	40W	6500 K	3600	75 × 1200 × 75	-	12	\$35,3
	BL-E1-0016-1H	40W	6500 K	3600	75 × 1200 × 75	1 Saat Acil Kit	12	\$88,6
	BL-E1-0016-3H	40W	6500 K	3600	75 × 1200 × 75	3 Saat Acil Kit	12	\$105,7
	BL-E1-0016-RS	40W	6500 K	3600	75 × 1200 × 75	Radar Sensörlü	12	\$56,2
	BL-E1-0016-RS-1H	40W	6500 K	3600	75 × 1200 × 75	Radar Sensörlü 1 Saat Acil Kit	12	\$91,6
	BL-E1-0016-RS-3H	40W	6500 K	3600	75 × 1200 × 75	Radar Sensörlü 3 Saat Acil Kit	12	\$108,7



LED ELIPS ETANJ ARMATÜR TSE

LED ELIPS WATERPROOF ARMATURE TSE

Teknik Özellikler Technical Specifications

Gövde : Polikarbonat
Body : Polycarbonate

Gövde Renkleri : Gri
Body Colors : Grey

Kapak : Polikarbonat
Cover : Polycarbonate

Kapak Rengi : Gri
Cover Color : Grey

Renksel Geri Verim : 80
Color Rendering Index : 80

IP Derecesi : IP65
IP Rating : IP65

IK Derecesi : IK09
IK Rating : IK09

Elektriksel Koruma : Sınıf II
Electrical Protection : Class II

Çalışma Sıcaklığı : -20°C / 45°C
Operating Temp. Range : -20°C / 45°C

3000 K OPSİYONDUR
L : 1500 MM OPSİYONU VARDIR

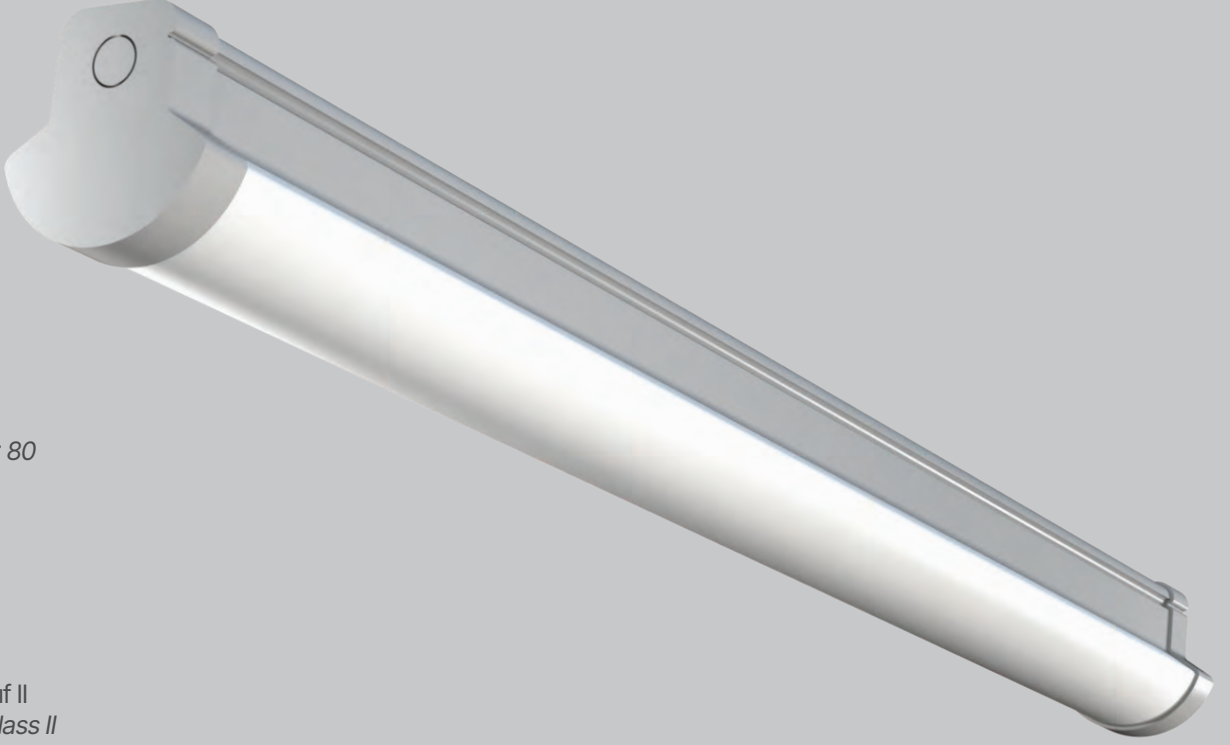

LED

3
YIL
GARANTİ

50.000
SAAT

IP65



LED ELIPS ETANJ ARMATÜR TSE

IP65 koruma standartlarında polikarbon gövde ve difüzör yapısı; neme, toza, doğrudan su ve darbelere karşı etkindir. Led aydınlatma ve difüzör tasarımı, her türlü alanda yüksek ışık verimliliği ve konforlu görüş sağlar. Kolay montaj ve bakım imkanları sunar.







LED ELIPS WATERPROOF ARMATURE TSE

Polycarbonate body and diffuser structure in IP65 protection standards; It is effective against moisture, dust, direct water and impacts. Led lighting and diffuser design provide high luminous efficiency and comfortable vision in all kinds of areas. It offers easy installation and maintenance opportunities.



LED ELIPS ETANJ ARMATÜR TSE

LED ELIPS WATERPROOF ARMATURE TSE

Enerji Verimliliği Sınıfı Energy Efficiency Class	Ürün Kodu Product Code	Güç (W) Power	Renk Sıcaklığı (K) Color Temperature	Işık Akısı (Lm) Luminous Flux	Boyutlar (WxLxH) mm Dimensions	Opsiyonlar Options	Koli Adeti Quantity in Carton	Fiyat Price
	BLT-E1-0010	20W	4000 K	2000	75 x 600 x 75	-	12	\$41,9
	BLT-E1-0010-1H	20W	4000 K	2000	75 x 600 x 75	1 Saat Acil Kit	12	\$99,3
	BLT-E1-0010-3H	20W	4000 K	2000	75 x 600 x 75	3 Saat Acil Kit	12	\$114,3
	BLT-E1-0010-RS	20W	4000 K	2000	75 x 600 x 75	Radar Sensörlü	12	\$74,1
	BLT-E1-0010-RS-1H	20W	4000 K	2000	75 x 600 x 75	Radar Sensörlü 1 Saat Acil Kit	12	\$128,6
	BLT-E1-0010-RS-3H	20W	4000 K	2000	75 x 600 x 75	Radar Sensörlü 3 Saat Acil Kit	12	\$143,6
	BLT-E1-0014	20W	6500 K	2000	75 x 600 x 75	-	12	\$41,9
	BLT-E1-0014-1H	20W	6500 K	2000	75 x 600 x 75	1 Saat Acil Kit	12	\$99,3
	BLT-E1-0014-3H	20W	6500 K	2000	75 x 600 x 75	3 Saat Acil Kit	12	\$114,3
	BLT-E1-0014-RS	20W	6500 K	2000	75 x 600 x 75	Radar Sensörlü	12	\$74,1
	BLT-E1-0014-RS-1H	20W	6500 K	2000	75 x 600 x 75	Radar Sensörlü 1 Saat Acil Kit	12	\$128,6
	BLT-E1-0014-RS-3H	20W	6500 K	2000	75 x 600 x 75	Radar Sensörlü 3 Saat Acil Kit	12	\$143,6
	BLT-E1-0012	40W	4000 K	4000	75 x 1200 x 75	-	12	\$58,1
	BLT-E1-0012-1H	40W	4000 K	4000	75 x 1200 x 75	1 Saat Acil Kit	12	\$113,2
	BLT-E1-0012-3H	40W	4000 K	4000	75 x 1200 x 75	3 Saat Acil Kit	12	\$129,4
	BLT-E1-0012-RS	40W	4000 K	4000	75 x 1200 x 75	Radar Sensörlü	12	\$88,8
	BLT-E1-0012-RS-1H	40W	4000 K	4000	75 x 1200 x 75	Radar Sensörlü 1 Saat Acil Kit	12	\$125,7
	BLT-E1-0012-RS-3H	40W	4000 K	4000	75 x 1200 x 75	Radar Sensörlü 3 Saat Acil Kit	12	\$157,7
	BLT-E1-0016	40W	6500 K	4000	75 x 1200 x 75	-	12	\$58,1
	BLT-E1-0016-1H	40W	6500 K	4000	75 x 1200 x 75	1 Saat Acil Kit	12	\$113,2
	BLT-E1-0016-3H	40W	6500 K	4000	75 x 1200 x 75	3 Saat Acil Kit	12	\$129,4
	BLT-E1-0016-RS	40W	6500 K	4000	75 x 1200 x 75	Radar Sensörlü	12	\$88,8
	BLT-E1-0016-RS-1H	40W	6500 K	4000	75 x 1200 x 75	Radar Sensörlü 1 Saat Acil Kit	12	\$125,7
	BLT-E1-0016-RS-3H	40W	6500 K	4000	75 x 1200 x 75	Radar Sensörlü 3 Saat Acil Kit	12	\$157,7



EX-PROOF LED ETANJ

EX-PROOF LED ETANJ

Teknik Özellikler Technical Specifications

Gövde : Polikarbonat (PC)
Body : Polycarbonate

Gövde Renkleri : Turuncu
Body Colors : Orange

Difüzör : Polikarbonat (PC)
Diffuser : Polycarbonate

Renksel Geri Verim : 80
Color Rendering Index : 80

IP Derecesi : IP65
IP Rating : IP65

IK Derecesi : IK08
IK Rating : IK08

Elektriksel Koruma : Sınıf I
Electrical Protection : Class I

Çalışma Sıcaklığı : -20°C / 45°C
Operating Temp. Range : -20°C / 45°C

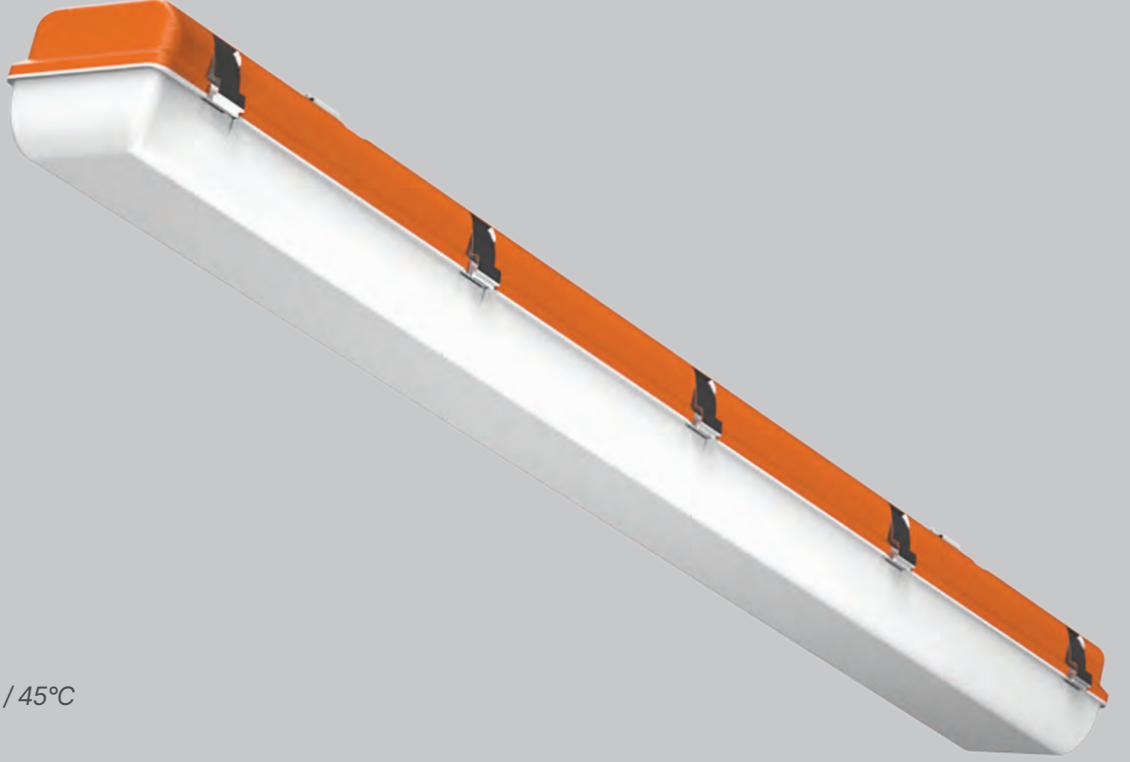

EX-PROOF LED ETANJ

Yüksek darbe dayanımlı polikarbonat gövde ve ideal tasarım elektrostatik toz boya ile sararma ve korozyona karşı dayanıklıdır. Polikarbon difüzör, optik homojen ışık yayılımı ve yüksek ışık geçirgenliği sağlar. Bu ürün kullanım yeri ve talep edilen normlara uygun ex-proof özelliklere sahiptir.

*Ex-proof Led Etanj Armatür, grup II tehlikeli açık ya da kapalı alanlarda kullanılmaktadır.

*Ex-proof kelimesi "Explosion-proof"un kısaltılmış halidir. Türkçede "patlamaya dayanıklı" olarak bilinmektedir.

Petrol ürün tesisleri, gaz istasyonları, rafineriler, kömür madenleri ve demir-çelik sanayi ayrıca şeker ve un fabrikaları gibi. Tehlikeli ve patlayıcı maddeler içeren çalışma ortamlarında patlamaları önlemek için güvenlik amaçlı kullanılan özel ürünlerdir.

EX-PROOF LED ETANJ

High impact polycarbonate body and ideal design electrostatic powder paint are resistant to yellowing and corrosion. The polycarbonate diffuser provides optical homogeneous light distribution and high light transmission. This product has ex-proof features by the place of use and the requested norms.

*Ex-proof Led lighting fixtures are used in Group II hazardous areas at indoor or outdoor services.



*The word exproof is the abbreviation of "Explosion-proof". It is known as "explosion-proof" in Turkish.

These are specific products used for safety purposes to prevent explosions in working environments containing hazardous and explosive substances. Such as oil product plants, gas stations, refineries, coal mines and iron and steel industries as well as sugar and flour mills.



EX-PROOF LED ETANJ

EX-PROOF LED ETANJ

Enerji Verimliliği Sınıfı Energy Efficiency Class	Ürün Kodu Product Code	Güç (W) Power	Renk Sıcaklığı (K) Color Temperature	Işık Akısı (Lm) Luminous Flux	Boyutlar (WxLxH) mm Dimensions	Renk Color	Koli Adeti Quantity in Carton	Fiyat Price
	BL-EX-0001	20W	3000 K	2200	95 × 670 × 125	Turuncu	1	\$132,70
	BL-EX-0002	20W	4000 K	2200	95 × 670 × 125	Turuncu	1	\$132,70
	BL-EX-0003	20W	6500 K	2200	95 × 670 × 125	Turuncu	1	\$132,70
	BL-EX-0004	40W	3000 K	4400	95 × 1270 × 125	Turuncu	1	\$151,00
	BL-EX-0005	40W	4000 K	4400	95 × 1270 × 125	Turuncu	1	\$151,00
	BL-EX-0006	40W	6500 K	4400	95 × 1270 × 125	Turuncu	1	\$151,00
	BL-EX-0007	60W	3000 K	6600	95 × 1270 × 125	Turuncu	1	\$169,30
	BL-EX-0008	60W	4000 K	6600	95 × 1270 × 125	Turuncu	1	\$169,30
	BL-EX-0009	60W	6500 K	6600	95 × 1270 × 125	Turuncu	1	\$169,30

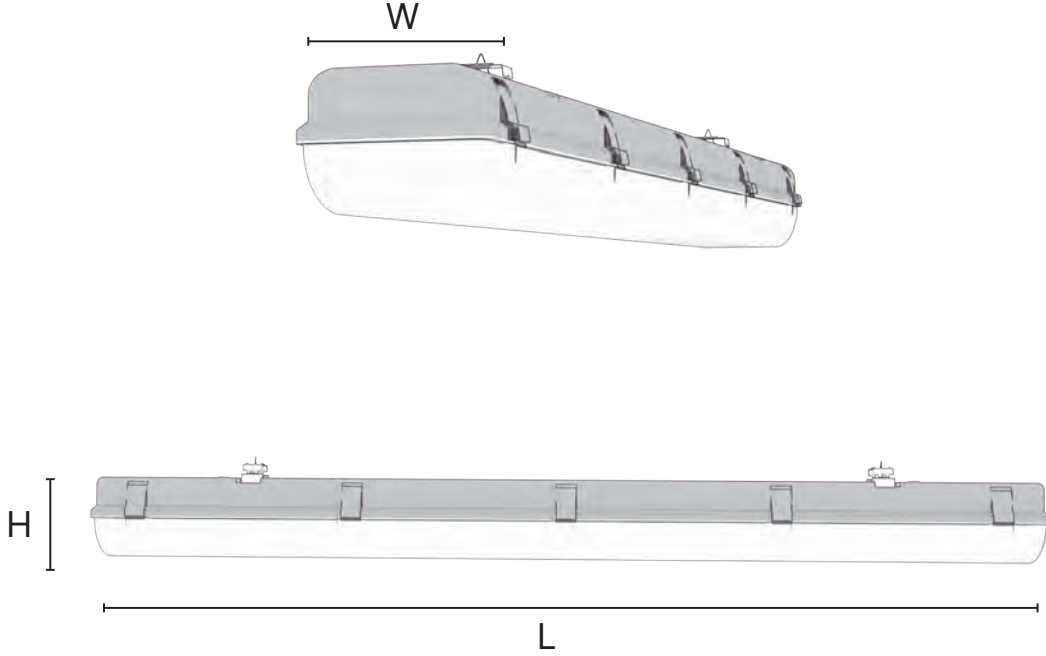

T5 LED TUBE ARMATÜR

T5 LED TUBE ARMATURE

Teknik Özellikler

Technical Specifications

Gövde : Polikarbonat-TUBE
Body : Polycarbonate

Gövde Renkleri : Beyaz
Body Colors : White

Difüzör : Polikarbonat (PC)
Diffuser : Polycarbonate

Renksel Geri Verim : 80
Color Rendering Index : 80

IP Derecesi : IP20
IP Rating : IP20

IK Derecesi : IK02
IK Rating : IK02

Elektriksel Koruma : Sınıf I
Electrical Protection : Class I

Çalışma Sıcaklığı : -20°C / 45°C
Operating Temp. Range : -20°C / 45°C

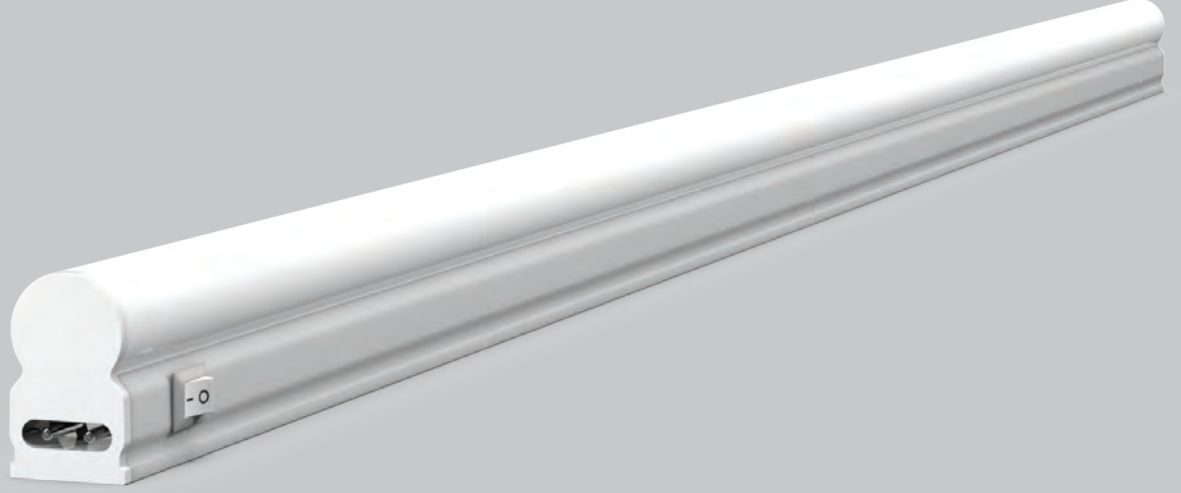

LED

1 YIL
GARANTİ

50.000
SAAT

T5 LED TUBE ARMATÜR

Sıcak ışık-nötr ışık-beyaz ışık seçenekleri sunan entegre sürücü ve led çiplerin verimli kullanımı ile sorunsuz ısı dağılımına ve uzun hizmet ömrüne sahiptir.

Ev, ofis, showromlar, alışveriş merkezleri, hastaneler ve oteller gibi iç mekan uygulamaları için tasarlanmış, mükemmel bir aydınlatma çözümüdür.













T5 LED TUBE ARMATÜRE

It has problem-free heat dissipation and long service life with the efficient use of an integrated driver and led chips that offer warm light-neutral light-white light options. It is an excellent lighting solution designed for indoor applications such as homes, offices, showrooms, shopping malls, hospitals and hotels.



T5 LED TUBE ARMATÜR

T5 LED TUBE ARMATURE

Enerji Verimliliği Sınıfı Energy Efficiency Class	Ürün Kodu Product Code	Güç (W) Power	Renk Sıcaklığı (K) Color Temperature	Işık Akısı (Lm) Luminous Flux	Boyutlar (WxLxH) mm Dimensions	Renk Color	Koli Adeti Quantity in Carton	Fiyat Price
	BL-TB-0001	4W	6500 K	380	25 × 300 × 35	Beyaz	20	\$8,1
	BL-TB-0002	4W	4000 K	380	25 × 300 × 35	Beyaz	20	\$8,1
	BL-TB-0003	4W	3000 K	380	25 × 300 × 35	Beyaz	20	\$8,1
	BL-TB-0004	8W	6500 K	760	25 × 600 × 35	Beyaz	20	\$10,0
	BL-TB-0005	8W	4000 K	760	25 × 600 × 35	Beyaz	20	\$10,0
	BL-TB-0006	8W	3000 K	760	25 × 600 × 35	Beyaz	20	\$10,0
	BL-TB-0007	12W	6500 K	1150	25 × 900 × 35	Beyaz	20	\$12,0
	BL-TB-0008	12W	4000 K	1150	25 × 900 × 35	Beyaz	20	\$12,0
	BL-TB-0009	12W	3000 K	1150	25 × 900 × 35	Beyaz	20	\$12,0
	BL-TB-0010	16W	6500 K	1500	25 × 1200 × 35	Beyaz	20	\$13,4
	BL-TB-0011	16W	4000 K	1500	25 × 1200 × 35	Beyaz	20	\$13,4
	BL-TB-0012	16W	3000 K	1500	25 × 1200 × 35	Beyaz	20	\$13,4

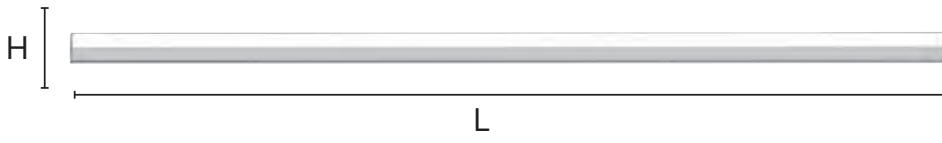

AYNA ÜSTÜ ARMATÜR ABOVE MIRROR ARMATURE

Teknik Özellikler Technical Specifications

Gövde : Krom
Body : Chrome

Çalışma Gerilimi : 220-240 V AC
Operating Voltage : 220-240 V AC

Gövde Renkleri : Metalik
Body Colors : Metallic

Renksel Geri Verim : 80
Color Rendering Index : 80

IP Derecesi : IP20
IP Rating : IP20

Çalışma Sıcaklığı : -20 C / 45 C
Operating Temp. Range : -20 C / 45 C



24 W



12 W



AYNA ÜSTÜ ARMATÜR

Akrilik difüzör ve homojen led aydınlatma sağlayan mafsallı başlığıyla işlevsel. Paslanmaz krom kaplamalı gövdesi ile şık ve hijyenik bir aydınlatma armatürüdür.







ABOVE MIRROR ARMATURE

Functional with an acrylic diffuser and an articulated head that provides homogeneous LED lighting. It is a stylish and hygienic lighting fixture with its stainless chrome plated body.



AYNA ÜSTÜ ARMATÜR

ABOVE MIRROR ARMATURE

Enerji Verimliliği Sınıfı Energy Efficiency Class	Ürün Kodu Product Code	Güç (W) Power	Renk Sıcaklığı (K) Color Temperature	Işık Akısı (Lm) Luminous Flux	Boyutlar (WxLxH) mm Dimensions	Renk Color	Koli Adeti Quantity in Carton	Fiyat Price
	BL-AU-0001	12W	3000 K	840	115 × 570 × 170	Metalik	15	\$61,0
	BL-AU-0002	12W	4000 K	840	115 × 570 × 170	Metalik	15	\$61,0
	BL-AU-0003	12W	6500 K	840	115 × 570 × 170	Metalik	15	\$61,0
	BL-AU-1001	24W	3000 K	1680	90 × 570 × 220	Metalik	12	\$72,6
	BL-AU-1002	24W	4000 K	1680	90 × 570 × 220	Metalik	12	\$72,6
	BL-AU-1003	24W	6500 K	1680	90 × 570 × 220	Metalik	12	\$72,6

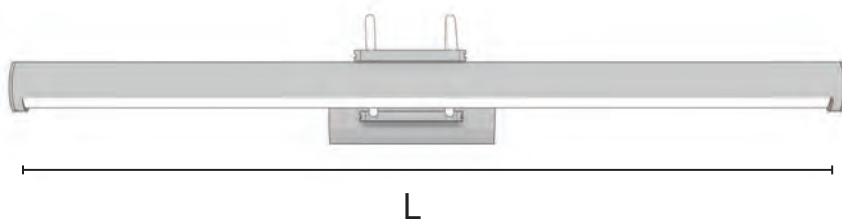
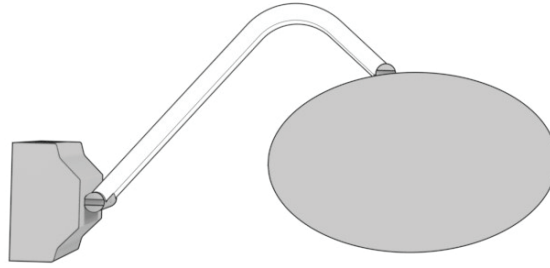
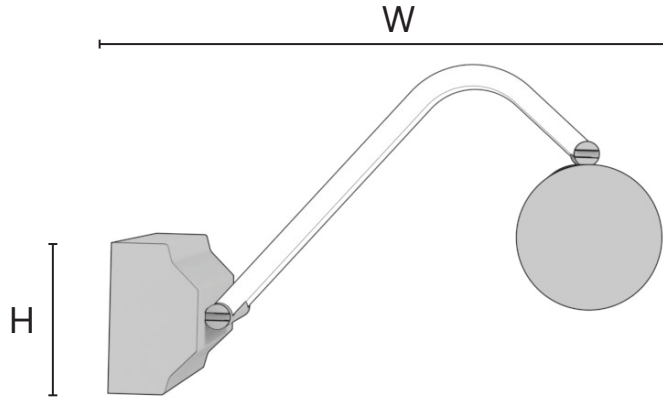

OVAL LED GLOP ARMATÜR

OVAL LED GLOBE ARMATURE

Teknik Özellikler

Technical Specifications

Gövde : DKP Sac
Body : DKP Metal Sheet

Gövde Renkleri : Beyaz
Body Colors : White

Difüzör : Akrilik
Diffuser : Acrylic

Renksel Geri Verim : 80
Color Rendering Index : 80

IP Derecesi : IP20
IP Rating : IP20

IK Derecesi : IK03
IK Rating : IK03

Elektriksel Koruma : Sınıf I
Electrical Protection : Class I

Çalışma Sıcaklığı : -20°C / 45°C
Operating Temp. Range : -20°C / 45°C



LED

3
YIL
GARANTİ

50.000
SAAT



OVAL LED GLOP ARMATÜR

Bu armatürler fonksiyonel üst kapaklarından dolayı Glop adını almıştır. Glop ürünler yüzeysel bir aydınlatma yerine daha geniş, detaylı ve homojen aydınlatma sağlamaktadır.

OVAL LED GLOBE ARMATURE

These luminaires are named Glop because of their functional top covers. Glop products provide expanse, detailed and homogeneous lighting instead of superficial lighting.



OVAL LED GLOP ARMATÜR

OVAL LED GLOBE ARMATURE

Enerji Verimliliği Sınıfı Energy Efficiency Class	Ürün Kodu Product Code	Güç (W) Power	Renk Sıcaklığı (K) Color Temperature	Işık Akısı (Lm) Luminous Flux	Boyutlar (ØxH) mm Dimensions	Opsiyonlar Options	Koli Adeti Quantity in Carton	Fiyat Price
	BL-G1-0002	12W	3000 K	1080	260 × 83	-	24	\$22,9
	BL-G1-0002-1H	12W	3000 K	1080	260 × 83	1 Saat Acil Kit	24	\$36,4
	BL-G1-0002-3H	12W	3000 K	1080	260 × 83	3 Saat Acil Kit	24	\$45,0
	BL-G1-0002-RS	12W	3000 K	1080	260 × 83	Radar Sensörü	24	\$33,0
	BL-G1-0002-RS-1H	12W	3000 K	1080	260 × 83	Radar Sensör & 1 Saat Acil Kit	24	\$47,7
	BL-G1-0002-RS-3H	12W	3000 K	1080	260 × 83	Radar Sensör & 3 Saat Acil Kit	24	\$55,0
	BL-G1-0014	12W	4000 K	1080	260 × 83	-	24	\$22,9
	BL-G1-0014-1H	12W	4000 K	1080	260 × 83	1 Saat Acil Kit	24	\$36,6
	BL-G1-0014-3H	12W	4000 K	1080	260 × 83	3 Saat Acil Kit	24	\$45,0
	BL-G1-0014-RS	12W	4000 K	1080	260 × 83	Radar Sensörü	24	\$33,0
	BL-G1-0014-RS-1H	12W	4000 K	1080	260 × 83	Radar Sensör & 1 Saat Acil Kit	24	\$47,7
	BL-G1-0014-RS-3H	12W	4000 K	1080	260 × 83	Radar Sensör & 3 Saat Acil Kit	24	\$55,0
	BL-G1-0008	12W	6500 K	1080	260 × 83	-	24	\$22,9
	BL-G1-0008-1H	12W	6500 K	1080	260 × 83	1 Saat Acil Kit	24	\$36,4
	BL-G1-0008-3H	12W	6500 K	1080	260 × 83	3 Saat Acil Kit	24	\$45,0
	BL-G1-0008-RS	12W	6500 K	1080	260 × 83	Radar Sensörü	24	\$33,0
	BL-G1-0008-RS-1H	12W	6500 K	1080	260 × 83	Radar Sensör & 1 Saat Acil Kit	24	\$47,7
	BL-G1-0008-RS-3H	12W	6500 K	1080	260 × 83	Radar Sensör & 3 Saat Acil Kit	24	\$55,0
	BL-G1-0004	18W	3000 K	1620	330 × 96	-	12	\$30,3
	BL-G1-0004-1H	18W	3000 K	1620	330 × 96	1 Saat Acil Kit	12	\$43,3
	BL-G1-0004-3H	18W	3000 K	1620	330 × 96	3 Saat Acil Kit	12	\$50,5
	BL-G1-0004-RS	18W	3000 K	1620	330 × 96	Radar Sensörü	12	\$38,4
	BL-G1-0004-RS-1H	18W	3000 K	1620	330 × 96	Radar Sensör & 1 Saat Acil Kit	12	\$52,8
	BL-G1-0004-RS-3H	18W	3000 K	1620	330 × 96	Radar Sensör & 3 Saat Acil Kit	12	\$61,9
	BL-G1-0016	18W	4000 K	1620	330 × 96	-	12	\$30,3
	BL-G1-0016-1H	18W	4000 K	1620	330 × 96	1 Saat Acil Kit	12	\$43,3
	BL-G1-0016-3H	18W	4000 K	1620	330 × 96	3 Saat Acil Kit	12	\$50,5



H

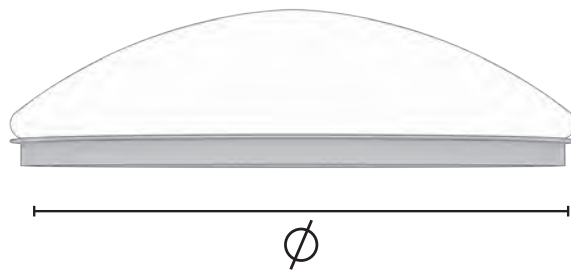

Teknik veri / Datasheet

OVAL LED GLOP ARMATÜR

OVAL LED GLOBE ARMATURE

Teknik Özellikler

Technical Specifications

Gövde : DKP Sac
Body : DKP Metal Sheet

Gövde Renkleri : Beyaz
Body Colors : White

Difüzör : Akrilik
Diffuser : Acrylic

Renksel Geri Verim : 80
Color Rendering Index : 80

IP Derecesi : IP20
IP Rating : IP20

IK Derecesi : IK03
IK Rating : IK03

Elektriksel Koruma : Sınıf I
Electrical Protection : Class I

Çalışma Sıcaklığı : -20°C / 45°C
Operating Temp. Range : -20°C / 45°C



LED

3
YIL
GARANTİ

50.000
SAAT



OVAL LED GLOP ARMATÜR

Bu armatürler fonksiyonel üst kapaklarından dolayı Glop adını almıştır. Glop ürünler yüzeysel bir aydınlatma yerine daha geniş, detaylı ve homojen aydınlatma sağlamaktadır.

OVAL LED GLOBE ARMATURE

These luminaires are named Glop because of their functional top covers. Glop products provide expanse, detailed and homogeneous lighting instead of superficial lighting.



OVAL LED GLOP ARMATÜR

OVAL LED GLOBE ARMATURE

Enerji Verimliliği Sınıfı Energy Efficiency Class	Ürün Kodu Product Code	Güç (W) Power	Renk Sıcaklığı (K) Color Temperature	Işık Akısı (Lm) Luminous Flux	Boyutlar (ØxH) mm Dimensions	Opsiyonlar Options	Koli Adeti Quantity in Carton	Fiyat Price
A+ F	BL-G1-0016-RS	18W	4000 K	1620	330 × 96	Radar Sensörlü	12	\$38,4
A+ F	BL-G1-0016-RS-1H	18W	4000 K	1620	330 × 96	Radar Sensör & 1 Saat Acil Kit	12	\$52,8
A+ F	BL-G1-0016-RS-3H	18W	4000 K	1620	330 × 96	Radar Sensör & 3 Saat Acil Kit	12	\$61,9
A+ F	BL-G1-0010	18W	6500 K	1620	330 × 96	-	12	\$30,3
A+ F	BL-G1-0010-1H	18W	6500 K	1620	330 × 96	1 Saat Acil Kit	12	\$43,3
A+ F	BL-G1-0010-3H	18W	6500 K	1620	330 × 96	3 Saat Acil Kit	12	\$50,5
A+ F	BL-G1-0010-RS	18W	6500 K	1620	330 × 96	Radar Sensörlü	12	\$38,4
A+ F	BL-G1-0010-RS-1H	18W	6500 K	1620	330 × 96	Radar Sensör & 1 Saat Acil Kit	12	\$53,2
A+ F	BL-G1-0010-RS-3H	18W	6500 K	1620	330 × 96	Radar Sensör & 3 Saat Acil Kit	12	\$61,9
A+ F	BL-G1-0006	24W	3000 K	2160	380 × 100	-	6	\$37,1
A+ F	BL-G1-0006-1H	24W	3000 K	2160	380 × 100	1 Saat Acil Kit	6	\$49,4
A+ F	BL-G1-0006-3H	24W	3000 K	2160	380 × 100	3 Saat Acil Kit	6	\$57,9
A+ F	BL-G1-0006-RS	24W	3000 K	2160	380 × 100	Radar Sensörlü	6	\$46,3
A+ F	BL-G1-0006-RS-1H	24W	3000 K	2160	380 × 100	Radar Sensör & 1 Saat Acil Kit	6	\$59,1
A+ F	BL-G1-0006-RS-3H	24W	3000 K	2160	380 × 100	Radar Sensör & 3 Saat Acil Kit	6	\$69,5
A+ F	BL-G1-0018	24W	4000 K	2160	380 × 100	-	6	\$37,1
A+ F	BL-G1-0018-1H	24W	4000 K	2160	380 × 100	1 Saat Acil Kit	6	\$49,4
A+ F	BL-G1-0018-3H	24W	4000 K	2160	380 × 100	3 Saat Acil Kit	6	\$57,9
A+ F	BL-G1-0018-RS	24W	4000 K	2160	380 × 100	Radar Sensörlü	6	\$46,3
A+ F	BL-G1-0018-RS-1H	24W	4000 K	2160	380 × 100	Radar Sensör & 1 Saat Acil Kit	6	\$59,1
A+ F	BL-G1-0018-RS-3H	24W	4000 K	2160	380 × 100	Radar Sensör & 3 Saat Acil Kit	6	\$69,5
A+ F	BL-G1-0012	24W	6500 K	2160	380 × 100	-	6	\$37,1
A+ F	BL-G1-0012-1H	24W	6500 K	2160	380 × 100	1 Saat Acil Kit	6	\$49,4
A+ F	BL-G1-0012-3H	24W	6500 K	2160	380 × 100	3 Saat Acil Kit	6	\$57,9
A+ F	BL-G1-0012-RS	24W	6500 K	2160	380 × 100	Radar Sensörlü	6	\$46,3
A+ F	BL-G1-0012-RS-1H	24W	6500 K	2160	380 × 100	Radar Sensör & 1 Saat Acil Kit	6	\$59,1
A+ F	BL-G1-0012-RS-3H	24W	6500 K	2160	380 × 100	Radar Sensör & 3 Saat Acil Kit	6	\$69,5



H

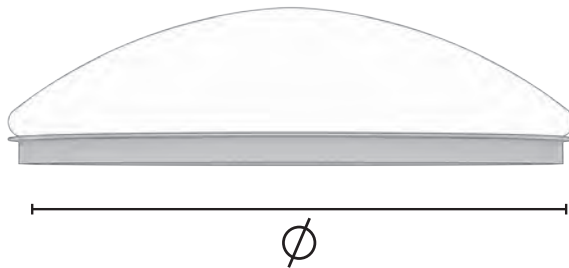

Teknik veri / Datasheet

FLAT LED GLOP ARMATÜR

FLAT LED GLOBE ARMATURE

Teknik Özellikler

Technical Specifications

Gövde : DKP Sac
Body : DKP Metal Sheet

Gövde Renkleri : Beyaz
Body Colors : White

Difüzör : Akrilik
Diffuser : Acrylic

Renksel Geri Verim : 80
Color Rendering Index : 80

IP Derecesi : IP20
IP Rating : IP20

IK Derecesi : IK03
IK Rating : IK03

Elektriksel Koruma : Sınıf I
Electrical Protection : Class I

Çalışma Sıcaklığı : -20°C / 45°C
Operating Temp. Range : -20°C / 45°C



FLAT LED GLOP ARMATÜR

Bu armatürler fonksiyonel üst kapaklarından dolayı Glop adını almıştır. Glop ürünler yüzeysel bir aydınlatma yerine daha geniş, detaylı ve homojen aydınlatma sağlamaktadır.

FLAT LED GLOBE ARMATURE

These luminaires are named Glop because of their functional top covers. Glop products provide expanse, detailed and homogeneous lighting instead of superficial lighting.



FLAT LED GLOP ARMATÜR

FLAT LED GLOBE ARMATURE

Enerji Verimliliği Sınıfı Energy Efficiency Class	Ürün Kodu Product Code	Güç (W) Power	Renk Sıcaklığı (K) Color Temperature	Işık Akısı (Lm) Luminous Flux	Boyutlar (ØxH) mm Dimensions	Opsiyonlar Options	Koli Adeti Quantity in Carton	Fiyat Price
	BL-G1-0001	12W	3000 K	1080	260 × 83	-	24	\$22,9
	BL-G1-0001-1H	12W	3000 K	1080	260 × 83	1 Saat Acil Kit	24	\$36,4
	BL-G1-0001-3H	12W	3000 K	1080	260 × 83	3 Saat Acil Kit	24	\$45,0
	BL-G1-0001-RS	12W	3000 K	1080	260 × 83	Radar Sensörlü	24	\$33,0
	BL-G1-0001-RS-1H	12W	3000 K	1080	260 × 83	Radar Sensörlü 1 Saat Acil Kit	24	\$47,7
	BL-G1-0001-RS-3H	12W	3000 K	1080	260 × 83	Radar Sensörlü 3 Saat Acil Kit	24	\$55,0
	BL-G1-0013	12W	4000 K	1080	260 × 83	-	24	\$22,9
	BL-G1-0013-1H	12W	4000 K	1080	260 × 83	1 Saat Acil Kit	24	\$36,6
	BL-G1-0013-3H	12W	4000 K	1080	260 × 83	3 Saat Acil Kit	24	\$45,0
	BL-G1-0013-RS	12W	4000 K	1080	260 × 83	Radar Sensörlü	24	\$33,0
	BL-G1-0013-RS-1H	12W	4000 K	1080	260 × 83	Radar Sensörlü 1 Saat Acil Kit	24	\$47,7
	BL-G1-0013-RS-3H	12W	4000 K	1080	260 × 83	Radar Sensörlü 3 Saat Acil Kit	24	\$55,0
	BL-G1-0007	12W	6500 K	1080	260 × 83	-	24	\$22,9
	BL-G1-0007-1H	12W	6500 K	1080	260 × 83	1 Saat Acil Kit	24	\$36,4
	BL-G1-0007-3H	12W	6500 K	1080	260 × 83	3 Saat Acil Kit	24	\$45,0
	BL-G1-0007-RS	12W	6500 K	1080	260 × 83	Radar Sensörlü	24	\$33,0
	BL-G1-0007-RS-1H	12W	6500 K	1080	260 × 83	Radar Sensörlü 1 Saat Acil Kit	24	\$47,7
	BL-G1-0007-RS-3H	12W	6500 K	1080	260 × 83	Radar Sensörlü 3 Saat Acil Kit	24	\$55,0
	BL-G1-0003	18W	3000 K	1620	330 × 96	-	12	\$30,3
	BL-G1-0003-1H	18W	3000 K	1620	330 × 96	1 Saat Acil Kit	12	\$43,3
	BL-G1-0003-3H	18W	3000 K	1620	330 × 96	3 Saat Acil Kit	12	\$50,5
	BL-G1-0003-RS	18W	3000 K	1620	330 × 96	Radar Sensörlü	12	\$38,4
	BL-G1-0003-RS-1H	18W	3000 K	1620	330 × 96	Radar Sensörlü 1 Saat Acil Kit	12	\$53,2
	BL-G1-0003-RS-3H	18W	3000 K	1620	330 × 96	Radar Sensörlü 3 Saat Acil Kit	12	\$61,9
	BL-G1-0015	18W	4000 K	1620	330 × 96	-	12	\$30,3
	BL-G1-0015-1H	18W	4000 K	1620	330 × 96	1 Saat Acil Kit	12	\$43,3
	BL-G1-0015-3H	18W	4000 K	1620	330 × 96	3 Saat Acil Kit	12	\$50,5

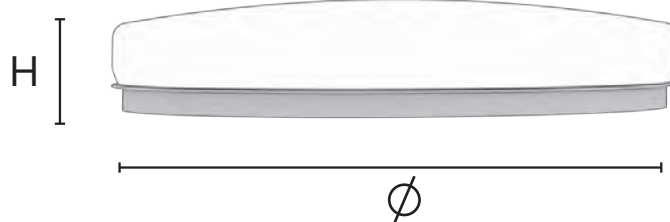

FLAT LED GLOP ARMATÜR

FLAT LED GLOBE ARMATURE

Teknik Özellikler

Technical Specifications

Gövde : DKP Sac
Body : DKP Metal Sheet

Gövde Renkleri : Beyaz
Body Colors : White

Difüzör : Akrilik
Diffuser : Acrylic

Renksel Geri Verim : 80
Color Rendering Index : 80

IP Derecesi : IP20
IP Rating : IP20

IK Derecesi : IK03
IK Rating : IK03

Elektriksel Koruma : Sınıf I
Electrical Protection : Class I

Çalışma Sıcaklığı : -20°C / 45°C
Operating Temp. Range : -20°C / 45°C



FLAT LED GLOP ARMATÜR

Bu armatürler fonksiyonel üst kapaklarından dolayı Glop adını almıştır. Glop ürünler yüzeysel bir aydınlatma yerine daha geniş, detaylı ve homojen aydınlatma sağlamaktadır.

FLAT LED GLOBE ARMATURE

These luminaires are named Glop because of their functional top covers. Glop products provide expanse, detailed and homogeneous lighting instead of superficial lighting.



FLAT LED GLOP ARMATÜR

FLAT LED GLOBE ARMATURE

Enerji Verimliliği Sınıfı Energy Efficiency Class	Ürün Kodu Product Code	Güç (W) Power	Renk Sıcaklığı (K) Color Temperature	Işık Akısı (Lm) Luminous Flux	Boyutlar (ØxH) mm Dimensions	Opsiyonlar Options	Koli Adeti Quantity in Carton	Fiyat Price
A+G F	BL-G1-0015-RS	18W	4000 K	1620	330 × 96	Radar Sensörlü	12	\$38,4
A+G F	BL-G1-0015-RS-1H	18W	4000 K	1620	330 × 96	Radar Sensörlü 1 Saat Acil Kit	12	\$52,8
A+G F	BL-G1-0015-RS-3H	18W	4000 K	1620	330 × 96	Radar Sensörlü 3 Saat Acil Kit	12	\$61,9
A+G F	BL-G1-0009	18W	6500 K	1620	330 × 96	-	12	\$30,3
A+G F	BL-G1-0009-1H	18W	6500 K	1620	330 × 96	1 Saat Acil Kit	12	\$43,3
A+G F	BL-G1-0009-3H	18W	6500 K	1620	330 × 96	3 Saat Acil Kit	12	\$50,5
A+G F	BL-G1-0009-RS	18W	6500 K	1620	330 × 96	Radar Sensörlü	12	\$38,4
A+G F	BL-G1-0009-RS-1H	18W	6500 K	1620	330 × 96	Radar Sensörlü 1 Saat Acil Kit	12	\$53,2
A+G F	BL-G1-0009-RS-3H	18W	6500 K	1620	330 × 96	Radar Sensörlü 3 Saat Acil Kit	12	\$61,9
A+G F	BL-G1-0005	24W	3000 K	2160	380 × 100	-	6	\$37,1
A+G F	BL-G1-0005-1H	24W	3000 K	2160	380 × 100	1 Saat Acil Kit	6	\$49,4
A+G F	BL-G1-0005-3H	24W	3000 K	2160	380 × 100	3 Saat Acil Kit	6	\$57,9
A+G F	BL-G1-0005-RS	24W	3000 K	2160	380 × 100	Radar Sensörlü	6	\$46,3
A+G F	BL-G1-0005-RS-1H	24W	3000 K	2160	380 × 100	Radar Sensörlü 1 Saat Acil Kit	6	\$59,1
A+G F	BL-G1-0005-RS-3H	24W	3000 K	2160	380 × 100	Radar Sensörlü 3 Saat Acil Kit	6	\$69,5
A+G F	BL-G1-0017	24W	4000 K	2160	380 × 100	-	6	\$37,1
A+G F	BL-G1-0017-1H	24W	4000 K	2160	380 × 100	1 Saat Acil Kit	6	\$49,4
A+G F	BL-G1-0017-3H	24W	4000 K	2160	380 × 100	3 Saat Acil Kit	6	\$57,9
A+G F	BL-G1-0017-RS	24W	4000 K	2160	380 × 100	Radar Sensörlü	6	\$46,3
A+G F	BL-G1-0017-RS-1H	24W	4000 K	2160	380 × 100	Radar Sensörlü 1 Saat Acil Kit	6	\$59,1
A+G F	BL-G1-0017-RS-3H	24W	4000 K	2160	380 × 100	Radar Sensörlü 3 Saat Acil Kit	6	\$69,5
A+G F	BL-G1-0011	24W	6500 K	2160	380 × 100	-	6	\$37,1
A+G F	BL-G1-0011-1H	24W	6500 K	2160	380 × 100	1 Saat Acil Kit	6	\$49,4
A+G F	BL-G1-0011-3H	24W	6500 K	2160	380 × 100	3 Saat Acil Kit	6	\$57,9
A+G F	BL-G1-0011-RS	24W	6500 K	2160	380 × 100	Radar Sensörlü	6	\$46,3
A+G F	BL-G1-0011-RS-1H	24W	6500 K	2160	380 × 100	Radar Sensörlü 1 Saat Acil Kit	6	\$59,1
A+G F	BL-G1-0011-RS-3H	24W	6500 K	2160	380 × 100	Radar Sensörlü 3 Saat Acil Kit	6	\$69,5



H

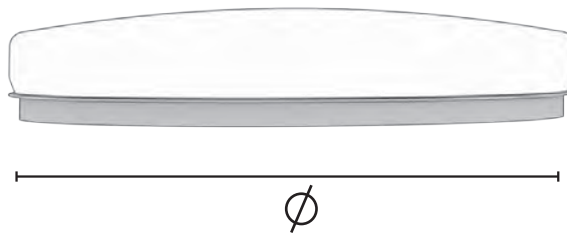

Teknik veri / Datasheet

LED NEMLİYER YUVARLAK GLOP TAVAN ARMATÜR LED NEMLİYER ROUND GLOBE CEILING ARMATURE

Teknik Özellikler Technical Specifications

Gövde : Polikarbonat(PC)
Body : Polycarbonate

Difüzör : Akrilik
Diffuser : Acrylic

Renksel Geri Verim : 80
Color Rendering Index : 80

IP Derecesi : IP65
IP Rating : IP65

IK Derecesi : IK03
IK Rating : IK03

Elektriksel Koruma : Sınıf II
Electrical Protection : Class II

Çalışma Sıcaklığı : -20°C / 45°C
Operating Temp. Range : -20°C / 45°C



LED

3
YIL
GARANTİ

50.000
SAAT

IP65

LED NEMLİYER OVAL GLOP TAVAN ARMATÜR LED NEMLİYER OVAL GLOBE CEILING ARMATURE



LED NEMLİYER GLOP TAVAN ARMATÜR

Bu armatürler fonksiyonel üst kapaklarından dolayı Glop adını almıştır. Glop ürünler yüzeysel bir aydınlatma yerine daha geniş, detaylı ve homojen aydınlatma sağlamaktadır.

LED NEMLİYER GLOBE CEILING ARMATURE

These luminaires are named Glop because of their functional top covers. Glop products provide expanse, detailed and homogeneous lighting instead of superficial lighting.



LED NEMLİYER YUVARLAK GLOP TAVAN ARMATÜR

LED NEMLİYER ROUND GLOBE CEILING ARMATURE

Enerji Verimliliği Sınıfı Energy Efficiency Class	Ürün Kodu Product Code	Güç (W) Power	Renk Sıcaklığı (K) Color Temperature	Işık Akısı (Lm) Luminous Flux	Boyutlar (ØxH) mm Dimensions	Renk Color	Koli Adeti Quantity in Carton	Fiyat Price
	BL-G2-0002	12W	4000 K	1080	175 × 60	Beyaz White	24	\$25,2
	BL-G2-0003	12W	6500 K	1080	175 × 60	Beyaz White	24	\$25,2
	BL-G2-0005	15W	4000 K	1350	210 × 60	Beyaz White	12	\$32,6
	BL-G2-0006	15W	6500 K	1350	210 × 60	Beyaz White	12	\$32,6
	BL-G2-0008	12W	4000 K	1080	175 × 60	Siyah Black	24	\$25,2
	BL-G2-0009	12W	6500 K	1080	175 × 60	Siyah Black	24	\$25,2
	BL-G2-0011	15W	4000 K	1350	210 × 60	Siyah Black	12	\$32,6
	BL-G2-0012	15W	6500 K	1350	210 × 60	Siyah Black	12	\$32,6

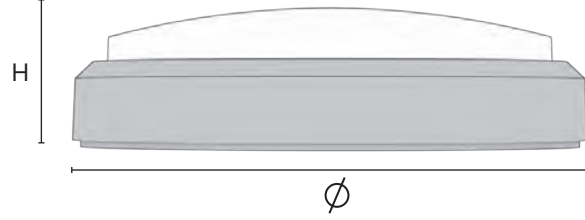

LED NEMLİYER OVAL GLOP TAVAN ARMATÜR

LED NEMLİYER OVAL GLOBE CEILING ARMATURE

Enerji Verimliliği Sınıfı Energy Efficiency Class	Ürün Kodu Product Code	Güç (W) Power	Renk Sıcaklığı (K) Color Temperature	Işık Akısı (Lm) Luminous Flux	Boyutlar (WxLxH) mm Dimensions	Renk Color	Koli Adeti Quantity in Carton	Fiyat Price
	BL-G3-0002	12W	4000 K	1080	100 × 200 × 60	Beyaz White	36	\$23,8
	BL-G3-0003	12W	6500 K	1080	100 × 200 × 60	Beyaz White	36	\$23,8
	BL-G3-0005	15W	4000 K	1350	105 × 230 × 60	Beyaz White	36	\$25,2
	BL-G3-0006	15W	6500 K	1350	105 × 230 × 60	Beyaz White	36	\$25,2
	BL-G3-0008	12W	4000 K	1080	100 × 200 × 60	Siyah Black	36	\$23,8
	BL-G3-0009	12W	6500 K	1080	100 × 200 × 60	Siyah Black	36	\$23,8
	BL-G3-0011	15W	4000 K	1350	105 × 230 × 60	Siyah Black	36	\$25,2
	BL-G3-0012	15W	6500 K	1350	105 × 230 × 60	Siyah Black	36	\$25,2



SENSÖRLÜ LED GLOP LED GLOBE WITH SENSOR

Teknik Özellikler Technical Specifications

Gövde : Polikarbonat (PC)
Body : Polycarbonate

Cam : Polikarbonat
Glass : Polycarbonate

Sensör Tipi : P.I.R Sensör
Sensor Type : P.I.R Sensor

Güç Faktörü : 0.5
Power Factor : 0.5

Renksel Geri Verim : 80
Color Rendering Index : 80

Algılama Mesafesi : 2.5-8 m
Detection Distance : 2.5-8 m



SENSÖRLÜ LED APLİK LED WALL LUMINAIRE WITH SENSOR



LED

3
YIL
GARANTİ

50.000
SAAT

IP54



SENSÖRLÜ GLOP LED

360 derece hareket kızıl ötesi elektronik sensörü ile her yönden algılama ve otomatik aydınlatma. Ürün, gün ışığı algılama sensörü sayesinde gündüz çalışmayıp yalnızca karanlıkta devreye girmektedir. Estetik görünüm ve gözü yormayan soft aydınlatma, siva üstü kolay montaj.

SENSORED GLOP LED

360-degree motion detection and automatic illumination from all directions with an infrared electronic sensor. Thanks to the daylight detection sensor, it does not work during the day and is activated only in the dark. Aesthetic appearance and soft lighting that does not tire the eyes, easy surface mounting.



SENSÖRLÜ LED GLOP

LED GLOBE WITH SENSOR

Enerji Verimliliği Sınıfı Energy Efficiency Class	Ürün Kodu Product Code	Güç (W) Power	Renk Sıcaklığı (K) Color Temperature	Işık Akısı (Lm) Luminous Flux	Boyutlar (ØxH) mm Dimensions	Koli Adeti Quantity in Carton	Fiyat Price
	BL-G4-0001-S	12W	3000 K	960	175 x 55	30	\$26,5
	BL-G4-0002-S	12W	4000 K	960	175 x 55	30	\$26,5
	BL-G4-0003-S	12W	6500 K	960	175 x 55	30	\$26,5
	BL-G4-0004-S	15W	3000 K	1200	175 x 55	30	\$27,0
	BL-G4-0005-S	15W	4000 K	1200	175 x 55	30	\$27,0
	BL-G4-0006-S	15W	6500 K	1200	175 x 55	30	\$27,0

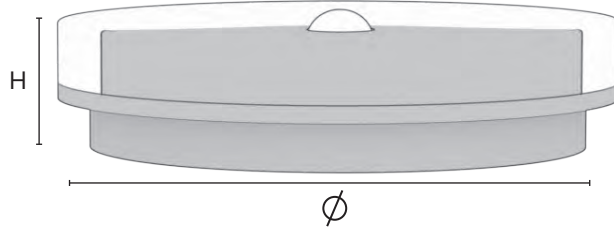

SENSÖRLÜ LED APLİK

LED WALL LUMINAIRE WITH SENSOR

Enerji Verimliliği Sınıfı Energy Efficiency Class	Ürün Kodu Product Code	Güç (W) Power	Renk Sıcaklığı (K) Color Temperature	Işık Akısı (Lm) Luminous Flux	Boyutlar (WxLxH) mm Dimensions	Koli Adeti Quantity in Carton	Fiyat Price
	BL-A1-0001-S	12W	3000 K	960	100 x 200 x 55	30	\$23,4
	BL-A1-0002-S	12W	4000 K	960	100 x 200 x 55	30	\$23,4
	BL-A1-0003-S	12W	6500 K	960	100 x 200 x 55	30	\$23,4
	BL-A1-0004-S	15W	3000 K	1200	100 x 200 x 55	30	\$24,5
	BL-A1-0005-S	15W	4000 K	1200	100 x 200 x 55	30	\$24,5
	BL-A1-0006-S	15W	6500 K	1200	100 x 200 x 55	30	\$24,5

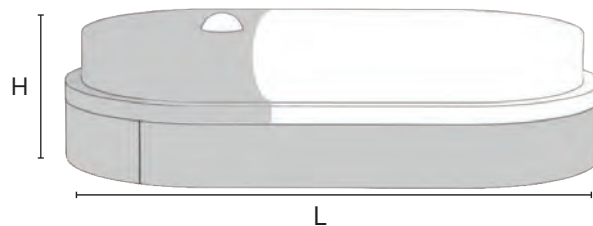

Teknik veri / Datasheet

KARE LED TAVAN GLOP ARMATÜR
KARE LED CEILING GLOBE ARMATURE

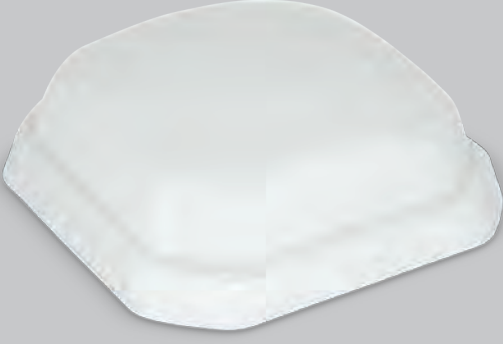

UFO LED TAVAN GLOP ARMATÜR
UFO LED CEILING GLOBE ARMATURE



İNCİ LED TAVAN GLOP ARMATÜR
INCI LED CEILING GLOBE ARMATURE



OKYANUS LED TAVAN GLOP ARMATÜR
OKYANUS LED CEILING GLOBE ARMATURE



Gövde : DKP Sac
Body : DKP Metal Sheet

İSTANBUL LED TAVAN GLOP ARMATÜR
ISTANBUL LED CEILING GLOBE ARMATURE



ASOS LED TAVAN GLOP ARMATÜR
ASOS LED CEILING GLOBE ARMATURE



LED

3
YIL
GARANTİ

50.000
SAAT



Teknik Özellikler Technical Specifications

Gövde : ABS
Body : ABS



Cam : S.A.N.
Glass : S.A.N.

Renkssel Geri Verim : 80
Color Rendering Index : 80



IP Derecesi : IP20
IP Rating : IP20

Sürücü : On-Board
Driver : On-Board



KARE LED TAVAN GLOP ARMATÜR KARE LED CEILING GLOBE ARMATURE

Enerji Verimliliği Sınıfı Energy Efficiency Class	Ürün Kodu Product Code	Güç (W) Power	Renk Sıcaklığı (K) Color Temperature	Işık Akısı (Lm) Luminous Flux	Boyutlar (WxLxH)mm Dimensions	Kutu Adeti Quantity in Box	Koli Adeti Quantity in Carton	Fiyat Price
	BL-B1-0007	12W	6500 K	960	250 × 250 × 93	2	24	\$20,6
	BL-B1-0008	12W	3000 K	960	250 × 250 × 93	2	24	\$20,6

UFO LED TAVAN GLOP ARMATÜR UFO LED CEILING GLOBE ARMATURE

Enerji Verimliliği Sınıfı Energy Efficiency Class	Ürün Kodu Product Code	Güç (W) Power	Renk Sıcaklığı (K) Color Temperature	Işık Akısı (Lm) Luminous Flux	Boyutlar (ØxH) mm Dimensions	Kutu Adeti Quantity in Box	Koli Adeti Quantity in Carton	Fiyat Price
	BL-B1-0009	11W	6500 K	880	222 × 99	2	36	\$17,6
	BL-B1-0010	11W	3000 K	880	222 × 99	2	36	\$17,6

İNCİ LED TAVAN GLOP ARMATÜR INCI LED CEILING GLOBE ARMATURE

Enerji Verimliliği Sınıfı Energy Efficiency Class	Ürün Kodu Product Code	Güç (W) Power	Renk Sıcaklığı (K) Color Temperature	Işık Akısı (Lm) Luminous Flux	Boyutlar (ØxH) mm Dimensions	Kutu Adeti Quantity in Box	Koli Adeti Quantity in Carton	Fiyat Price
	BL-B1-0011	11W	6500 K	880	290 × 90	2	16	\$23,3
	BL-B1-0012	11W	3000 K	880	290 × 90	2	16	\$23,3

OKYANUS LED TAVAN GLOP ARMATÜR OKYANUS LED CEILING GLOBE ARMATURE

Enerji Verimliliği Sınıfı Energy Efficiency Class	Ürün Kodu Product Code	Güç (W) Power	Renk Sıcaklığı (K) Color Temperature	Işık Akısı (Lm) Luminous Flux	Boyutlar (ØxH) mm Dimensions	Kutu Adeti Quantity in Box	Koli Adeti Quantity in Carton	Fiyat Price
	BL-B1-0015	24W	6500 K	1560	345 × 50	2	12	\$25,6
	BL-B1-0016	24W	3000 K	1560	345 × 50	2	12	\$25,6

İSTANBUL LED TAVAN GLOP ARMATÜR İSTANBUL LED CEILING GLOBE ARMATURE

Enerji Verimliliği Sınıfı Energy Efficiency Class	Ürün Kodu Product Code	Güç (W) Power	Renk Sıcaklığı (K) Color Temperature	Işık Akısı (Lm) Luminous Flux	Boyutlar (WxLxH)mm Dimensions	Kutu Adeti Quantity in Box	Koli Adeti Quantity in Carton	Fiyat Price
	BL-B1-0017	24W	6500 K	1920	315 × 275 × 90	2	12	\$26,3
	BL-B1-0018	24W	3000 K	1920	315 × 275 × 90	2	12	\$26,3

ASOS LED TAVAN GLOP ARMATÜR ASOS LED CEILING GLOBE ARMATURE

Enerji Verimliliği Sınıfı Energy Efficiency Class	Ürün Kodu Product Code	Güç (W) Power	Renk Sıcaklığı (K) Color Temperature	Işık Akısı (Lm) Luminous Flux	Boyutlar (WxLxH)mm Dimensions	Kutu Adeti Quantity in Box	Koli Adeti Quantity in Carton	Fiyat Price
	BL-B1-0019	12W	6500 K	960	314 × 214 × 88	2	24	\$23,7
	BL-B1-0020	12W	3000 K	960	314 × 214 × 88	2	24	\$23,7

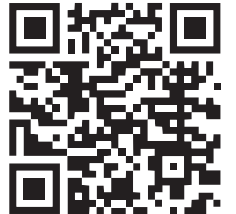

Teknik veri / Datasheet

LED ZÜMRÜT SENSÖRLÜ TAVAN ARMATÜR
LED ZUMRUT CEILING ARMATURE
WITH MOTION SENSOR



LED ZÜMRÜT SENSÖRLÜ TAVAN ARMATÜR + ACIL KIT
LED ZUMRUT CEILING ARMATURE
WITH MOTION SENSOR + EMERGENCY KIT



ZÜMRÜT TAVAN ARMATÜR (2XE27 DUY)
ZUMRUT CEILING ARMATURE



ZÜMRÜT SENSÖRLÜ TAVAN ARMATÜR (2XE27 DUY)
ZUMRUT CEILING ARMATURE WITH MOTION SENSOR



ZÜMRÜT SENSÖRLÜ TAVAN ARMATÜR (2XE27 DUY) + ACIL KIT
ZUMRUT CEILING ARMATURE WITH MOTION SENSOR + EMERGENCY KIT



E27

LED



3
YIL
GARANTİ



Teknik Özellikler Technical Specifications

Gövde DKP Sac
Body : DKP Sheet Metal

IP Derecesi : IP20
IP Rating : IP20

Renksel Geri Verim : 80
Color Rendering Index : 80

Teknik Özellikler Technical Specifications

Gövde DKP Sac
Body : DKP Sheet Metal

IP Derecesi : IP20
IP Rating : IP20

Kullanım : Tasarruflu/
Led Ampul
Usage : Energy Saving/
Led Bulb



LED ZÜMRÜT SENSÖRLÜ TAVAN ARMATÜR LED ZUMRUT CEILING ARMATURE WITH MOTION SENSOR

Enerji Verimliliği Sınıfı Energy Efficiency Class	Ürün Kodu Product Code	Güç (W) Power	Renk Sıcaklığı (K) Color Temperature	Işık Akısı (Lm) Luminous Flux	Boyutlar (WxLxH)mm Dimensions	Koli Adeti Quantity in Carton	Fiyat Price
	BL-B1-0021	15W	6500 K	1300	285 × 100	10	\$24,2
	BL-B1-0022	15W	4000 K	1300	285 × 100	10	\$24,2

LED ZÜMRÜT SENSÖRLÜ TAVAN ARMATÜR + ACIL KİT LED ZUMRUT CEILING ARMATURE WITH MOTION SENSOR + EMERGENCY KIT

Enerji Verimliliği Sınıfı Energy Efficiency Class	Ürün Kodu Product Code	Güç (W) Power	Renk Sıcaklığı (K) Color Temperature	Işık Akısı (Lm) Luminous Flux	Boyutlar (ØxH) mm Dimensions	Koli Adeti Quantity in Carton	Fiyat Price
	BL-B1-0024	15W	6500 K	1300	285 × 100	10	\$34,4
	BL-B1-0025	15W	4000 K	1300	285 × 100	10	\$34,4

ZÜMRÜT TAVAN ARMATÜR (2XE27 DUY) ZUMRUT CEILING ARMATURE

Ürün Kodu Product Code	Renk Color	Boyutlar (ØxH) mm Dimensions	Kutu Adeti Quantity in Box	Koli Adeti Quantity in Carton	Fiyat Price
BR-00243-050	Beyaz	285 × 100	1	10	524,6 TL

ZÜMRÜT SENSÖRLÜ TAVAN ARMATÜR (2XE27 DUY) ZUMRUT CEILING ARMATURE WITH MOTION SENSOR

Ürün Kodu Product Code	Renk Color	Boyutlar (ØxH) mm Dimensions	Kutu Adeti Quantity in Box	Koli Adeti Quantity in Carton	Fiyat Price
BR-10243 050	Beyaz	285 × 100	1	10	582,60 TL

ZÜMRÜT SENSÖRLÜ TAVAN ARMATÜR (2XE27 DUY) + ACIL KİT ZUMRUT CEILING ARMATURE WITH MOTION SENSOR + EMERGENCY KIT

Ürün Kodu Product Code	Renk Color	Boyutlar (ØxH) mm Dimensions	Kutu Adeti Quantity in Box	Koli Adeti Quantity in Carton	Fiyat Price
BR-C0243-050	Beyaz	285 × 100	1	10	985,70 TL

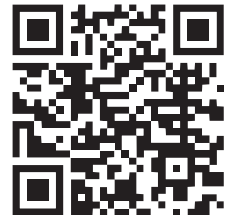

Teknik veri / Datasheet

UFO TAVAN ARMATÜR (1XE27 DUY)
UFO CEILING ARMATURE



UFOLINE TAVAN ARMATÜR (1XE27 DUY)
UFOLINE CEILING ARMATURE



UFOLÜX TAVAN ARMATÜR (1XE27 DUY)
UFOLUX CEILING ARMATURE



GÜNEŞ TAVAN ARMATÜR (1XE27 DUY)
GUNES CEILING ARMATURE

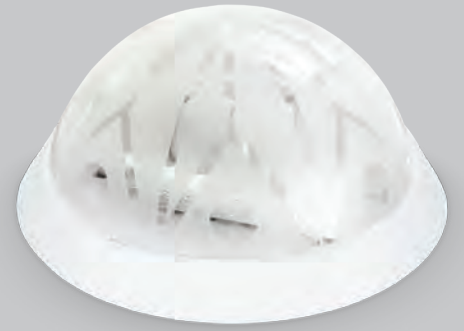

VEGA TAVAN ARMATÜR (1XE27 DUY)
VEGA CEILING ARMATURE

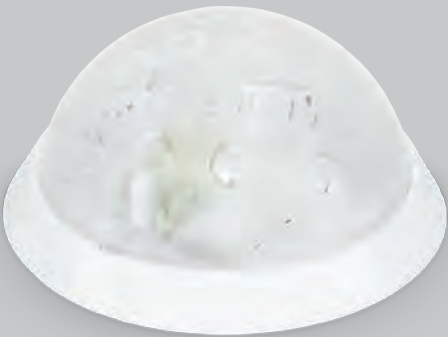

İSİS TAVAN ARMATÜR (1XE27 DUY)
ISIS CEILING ARMATURE



Teknik Özellikler
Technical Specifications

Gövde ABS
Body : ABS

Cam : S.A.N
Glass : S.A.N

Gofraj : Alüminyum
Embossing : Aluminium

IP Derecesi : IP20
IP Rating : IP20

Kullanım : Tasarruflu/
Led Ampul

Usage : Energy Saving/
Led Bulb

UFO TAVAN ARMATÜR (1XE27 DUY)
UFO CEILING ARMATURE

Ürün Kodu Product Code	Renk Color	Boyutlar (ØxH) mm Dimensions	Kutu Adeti Quantity in Box	Koli Adeti Quantity in Carton	Fiyat Price
BR-00203-000	Beyaz	222 × 99	2	36	129,10 TL

UFOLINE TAVAN ARMATÜR (1XE27 DUY)
UFOLINE CEILING ARMATURE

Ürün Kodu Product Code	Renk Color	Boyutlar (ØxH) mm Dimensions	Kutu Adeti Quantity in Box	Koli Adeti Quantity in Carton	Fiyat Price
BR-00248-000	Beyaz	212 × 98	2	36	114,50 TL

UFOLÜX TAVAN ARMATÜR (1XE27 DUY)
UFOLUX CEILING ARMATURE

Ürün Kodu Product Code	Renk Color	Boyutlar (ØxH) mm Dimensions	Kutu Adeti Quantity in Box	Koli Adeti Quantity in Carton	Fiyat Price
BR-00203-010	Beyaz	222 × 99	2	36	134,60 TL

GÜNEŞ TAVAN ARMATÜR (1XE27 DUY)
GUNES CEILING ARMATURE

Ürün Kodu Product Code	Renk Color	Boyutlar (ØxH) mm Dimensions	Kutu Adeti Quantity in Box	Koli Adeti Quantity in Carton	Fiyat Price
BR-00203-020	Beyaz	222 × 99	2	36	131,20 TL

VEGA TAVAN ARMATÜR (1XE27 DUY)
VEGA CEILING ARMATURE

Ürün Kodu Product Code	Renk Color	Boyutlar (ØxH) mm Dimensions	Kutu Adeti Quantity in Box	Koli Adeti Quantity in Carton	Fiyat Price
BR-00248-010	Beyaz	212 × 98	2	36	113,90 TL

İSİS TAVAN ARMATÜR (1XE27 DUY)
ISIS CEILING ARMATURE

Ürün Kodu Product Code	Renk Color	Boyutlar (ØxH) mm Dimensions	Kutu Adeti Quantity in Box	Koli Adeti Quantity in Carton	Fiyat Price
BR-00244-000	Beyaz	214 × 314 × 88	2	24	189,30 TL



Teknik veri / Datasheet

ASOS TAVAN ARMATÜR (1XE27 DUY)
ASOS CEILING ARMATURE

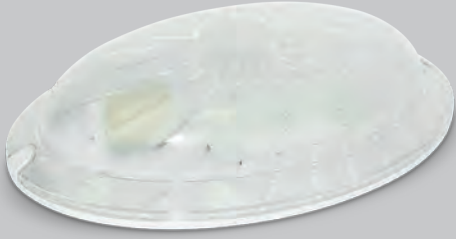

KARE TAVAN ARMATÜR (1XE27 DUY)
KARE CEILING ARMATURE

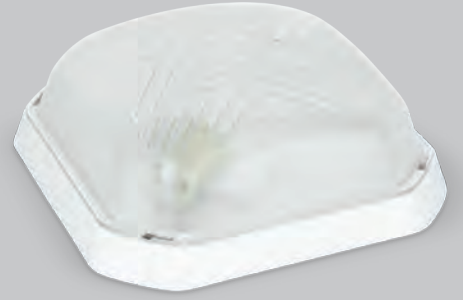

KARE SOFT TAVAN ARMATÜR (1XE27 DUY)
KARE SOFT CEILING ARMATURE



YASMIN TAVAN ARMATÜR (1XE27 DUY)
YASMIN CEILING ARMATURE

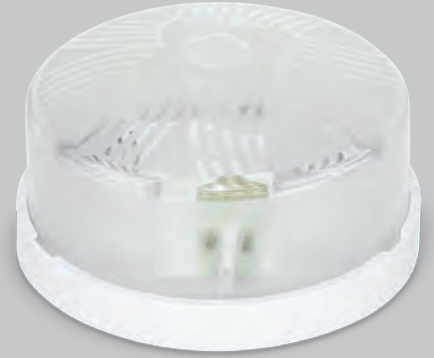

NEPTÜN TAVAN ARMATÜR (1XE27 DUY)
NEPTUN CEILING ARMATURE



VENÜS TAVAN ARMATÜR (1XE27 DUY)
VENUS CEILING ARMATURE



Teknik Özellikler Technical Specifications

Gövde ABS
Body : ABS

Cam : S.A.N
Glass : S.A.N

Gofraj : Alüminyum
Embossing : Aluminium

IP Derecesi : IP20
IP Rating : IP20

Kullanım : Tasarruflu/
Led Ampul
Usage : Energy Saving/
Led Bulb

ASOS TAVAN ARMATÜR (1XE27 DUY)

ASOS CEILING ARMATURE

Ürün Kodu Product Code	Renk Color	Boyutlar (WxLxH) mm Dimensions	Kutu Adeti Quantity in Box	Koli Adeti Quantity in Carton	Fiyat Price
BR-00244-010	Beyaz	214 × 314 × 88	2	24	192 TL

KARE TAVAN ARMATÜR (1XE27 DUY)

KARE CEILING ARMATURE

Ürün Kodu Product Code	Renk Color	Boyutlar (WxLxH) mm Dimensions	Kutu Adeti Quantity in Box	Koli Adeti Quantity in Carton	Fiyat Price
BR-00242-000	Beyaz	250 × 250 × 93	2	24	190,90 TL

KARE SOFT TAVAN ARMATÜR (1XE27 DUY)

KARE SOFT CEILING ARMATURE

Ürün Kodu Product Code	Renk Color	Boyutlar (WxLxH) mm Dimensions	Kutu Adeti Quantity in Box	Koli Adeti Quantity in Carton	Fiyat Price
BR-00242-010	Beyaz	250 × 250 × 93	2	24	190,90 TL

YASMIN TAVAN ARMATÜR (1XE27 DUY)

YASMIN CEILING ARMATURE

Ürün Kodu Product Code	Renk Color	Boyutlar (ØxH) mm Dimensions	Kutu Adeti Quantity in Box	Koli Adeti Quantity in Carton	Fiyat Price
BR-00245-000	Beyaz	220 × 125	2	36	186 TL

NEPTÜN TAVAN ARMATÜR (1XE27 DUY)

NEPTUN CEILING ARMATURE

Ürün Kodu Product Code	Renk Color	Boyutlar (ØxH) mm Dimensions	Kutu Adeti Quantity in Box	Koli Adeti Quantity in Carton	Fiyat Price
BR-00245-010	Beyaz	220 × 125	2	36	196,50 TL

VENÜS TAVAN ARMATÜR (1XE27 DUY)

VENUS CEILING ARMATURE

Ürün Kodu Product Code	Renk Color	Boyutlar (ØxH) mm Dimensions	Kutu Adeti Quantity in Box	Koli Adeti Quantity in Carton	Fiyat Price
BR-00201-000	Beyaz	240 × 100	2	36	202,80 TL



Teknik veri / Datasheet

UZAY TAVAN ARMATÜR (1XE27 DUY)
UZAY CEILING ARMATURE



İSTANBUL TAVAN ARMATÜR (2XE27 DUY)
İSTANBUL CEILING ARMATURE



BOSPHORUS TAVAN ARMATÜR (2XE27 DUY)
BOSPHORUS CEILING ARMATURE

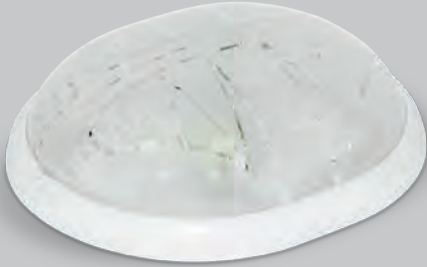

GÖK SOFT TAVAN ARMATÜR (2XE27 DUY)
GOK SOFT CEILING ARMATURE



GÖK SIVA ÜSTÜ TAVAN ARMATÜR (2XE27 DUY)
GOK SURFACE MOUNTED CEILING ARMATURE



OKYANUS TAVAN ARMATÜR (2XE27 DUY)
OKYANUS CEILING ARMATURE

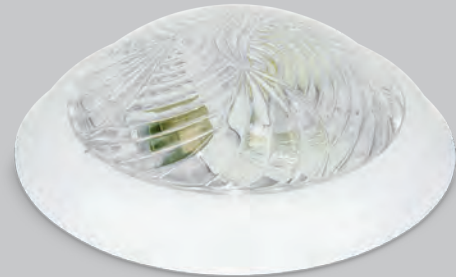

Teknik Özellikler Technical Specifications

Gövde ABS
Body : ABS

Cam : S.A.N
Glass : S.A.N

Gofraj : Alüminyum
Embossing : Aluminium

IP Derecesi : IP20
IP Rating : IP20

Kullanım : Tasarruflu/
Led Ampul
Usage : Energy Saving/
Led Bulb

UZAY TAVAN ARMATÜR (1XE27 DUY)

UZAY CEILING ARMATURE

Ürün Kodu Product Code	Renk Color	Boyutlar (ØxH) mm Dimensions	Kutu Adeti Quantity in Box	Koli Adeti Quantity in Carton	Fiyat Price
BR-00201-010	Beyaz	240 × 97	2	36	202,70 TL

İSTANBUL TAVAN ARMATÜR (2XE27 DUY)

İSTANBUL CEILING ARMATURE

Ürün Kodu Product Code	Renk Color	Boyutlar (WxLxH) mm Dimensions	Kutu Adeti Quantity in Box	Koli Adeti Quantity in Carton	Fiyat Price
BR-00247-000	Beyaz	315 × 275 × 90	2	12	236,20 TL

BOSPHORUS TAVAN ARMATÜR (2XE27 DUY)

BOSPHORUS CEILING ARMATURE

Ürün Kodu Product Code	Renk Color	Boyutlar (WxLxH) mm Dimensions	Kutu Adeti Quantity in Box	Koli Adeti Quantity in Carton	Fiyat Price
BR-00247-010	Beyaz	315 × 275 × 90	2	12	240,30 TL

GÖK SOFT TAVAN ARMATÜR (2XE27 DUY)

GOK SOFT CEILING ARMATURE

Ürün Kodu Product Code	Renk Color	Boyutlar (WxLxH) mm Dimensions	Kutu Adeti Quantity in Box	Koli Adeti Quantity in Carton	Fiyat Price
BR-00230-010	Beyaz	355 × 355 × 97	1	12	457,80 TL

GÖK SIVA ÜSTÜ TAVAN ARMATÜR (2XE27 DUY)

GOK SURFACE MOUNTED CEILING ARMATURE

Ürün Kodu Product Code	Renk Color	Boyutlar (WxLxH) mm Dimensions	Kutu Adeti Quantity in Box	Koli Adeti Quantity in Carton	Fiyat Price
BR-00230-000	Beyaz	355 × 355 × 97	1	12	458,50 TL

OKYANUS TAVAN ARMATÜR (2XE27 DUY)

OKYANUS CEILING ARMATURE

Ürün Kodu Product Code	Renk Color	Boyutlar (ØxH) mm Dimensions	Kutu Adeti Quantity in Box	Koli Adeti Quantity in Carton	Fiyat Price
BR-00231-000	Beyaz	345 × 105	2	12	247,50 TL



Teknik veri / Datasheet

OKYANUS SOFT TAVAN ARMATÜR (2XE27 DUY)
OKYANUS SOFT CEILING ARMATURE



ATLANTİK TAVAN GLOP ARMATÜR (2XE27 DUY)
ATLANTİK CEILING ARMATURE



İNCI TAVAN ARMATÜR (1XE27 DUY)
İNCI CEILING ARMATURE



YAKUT TAVAN ARMATÜR (1XE27 DUY)
YAKUT CEILING ARMATURE



Teknik Özellikler
Technical Specifications

Gövde ABS
Body : ABS

Cam : S.A.N
Glass : S.A.N

Gofraj : Alüminyum
Embossing : Aluminium

IP Derecesi : IP20
IP Rating : IP20

Kullanım : Tasarruflu/
Led Ampul
Usage : Energy Saving/
Led Bulb

Gövde DKP Sac
Body : DKP Sheet Metal

Cam : S.A.N
Glass : S.A.N

Gofraj : Alüminyum
Embossing : Aluminium

IP Derecesi : IP20
IP Rating : IP20

Kullanım : Tasarruflu/
Led Ampul
Usage : Energy Saving/
Led Bulb



Teknik veri / Datasheet

OKYANUS SOFT TAVAN ARMATÜR (2XE27 DUY)
OKYANUS SOFT CEILING ARMATURE

Ürün Kodu Product Code	Renk Color	Boyutlar (ØxH) mm Dimensions	Kutu Adeti Quantity in Box	Koli Adeti Quantity in Carton	Fiyat Price
BR-00231-010	Beyaz	345 × 105	2	12	256 TL

ATLANTIK TAVAN GLOP ARMATÜR (2XE27 DUY)
ATLANTIK CEILING ARMATURE

Ürün Kodu Product Code	Renk Color	Boyutlar (ØxH) mm Dimensions	Kutu Adeti Quantity in Box	Koli Adeti Quantity in Carton	Fiyat Price
BR-00231-020	Beyaz	345 × 105	2	12	263,30 TL

İNCI TAVAN ARMATÜR (1XE27 DUY)
İNCI CEILING ARMATURE

Ürün Kodu Product Code	Renk Color	Boyutlar (ØxH) mm Dimensions	Kutu Adeti Quantity in Box	Koli Adeti Quantity in Carton	Fiyat Price
BR-00206-010	Beyaz	290 × 90	2	16	362,10 TL

YAKUT TAVAN ARMATÜR (1XE27 DUY)
YAKUT CEILING ARMATURE

Ürün Kodu Product Code	Renk Color	Boyutlar (ØxH) mm Dimensions	Kutu Adeti Quantity in Box	Koli Adeti Quantity in Carton	Fiyat Price
BR-00206-000	Beyaz	290 × 90	2	16	371,80 TL

EKOTA LED DUVAR APLİK
EKOTA LED WALL LIGHTING FIXTURE



EKOLIGHT LED DUVAR APLİK
EKOLIGHT LED WALL LIGHTING FIXTURE



NEMLİYER LED DUVAR APLİK IP65
NEMLİYER LED WALL LIGHTING FIXTURE IP65



LED

3 YIL
GARANTİ

50.000
SAAT



Teknik Özellikler Technical Specifications

Gövde : ABS
Body : ABS



Cam : S.A.N
Glass : S.A.N.

Renksel Geri Verim : 80
Color Rendering Index : 80



IP Derecesi : IP20
IP Rating : IP20

Sürücü : On-Board
Driver : On-Board

EKOTA LED DUVAR APLİK EKOTA LED WALL LIGHTING FIXTURE

Enerji Verimliliği Sınıfı Energy Efficiency Class	Ürün Kodu Product Code	Güç (W) Power	Renk Sıcaklığı (K) Color Temperature	Işık Akısı (Lm) Luminous Flux	Boyutlar (WxLxH)mm Dimensions	Kutu Adeti Quantity in Box	Koli Adeti Quantity in Carton	Fiyat Price
	BL-B1-0001	12W	6500 K	960	150 × 260 × 50	2	36	\$15,1
	BL-B1-0002	12W	3000 K	960	150 × 260 × 50	2	36	\$15,1

EKOLIGHT LED DUVAR APLİK EKOLIGHT LED WALL LIGHTING FIXTURE

Enerji Verimliliği Sınıfı Energy Efficiency Class	Ürün Kodu Product Code	Güç (W) Power	Renk Sıcaklığı (K) Color Temperature	Işık Akısı (Lm) Luminous Flux	Boyutlar (WxLxH)mm Dimensions	Kutu Adeti Quantity in Box	Koli Adeti Quantity in Carton	Fiyat Price
	BL-B1-0003	12W	6500 K	960	168 × 276 × 50	2	36	\$15,4
	BL-B1-0004	12W	3000 K	960	168 × 276 × 50	2	36	\$15,4

NEMLİYER LED DUVAR APLİK NEMLİYER LED WALL LIGHTING FIXTURE

Enerji Verimliliği Sınıfı Energy Efficiency Class	Ürün Kodu Product Code	Güç (W) Power	Renk Sıcaklığı (K) Color Temperature	Işık Akısı (Lm) Luminous Flux	Boyutlar (WxLxH)mm Dimensions	Kutu Adeti Quantity in Box	Koli Adeti Quantity in Carton	Fiyat Price
	BL-B1-0005	12W	6500 K	750	135 × 235 × 55	2	36	\$15,9
	BL-B1-0006	12W	3000 K	750	135 × 235 × 55	2	36	\$15,9



Teknik veri / Datasheet

ŞAH DUVAR APLİK ARMATÜR (1XE27 DUY)
SAH WALL LUMINAIRE



IP Derecesi : IP40
IP Rating : IP40

AYNA ÜSTÜ DUVAR APLİK ARMATÜR (2XE14 DUY)
AYNA USTU WALL LUMINAIRE



KRALIÇE DUVAR APLİK ARMATÜR (1XE27 DUY)
KRALICE WALL LUMINAIRE

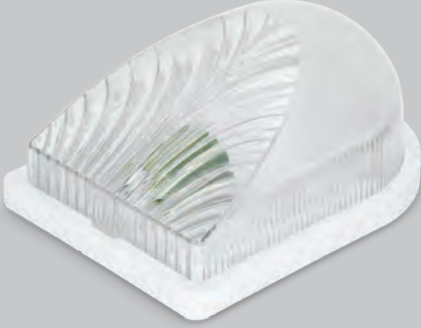

EKOTA DUVAR APLİK ARMATÜR (1XE27 DUY)
EKOTA WALL LUMINAIRE



EKOLIGHT DUVAR APLİK ARMATÜR (1XE27 DUY)
EKOLIGHT WALL LUMINAIRE



EKOSOFT DUVAR APLİK ARMATÜR (1XE27 DUY)
EKOSOFT WALL LUMINAIRE

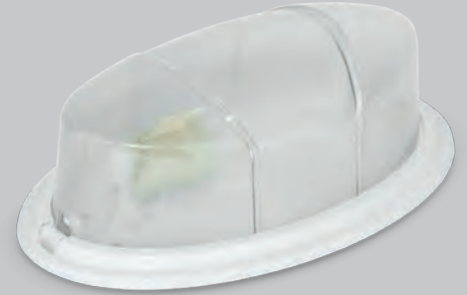

E27

3 YIL
GARANTİ



Teknik Özellikler
Technical Specifications

Gövde ABS
Body : ABS

Cam : S.A.N
Glass : S.A.N

IP Derecesi : IP20
IP Rating : IP20

Kullanım : Tasarruflu/
Led Ampul
Usage : Energy Saving/
Led Bulb

ŞAH DUVAR APLİK ARMATÜR (1XE27 DUY)

ŞAH WALL LUMINAIRE

Ürün Kodu Product Code	Renk Color	Boyutlar (WxLxH) mm Dimensions	Kutu Adeti Quantity in Box	Koli Adeti Quantity in Carton	Fiyat Price
BR-00309-000	Beyaz	150 × 87 × 230	1	48	137,70 TL

AYNA ÜSTÜ DUVAR APLİK ARMATÜR (2XE14 DUY)

AYNA USTU WALL LUMINAIRE

Ürün Kodu Product Code	Renk Color	Boyutlar (WxLxH) mm Dimensions	Kutu Adeti Quantity in Box	Koli Adeti Quantity in Carton	Fiyat Price
BR-00235-000	Beyaz	290 × 85 × 74	1	48	147 TL

KRALIÇE DUVAR APLİK ARMATÜR (1XE27 DUY)

KRALIÇE WALL LUMINAIRE

Ürün Kodu Product Code	Renk Color	Boyutlar (WxLxH) mm Dimensions	Kutu Adeti Quantity in Box	Koli Adeti Quantity in Carton	Fiyat Price
BR-00306-000	Beyaz	166 × 236 × 114	2	36	140,90 TL

EKOTA DUVAR APLİK ARMATÜR (1XE27 DUY)

EKOTA WALL LUMINAIRE

Ürün Kodu Product Code	Renk Color	Boyutlar (WxLxH) mm Dimensions	Kutu Adeti Quantity in Box	Koli Adeti Quantity in Carton	Fiyat Price
BR-00307-000	Beyaz	276 × 168 × 100	2	36	148,10 TL

EKOLIGHT DUVAR APLİK ARMATÜR (1XE27 DUY)

EKOLIGHT WALL LUMINAIRE

Ürün Kodu Product Code	Renk Color	Boyutlar (WxLxH) mm Dimensions	Kutu Adeti Quantity in Box	Koli Adeti Quantity in Carton	Fiyat Price
BR-00246-000	Beyaz	276 × 168 × 100	2	36	160,50 TL

EKOSOFT DUVAR APLİK ARMATÜR (1XE27 DUY)

EKOSOFT WALL LUMINAIRE

Ürün Kodu Product Code	Renk Color	Boyutlar (WxLxH) mm Dimensions	Kutu Adeti Quantity in Box	Koli Adeti Quantity in Carton	Fiyat Price
BR-00246-010	Beyaz	276 × 168 × 100	2	36	158,30 TL



KRAL DEKORATIF DUVAR APLİK ARMATÜR (1XE27 DUY)
KRAL DECORATIVE WALL LUMINAIRE

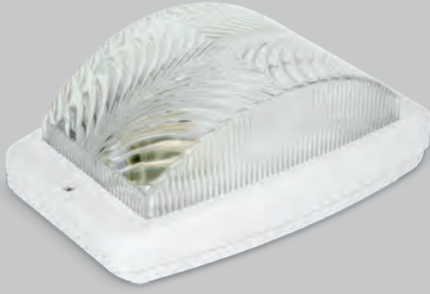

KRAL KAFESLİ DUVAR APLİK ARMATÜR (1XE27 DUY)
KRAL CAGED WALL LUMINAIRE

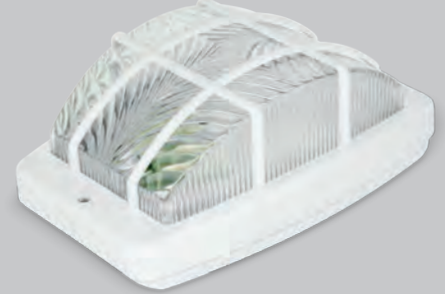

TAÇ DUVAR APLİK ARMATÜR (1XE27 DUY)
TAC WALL LUMINAIRE



PETEK DEKORATIF DUVAR APLİK ARMATÜR (1XE27 DUY)
PETEK DECORATIVE WALL LUMINAIRE

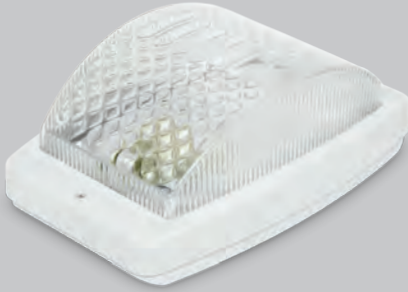

PETEK KAFESLİ DUVAR APLİK ARMATÜR (1XE27 DUY)
PETEK CAGED WALL LUMINAIRE



NEMLİYER DEKORATIF DUVAR APLİK ARMATÜR
NEMLİYER DECORATIVE WALL LUMINAIRE

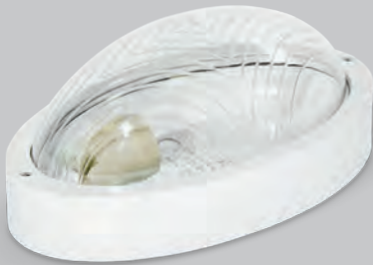

IP65

NEMLİYER KAFESLİ DEKORATIF DUVAR APLİK ARMATÜR
NEMLİYER CAGED WALL LUMINAIRE



IP65



E27

3 YIL GARANTİ



Teknik Özellikler
Technical Specifications

Gövde ABS
Body : ABS

Cam : S.A.N
Glass : S.A.N

IP Derecesi : IP44
IP Rating : IP44

Kullanım : Tasarruflu/
Led Ampul
Usage : Energy Saving/
Led Bulb

KRAL DEKORATİF DUVAR APLİK ARMATÜR (1XE27 DUY)
KRAL DECORATIVE WALL LUMINAIRE

Ürün Kodu Product Code	Renk Color	Boyutlar (WxLxH) mm Dimensions	Kutu Adeti Quantity in Box	Koli Adeti Quantity in Carton	Fiyat Price
BR-00220-000	Beyaz	260 × 165 × 102	1	20	260,60 TL

KRAL KAFESLİ DUVAR APLİK ARMATÜR (1XE27 DUY)
KRAL CAGED WALL LUMINAIRE

Ürün Kodu Product Code	Renk Color	Boyutlar (WxLxH) mm Dimensions	Kutu Adeti Quantity in Box	Koli Adeti Quantity in Carton	Fiyat Price
BR-00220-001	Beyaz	260 × 165 × 110	1	20	271,90 TL

TAÇ DUVAR APLİK ARMATÜR (1XE27 DUY)
TAC WALL LUMINAIRE

Ürün Kodu Product Code	Renk Color	Boyutlar (WxLxH) mm Dimensions	Kutu Adeti Quantity in Box	Koli Adeti Quantity in Carton	Fiyat Price
BR-00249-000	Beyaz	240 × 120 × 120	2	36	81,60 TL

PETEK DEKORATİF DUVAR APLİK ARMATÜR (1XE27 DUY)
PETEK DECORATIVE WALL LUMINAIRE

Ürün Kodu Product Code	Renk Color	Boyutlar (WxLxH) mm Dimensions	Kutu Adeti Quantity in Box	Koli Adeti Quantity in Carton	Fiyat Price
BR-00220-010	Beyaz	260 × 165 × 102	1	20	260 TL

PETEK KAFESLİ DUVAR APLİK ARMATÜR (1XE27 DUY)
PETEK CAGED WALL LUMINAIRE

Ürün Kodu Product Code	Renk Color	Boyutlar (WxLxH) mm Dimensions	Kutu Adeti Quantity in Box	Koli Adeti Quantity in Carton	Fiyat Price
BR-00220-011	Beyaz	260 × 165 × 110	1	20	272,90 TL

NEMLİYER DEKORATİF DUVAR APLİK ARMATÜR (1XE27 DUY)
NEMLİYER DECORATIVE WALL LUMINAIRE

Ürün Kodu Product Code	Renk Color	Boyutlar (WxLxH) mm Dimensions	Kutu Adeti Quantity in Box	Koli Adeti Quantity in Carton	Fiyat Price
BR-00222-000	Beyaz	235 × 135 × 107	1	20	190,30 TL

NEMLİYER KAFESLİ DEKORATİF DUVAR APLİK ARMATÜR (1XE27 DUY)
NEMLİYER CAGED WALL LUMINAIRE

Ürün Kodu Product Code	Renk Color	Boyutlar (ØxH) mm Dimensions	Kutu Adeti Quantity in Box	Koli Adeti Quantity in Carton	Fiyat Price
BR-00222-001	Beyaz	235 × 135 × 120	1	20	203,30 TL



Teknik veri / Datasheet

LED ACİL ÇIKIŞ ARMATÜRÜ

LED EMERGENCY EXIT LUMINAIRE

Teknik Özellikler

Technical Specifications

Gövde : ABS
Body : ABS

Difüzör : Akrilik
Diffuser : Acrylic

IP Derecesi : IP40
IP Rating : IP40

Montaj : Sıva üstü
Mounting : Surface Mounted

Pil Türü : Nikel-Kadmiyum
Battery Type : Ni-Cd

Acilde kullanım : 3 Saat
Emergency Use : 3 Hours



ACİL ÇIKIŞ ARMATÜRÜ

Kalite standartlarına uygun gövde ve difüzör yapısı, LED aydınlatması ve şebeke voltaj dalgalanmalarına karşı Ni-Cd pil direnci ile acil durumlarda kılavuz işaretlemeler için tasarlanmış güvenilir bir armatürdür.

EMERGENCY EXIT LUMINAIRE

It is a reliable luminaire designed for guide markings in emergency conditions with its body and diffuser structure by quality standards, LED lighting and Ni-Cd battery resistance to mains voltage fluctuations.



LED ACİL ÇIKIŞ ARMATÜRÜ

LED EMERGENCY EXIT LUMINAIRE

Ürün Kodu Product Code	Güç (W) Power	Işık Akısı (Lm) Luminous Flux	Giriş Voltajı Input Voltage	Boyutlar (WxLxH) mm Dimensions	Koli Adeti Quantity in Carton	Fiyat Price
BL-AC-0002	3W	120	220-230 V AC	195 × 325 × 55	20	\$54,2

AŞAĞI YÖNLÜ



Ürün Kodu Product Code	Güç (W) Power	Işık Akısı (Lm) Luminous Flux	Giriş Voltajı Input Voltage	Boyutlar (WxLxH) mm Dimensions	Koli Adeti Quantity in Carton	Fiyat Price
BL-AC-0003	3W	120	220-230 V AC	195 × 325 × 55	20	\$54,2

İLERİ YÖNLÜ



Ürün Kodu Product Code	Güç (W) Power	Işık Akısı (Lm) Luminous Flux	Giriş Voltajı Input Voltage	Boyutlar (WxLxH) mm Dimensions	Koli Adeti Quantity in Carton	Fiyat Price
BL-AC-0004	3W	120	220-230 V AC	195 × 325 × 55	20	\$54,2

YUKARI YÖNLÜ



Teknik veri / Datasheet

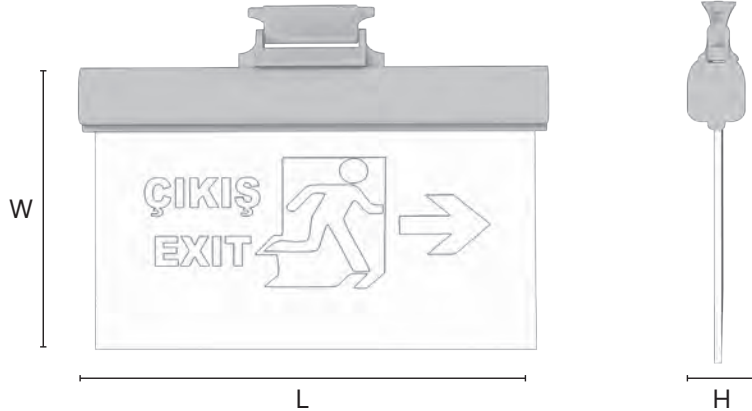

LED ACİL ÇIKIŞ ARMATÜRÜ

LED EMERGENCY EXIT LUMINAIRE

Teknik Özellikler

Technical Specifications

Gövde : Alüminyum
Body : Aluminium

Difüzör : Akrilik
Diffuser : Acrylic

IP Derecesi : IP20
IP Rating : IP20

Montaj : Sıva üstü
Mounting : Surface Mounted

Pil Türü : Nikel-Kadmiyum
Battery Type : Ni-Cd

Acilde kullanım : 3 Saat
Emergency Use : 3 Hours



LED

3
YIL
GARANTİ

50.000
SAAT

ACİL ÇIKIŞ ARMATÜRÜ

Kalite standartlarına uygun gövde ve difüzör yapısı, LED aydınlatması ve şebeke voltaj dalgalanmalarına karşı Ni-Cd pil direnci ile acil durumlarda kılavuz işaretlemeler için tasarlanmış güvenilir bir armatürdür.

EMERGENCY EXIT LUMINAIRE

It is a reliable luminaire designed for guide markings in emergency conditions with its body and diffuser structure by quality standards, LED lighting and Ni-Cd battery resistance to mains voltage fluctuations.



LED ACİL ÇIKIŞ ARMATÜRÜ

LED EMERGENCY EXIT LUMINAIRE

Ürün Kodu Product Code	Ürün Görseli Product Image	Güç (W) Power	Işık Akısı (Lm) Luminous Flux	Giriş Voltajı Input Voltage	Boyutlar (WxLxH) mm Dimensions	Koli Adeti Quantity in Carton	Fiyat Price
BL-AC-0005		3W	120	220-230 V AC	155 × 325 × 22	20	\$16,50
BL-AC-0006		3W	120	220-230 V AC	155 × 325 × 22	20	\$16,50
BL-AC-0007		3W	120	220-230 V AC	155 × 325 × 22	20	\$16,50
BL-AC-0008		3W	120	220-230 V AC	155 × 325 × 22	20	\$16,50
BL-AC-0009		3W	120	220-230 V AC	155 × 325 × 22	20	\$16,50
BL-AC-0010		3W	120	220-230 V AC	155 × 325 × 22	20	\$16,50

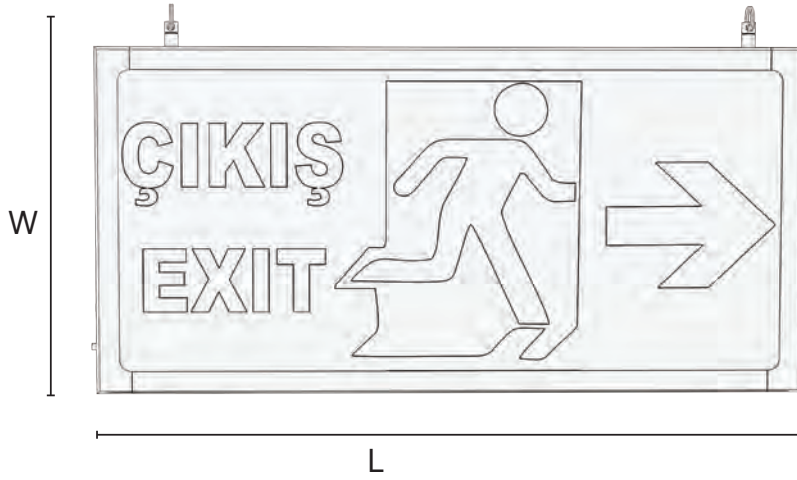

DEDEKTÖR VE SENSÖRLER DETECTOR AND SENSORS

Teknik Özellikler Technical Specifications

Gövde : ABS
Body : ABS

Gövde Renkleri : Beyaz
Body Colors : White

Kapak : ABS
Cover : ABS

Kapak Rengi : Beyaz
Cover Color : White

IIK Derecesi : IK07
IK Rating : IK07

Çalışma Sıcaklığı : -20 C / 45 C
Operating Temp. Range : -20 C / 45 C

Çalışma Gerilimi : 220-240 V AC
Operating Voltage Range : 220-240 V AC

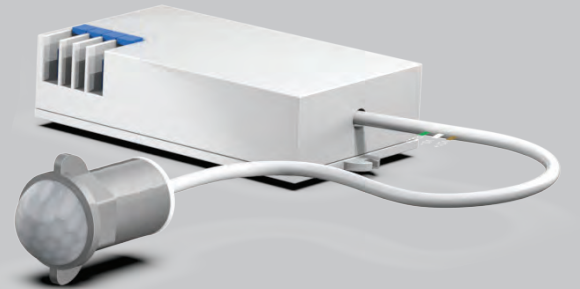

DEDEKTÖR VE SENSÖRLER

Ev ve iş yerlerinde yangın emniyeti, genel amaçlı güvenlik unsurları ve otomatik aydınlatma fonksiyonları ile enerji tasarrufu için tercih edilen ürünlerdir. Sensör, belirli dış uyarımları algılayan ve ayırt edici bir şekilde yanıt veren bir cihazdır. Dedektör, belirli bir maddeyi veya fiziksel fenomeni kaydedebilen bir cihazdır.

DETECTOR AND SENSORS

They are the products preferred for energy saving with fire safety, general-purpose security elements and automatic lighting functions in homes and workplaces. A sensor is a device that detects certain external stimuli and responds in a distinctive way. A detector is a device that can record a particular substance or physical phenomenon.



DUMAN DEDEKTÖRÜ SMOKE DETECTOR

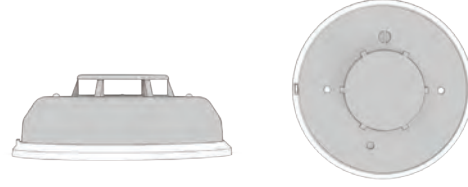

Ürün Kodu Product Code	Çalışma Gerilimi Operating Voltage	Siren Şiddeti Siren Intensity	Montaj Yüksekliği Mounting Height	Çalışma Sıcaklığı Operating Temp.	Koli Adeti Quantity in Carton	Fiyat Price
BR-DD001	9V DC	80dB	3m	-10°C - +50°C	100	\$17

MİNİ SENSÖR MINI SENSOR

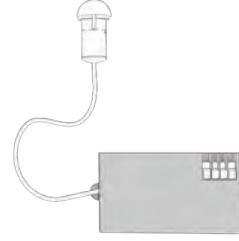

Ürün Kodu Product Code	Güç (W) Power	Akım Flow	Montaj Yüksekliği Mounting Height	Çalışma Sıcaklığı Operating Temp.	Algılama Mesafesi Detection Distance	Giriş Voltajı Input Voltage	Frekans Frequency	Koli Adeti Quantity in Carton	Fiyat Price
BR-MS001	1200W	Max 10 A	2.2 - 4m	-10°C - +40°C	Max 8m	220-240	50-60Hz	200	\$13,4

SIVA ALTI 360° SENSÖR FLUSH MOUNTED 360° SENSOR

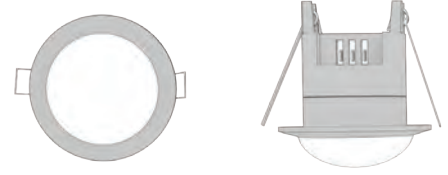

Ürün Kodu Product Code	Giriş Voltajı Input Voltage	Frekans Frequency	Montaj Yüksekliği Mounting Height	Çalışma Sıcaklığı Operating Temp.	Anma Yüğü Rated Load	Algılama Derecesi Detection Degree	Algılama Mesafesi Detection Distance	Koli Adeti Quantity in Carton	Fiyat Price
BR-SA360	220-240V AC	50Hz	2.5 - 3.5 m	-20°C - +40°C	"Max 1200W Tungsten Max 300W Florasan"	360°	Max 6m	100	\$11,9

SIVA ÜSTÜ 360° SENSÖR SURFACE MOUNTED 360° SENSOR



Ürün Kodu Product Code	Giriş Voltajı Input Voltage	Frekans Frequency	Montaj Yüksekliği Mounting Height	Çalışma Sıcaklığı Operating Temp.	Anma Yüğü Rated Load	Algılama Derecesi Detection Degree	Algılama Mesafesi Detection Distance	Koli Adeti Quantity in Carton	Fiyat Price
BR-SU360	220-240V AC	50Hz	2.2 - 4 m	-20°C - +40°C	Max 1200W Tungsten Max 300W Florasan"	360°	Max 8m	100	\$11,2

RADAR SENSÖR RADAR SENSOR

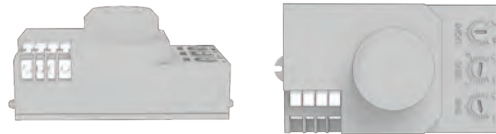

Ürün Kodu Product Code	Güç (W) Power	Akım Flow	Koruma Sınıfı Protection Class	Algılama Mesafesi Detection Distance	Giriş Voltajı Input Voltage	Frekans Frequency	Koli Adeti Quantity in Carton	Fiyat Price
BR-RS001	1200W	10A	IP20	2-8m	220-240	50-60Hz	200	\$14,1



SLİM ACİL AYDINLATMA KİTİ SLIM EMERGENCY LIGHTING KIT



Teknik Özellikler Technical Specifications

Gövde : ABS
Body : ABS

Cam: Polikarbon Cam
Glass: Polycarbon Glass

Giriş Gerilimi : 220-240 V AC
Input Voltage: 220-240 V AC

Çıkış Gerilimi : 3-150 V DC
Output Voltage : 3-150 V DC

Çalışma Frekansı : 50/60 Hz
Operating Frequency : 50/60 Hz

Pil Tipi : Li-Ion
Battery Type : Li-Ion

Pil Kapasitesi : 2500 mA
Battery Capacity: 2500 mA

Şarj Süresi : 24 saat
Charging Time : 24 hours

IP Derecesi : IP20
IP Rating : IP20

Çalışma Sıcaklığı : -20°C / 55°C
Operating Temperature Range : -20°C / 55°C

KOMPAKT ACİL AYDINLATMA KİTİ COMPACT EMERGENCY LIGHTING KIT



ACİL AYDINLATMA KİTİ

Bu acil durum dönüştürme kitleri, 3 saatlik acil durum çözümleri gerektiren çeşitli ürünlerle eşleştirilmek üzere tasarlanmıştır.

EMERGENCY LIGHTING KIT

These emergency conversion kits are designed to be paired with a variety of products that require 3-hour emergency solutions.



SLİM ACİL AYDINLATMA KİTİ

SLIM EMERGENCY LIGHTING KIT

Ürün Kodu Product Code	Güç (W) Power	Çıkış Akımı (max) Color Temperature	Çalışma Süresi (max) Operation Time	Bağlantı Tipi Connection Type	Boyutlar (WxLxH) mm Dimensions	Koli Adeti Quantity in Carton	Fiyat Price
132-1453	50W	<30mA	3 saat 3 hours	Klemens Terminal	31 X 210 X 25	50	\$24,3

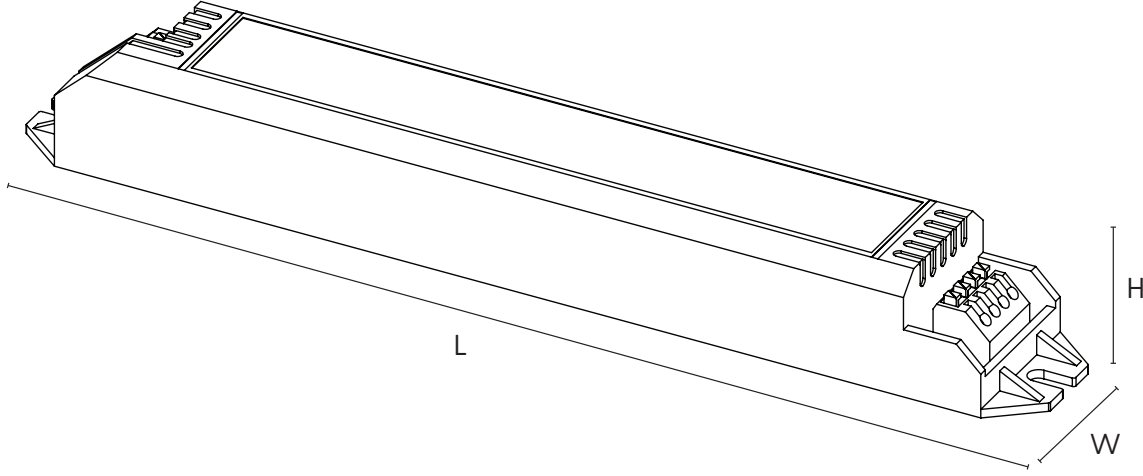

KOMPAKT ACİL AYDINLATMA KİTİ

COMPACT EMERGENCY LIGHTING KIT

Ürün Kodu Product Code	Güç (W) Power	Çıkış Akımı (max) Color Temperature	Çalışma Süresi (max) Operation Time	Bağlantı Tipi Connection Type	Boyutlar (WxLxH) mm Dimensions	Koli Adeti Quantity in Carton	Fiyat Price
132-1454	50W	<30mA	3 saat 3 hours	Dişi/Erkek Konnektör Female/Male Connector	42 X 110 X 25	50	\$23,1

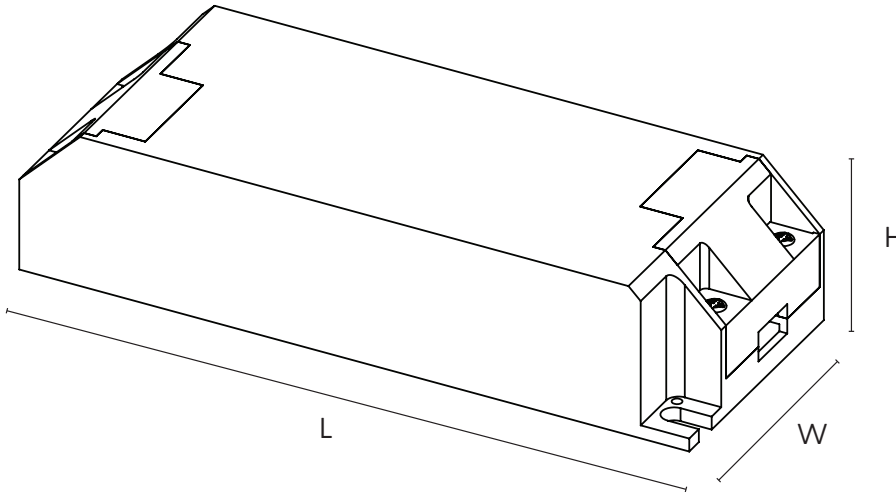

ŞERİT LED LED STRIP

Teknik Özellikler Technical Specifications

Şerit Led
Led Strip

Çalışma Gerilimi : 12 V DC
Operating Voltage Range : 12 V DC

IP Derecesi : IP20
IP Rating : IP20

IK Derecesi : IK07
IK Rating : IK07

Çalışma Sıcaklığı : -20 C / 45 C
Operating Temp. Range : -20 C / 45 C



NEON ŞERİT LED NEON LED STRIP

Teknik Özellikler Technical Specifications

Neon Şerit Led
Neon Led Strip

Çalışma Gerilimi : 220-240 V AC
Operating Voltage Range : 220-240 V AC

IP Derecesi : IP65
IP Rating : IP65

IK Derecesi : IK07
IK Rating : IK07

Çalışma Sıcaklığı : -20 C / 45 C
Operating Temp. Range : -20 C / 45 C



ŞERİT LED

Geleneksel aydınlatma ürünlerine göre düşük güç kullanımı ve yüksek aydınlatma kalitesi, uzun ömürlü ve daha az ısı üretimi ile yüksek verimlilik. Mimari projelerden kişisel tercihlere kadar her türlü ahşap, metal, seramik, cam, duvar vb. yüzeylerde geniş bir kullanım yelpazesi sunar.

NEON ŞERİT LED

Yumuşak, esnek ve ışık geçirgen dış materyal. İç ve dış aydınlatma için maksimum konfor ve ışık verimliliği sunar. Düşük enerji tüketimi ve çevre dostu yapısı ile estetik bir aydınlatma sağlar.

LED STRIP

Compared to traditional lighting products, low power usage and high lighting quality, long life and high efficiency with less heat generation. All kinds of wood, metal, ceramic, glass, wall, etc., from architectural projects to personal preferences. It offers a wide range of uses on surfaces.







NEON LED STRIP

Soft, flexible and transparent outer material. It offers maximum comfort and light efficiency for interior and exterior lighting. It provides aesthetic lighting with its low energy consumption and environmentally friendly structure.



ŞERİT LED (4040)

LED STRIP (4040)

Enerji Verimliliği Sınıfı Energy Efficiency Class	Ürün Kodu Product Code	Renk Color	Güç (W/Mt) Power	Gerilim (V) Voltage (V)	Işık Akısı (Lm/Mt) Luminous Flux	Çip Sayısı Number of Chips	Koli Miktarı (Mt) Box Amount	Fiyat Price
	BL-SL-1001	3000 K	8	12V	900	60	250 Mt	\$1,3
	BL-SL-1002	6500 K	8	12V	900	60	250 Mt	\$1,3
	BL-SL-1003	Mavi	8	12V	120	60	250 Mt	\$1,3
	BL-SL-1004	Yeşil	8	12V	120	60	250 Mt	\$1,3
	BL-SL-1005	Amber	8	12V	120	60	250 Mt	\$1,3
	BL-SL-1006	4000 K	8	12V	900	60	250 Mt	\$1,3

NEON ŞERİT LED

NEON LED STRIP

Enerji Verimliliği Sınıfı Energy Efficiency Class	Ürün Kodu Product Code	Renk Color	Işık Akısı (Lm/Mt) Luminous Flux	Giriş Voltajı Input Voltage	IP Derecesi IP Rating	Koli Miktarı (Mt) Box Amount	Fiyat Price
	BL-NL-1001	3000 K	130	220-240 V AC	IP65	25 Mt	\$5,6
	BL-NL-1002	4000 K	130	220-240 V AC	IP65	25 Mt	\$5,6
	BL-NL-1003	6500 K	130	220-240 V AC	IP65	25 Mt	\$5,6
	BL-NL-1004	KIRMIZI	10	220-240 V AC	IP65	25 Mt	\$5,6
	BL-NL-1005	MAVİ	18	220-240 V AC	IP65	25 Mt	\$5,6
	BL-NL-1006	YEŞİL	30	220-240 V AC	IP65	25 Mt	\$5,6
	BL-NL-1007	AMBER	85	220-240 V AC	IP65	25 Mt	\$5,6
	BL-NL-1008	RGB	10	220-240 V AC	IP65	25 Mt	\$7,9

AKSESUARLAR

ACCESSORIES

Ürün Kodu Product Code	Ürün Adı Product Name	Koli Adedi Quantity in Carton	Fiyat Price
134-2001	220-240 V AC NEON BAĞLANTI APARATI	1	\$1,50
134-2009	220-240 V AC NEON BAĞLANTI APARATI RGB KUMANDA SETİ	1	\$2,50
134-2005	NEON KROŞE	1	\$0,04
134-2006	NEON KROŞE RGB	1	\$0,04
134-2007	NEON UÇ KAPAĞI	1	\$0,03
134-2008	NEON UÇ KAPAĞI RGB	1	\$0,03



Teknik veri / Datasheet

ŞERİT LED TRAFOLARI LED STRIP TRANSFORMERS

Teknik Özellikler Technical Specifications

Gövde : Alüminyum
Body : Aluminium

Gövde Renkleri : Metalik
Body Colors : Metallic

Kapak : Alüminyum
Cover : Aluminium

Kapak Rengi : Metalik
Cover Color : Metallic

Çalışma Gerilimi : 220-240 V AC
Operating Voltage Range : 220-240 V AC

IP Derecesi : IP20
IP Rating : IP20

IK Derecesi : IK08
IK Rating : IK08

Çalışma Sıcaklığı : -20 C / 45 C
Operating Temp. Range : -20 C / 45 C



ŞERİT LED TRAFOLARI

Neon ve şerit ledlere bağlanan çalışma mekanizmasına led trafo denir. Güvenilir ve verimli bir aydınlatma sistemi için doğru elektriksel kapasiteler ve işlevsel özellikler sağlanması önemlidir.

LED STRIP TRANSFORMERS

The operating mechanism connected to neon and strip LED's is called a led transformer. Providing the correct electrical capacities and functional properties is essential for a reliable and efficient lighting system.



ŞERİT LED TRAFOLARI LED STRIP TRANSFORMERS

Ürün Kodu Product Code	Güç Power	Gerilim (V) Voltage (V)	Akım (A) Current (A)	Boyutlar (WxLxH) mm Dimensions	Gövde Malzemesi Body Material	Koli Adeti Quantity in Carton	Fiyat Price
BL-T1-132-1599	60W	12V	5A	40 × 160 × 32	Alüminyum	50	\$11,9
BL-T1-132-1600	120W	12V	10A	46 × 190 × 37	Alüminyum	40	\$15,8
BL-T1-132-1601	150W	12V	12,5A	58 × 200 × 40	Alüminyum	40	\$21,2
BL-T1-132-1602	200W	12V	16,5A	58 × 200 × 40	Alüminyum	40	\$25,6
BL-T1-132-1603	250W	12V	20A	68 × 225 × 40	Alüminyum	32	\$28,4
BL-T1-132-1604	360W	12V	30A	68 × 225 × 42	Alüminyum	32	\$34,4

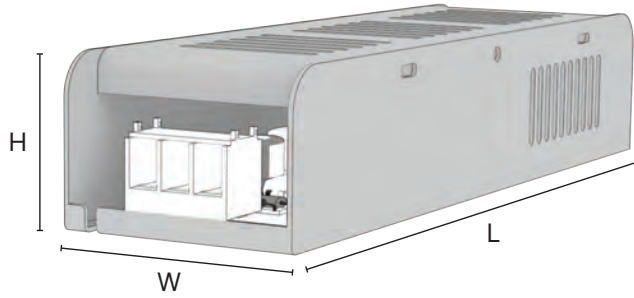

SIVA ALTI ve SIVA ÜSTÜ HALOJEN FREE SİGORTA KUTULARI RECESSED AND SURFACE MOUNTED HALOGEN FREE FUSE BOXES

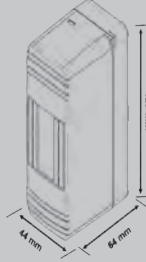

2'li Mühürlü Sigorta Kutusu

2 Module Distribution Box - Sealed

Ürün Kodu Product Code	Kutu Adedi Quantity in Box	Koli Adedi Quantity in Carton	Fiyat Price
BR-818	1	98	33 TL

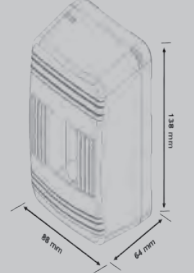

4'lü Mühürlü Sigorta Kutusu

4 Module Distribution Box - Sealed

Ürün Kodu Product Code	Kutu Adedi Quantity in Box	Koli Adedi Quantity in Carton	Fiyat Price
BR-819	1	50	53,80 TL

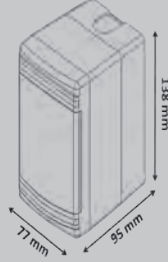

2'li Sıva Üstü Sigorta Kutusu

2 Module Distribution Box - Surface Mounted

Ürün Kodu Product Code	Kutu Adedi Quantity in Box	Koli Adedi Quantity in Carton	Fiyat Price
BR-820	2	40	110,50 TL

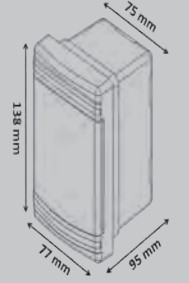

2'li Sıva Altı Sigorta Kutusu

2 Module Distribution Box - Recessed

Ürün Kodu Product Code	Kutu Adedi Quantity in Box	Koli Adedi Quantity in Carton	Fiyat Price
BR-821	2	40	100,10 TL

SIVA ALTI ve SIVA ÜSTÜ HALOJEN FREE SİGORTA KUTULARI

Standartlara uygun olarak üretilen sıva altı ve sıva üstü sigorta kutularımız Halojensiz (alev yaymayan) özelliklere sahiptir. Isıya ve darbelere dayanıklı gövdesi, geniş iç hacmi ve şeffaf yaylı kapak özellikleri ile evinizde ve iş yerinizde güvenle kullanabilirsiniz.

RECESSED AND SURFACE MOUNTED HALOGEN FREE FUSE BOXES

Our flush-mounted and surface-mounted fuse boxes, produced by the standards, have Halogen-free (non-flame-emitting) features. You can use it safely in your home and workplace with its heat and impact resistant body, large interior volume and transparent spring cover features.



SIVA ALTI ve SIVA ÜSTÜ HALOJEN FREE SİGORTA KUTULARI RECESSED AND SURFACE MOUNTED HALOGEN FREE FUSE BOXES

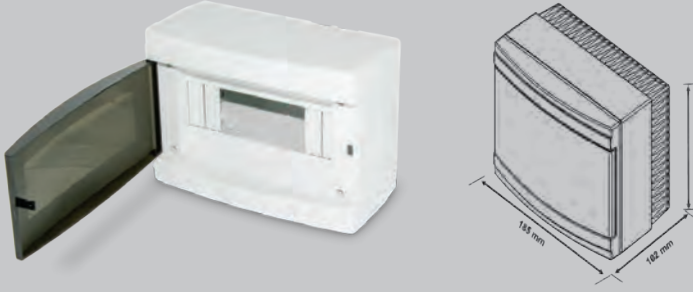

6'lı Siva Üstü Sigorta Kutusu
6 Module Distribution Box - Surface Mounted

Ürün Kodu Product Code	Kutu Adedi Quantity in Box	Koli Adedi Quantity in Carton	Fiyat Price
BR-804	1	30	188,30 TL

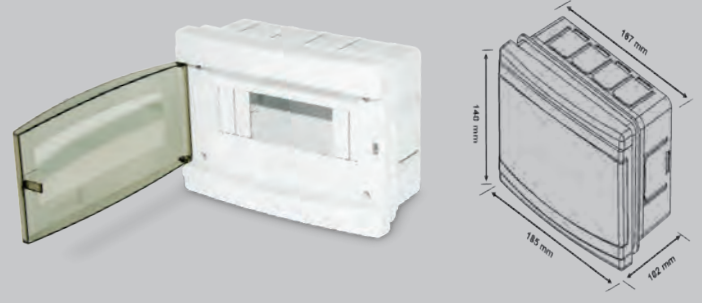

6'lı Siva Altı Sigorta Kutusu
6 Module Distribution Box - Recessed

Ürün Kodu Product Code	Kutu Adedi Quantity in Box	Koli Adedi Quantity in Carton	Fiyat Price
BR-803	1	30	160 TL

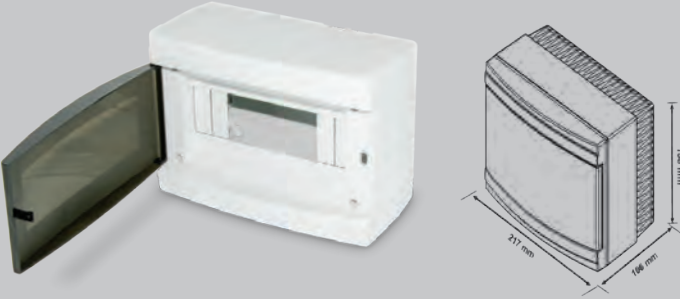

9'lı Siva Üstü Sigorta Kutusu
9 Module Distribution Box - Surface Mounted

Ürün Kodu Product Code	Kutu Adedi Quantity in Box	Koli Adedi Quantity in Carton	Fiyat Price
BR-806	1	20	242,50 TL

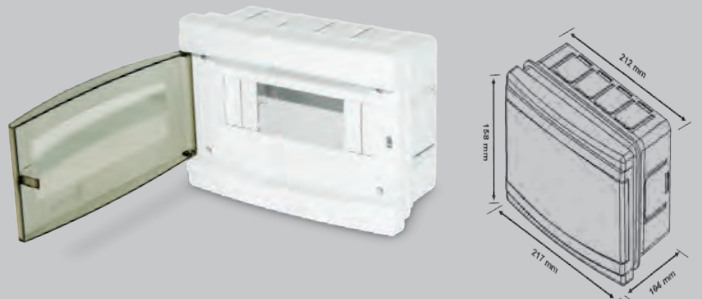

9'lı Siva Altı Sigorta Kutusu
9 Module Distribution Box - Recessed

Ürün Kodu Product Code	Kutu Adedi Quantity in Box	Koli Adedi Quantity in Carton	Fiyat Price
BR-805	1	20	208,70 TL



12'li Siva Üstü Sigorta Kutusu
12 Module Distribution Box - Surface Mounted

Ürün Kodu Product Code	Kutu Adedi Quantity in Box	Koli Adedi Quantity in Carton	Fiyat Price
BR-808	1	20	318,90 TL



12'li Siva Altı Sigorta Kutusu
12 Module Distribution Box - Recessed

Ürün Kodu Product Code	Kutu Adedi Quantity in Box	Koli Adedi Quantity in Carton	Fiyat Price
BR-807	1	20	280,60 TL



SIVA ALTI ve SIVA ÜSTÜ HALOJEN FREE SİGORTA KUTULARI RECESSED AND SURFACE MOUNTED HALOGEN FREE FUSE BOXES



16'li Siva Üstü Sigorta Kutusu
16 Module Distribution Box - Surface Mounted

Ürün Kodu Product Code	Kutu Adedi Quantity in Box	Koli Adedi Quantity in Carton	Fiyat Price
BR-816	1	10	426,30 TL

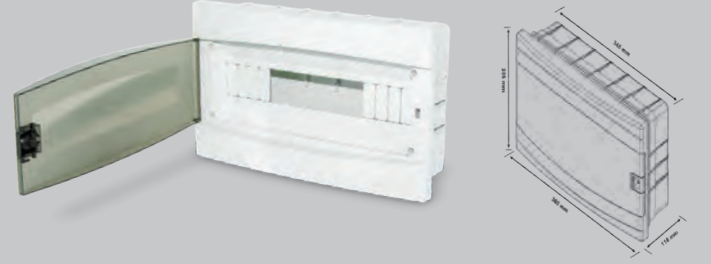

16'li Siva Altı Sigorta Kutusu
16 Module Distribution Box - Recessed

Ürün Kodu Product Code	Kutu Adedi Quantity in Box	Koli Adedi Quantity in Carton	Fiyat Price
BR-815	1	10	394,50 TL



18'li Siva Üstü Sigorta Kutusu
18 Module Distribution Box - Surface Mounted

Ürün Kodu Product Code	Kutu Adedi Quantity in Box	Koli Adedi Quantity in Carton	Fiyat Price
BR-814	1	10	456,80 TL

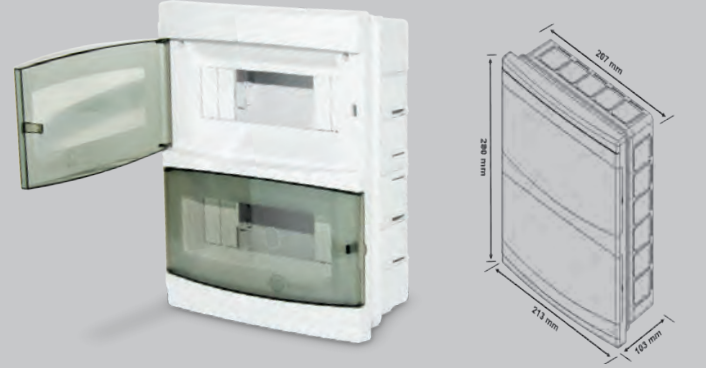

18'li Siva Altı Sigorta Kutusu
18 Module Distribution Box - Recessed

Ürün Kodu Product Code	Kutu Adedi Quantity in Box	Koli Adedi Quantity in Carton	Fiyat Price
BR-813	1	10	414,90 TL

SIVA ALTI ve SIVA ÜSTÜ HALOJEN FREE SİGORTA KUTULARI

Standartlara uygun olarak üretilen siva altı ve siva üstü sigorta kutularımız Halojensiz (alev yaymayan) özelliklere sahiptir. Isıya ve darbelere dayanıklı gövdesi, geniş iç hacmi ve şeffaf yaylı kapak özellikleri ile evinizde ve iş yerinizde güvenle kullanabilirsiniz.

RECESSED AND SURFACE MOUNTED HALOGEN FREE FUSE BOXES

Our flush-mounted and surface-mounted fuse boxes, produced by the standards, have Halogen-free (non-flame-emitting) features. You can use it safely in your home and workplace with its heat and impact resistant body, large interior volume and transparent spring cover features.



SIVA ALTI ve SIVA ÜSTÜ HALOJEN FREE SİGORTA KUTULARI RECESSED AND SURFACE MOUNTED HALOGEN FREE FUSE BOXES



24'lü Sıva Üstü Sigorta Kutusu
24 Module Distribution Box - Surface Mounted

Ürün Kodu Product Code	Kutu Adedi Quantity in Box	Koli Adedi Quantity in Carton	Fiyat Price
BR-810	1	10	487,30 TL

24'lü Sıva Altı Sigorta Kutusu
24 Module Distribution Box - Recessed

Ürün Kodu Product Code	Kutu Adedi Quantity in Box	Koli Adedi Quantity in Carton	Fiyat Price
BR-809	1	10	435,30 TL

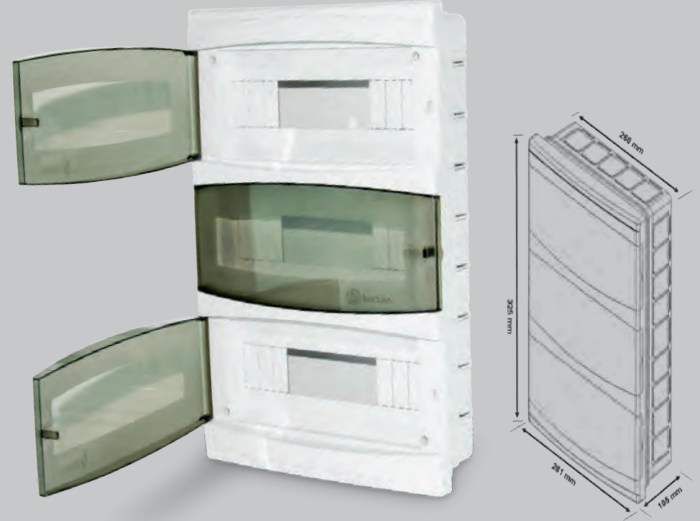

36'lü Sıva Üstü Sigorta Kutusu
36 Module Distribution Box - Surface Mounted

Ürün Kodu Product Code	Kutu Adedi Quantity in Box	Koli Adedi Quantity in Carton	Fiyat Price
BR-812	1	5	684,70 TL

36'lü Sıva Altı Sigorta Kutusu
36 Module Distribution Box - Recessed

Ürün Kodu Product Code	Kutu Adedi Quantity in Box	Koli Adedi Quantity in Carton	Fiyat Price
BR-811	1	5	631,40 TL



SIVA ALTI SAC TABANLI SİGORTA KUTUSU (PLASTİK KAPAKLI) FUSE BOX WITH SHEET BASED (PLASTIC COVER)

Teknik Özellikler Technical Specifications

Gövde : DKP
Body : DKP

Gövde Renkleri : Gri
Body Colors : Grey

Kapak : ABS
Cover : ABS

Kapak Rengi : Beyaz
Cover Color : White

Cam : S.A.N
Glass : S.A.N

IP Derecesi : IP20
IP Rating : IP20

IK Derecesi : IK06
IK Rating : IK06



SIVA ALTI SAC TABANLI ZAYIF AKIM KUTULARI WEAK CURRENT BOXES WITH FLUSH SHEET BASED

Teknik Özellikler Technical Specifications

Gövde : DKP
Body : DKP

Gövde Renkleri : Gri
Body Colors : Grey

Kapak : DKP
Cover : DKP

Kapak Rengi : Gri
Cover Color : Grey

IK Derecesi : IK08
IK Rating : IK08



SIVA ALTI SAC TABANLI SİĞORTA KUTUSU (PLASTİK KAPAKLI) FUSE BOX WITH SHEET BASED (PLASTIC COVER)

Ürün Kodu Product Code	Ürün Adı Product Name	Boyutlar (WxLxH) mm Dimensions	Kutu Adedi Quantity in Box	Koli Adedi Quantity in Carton	Fiyat Price
BR-850	16'lı Sıva Altı Sigorta Kutusu 16 Module Distribution Box - Recessed	116 × 365 × 225	1	10	\$25,50
BR-851	24'lü Sıva Altı Sigorta Kutusu 24 Module Distribution Box - Recessed	105 × 281 × 325	1	10	\$28,70

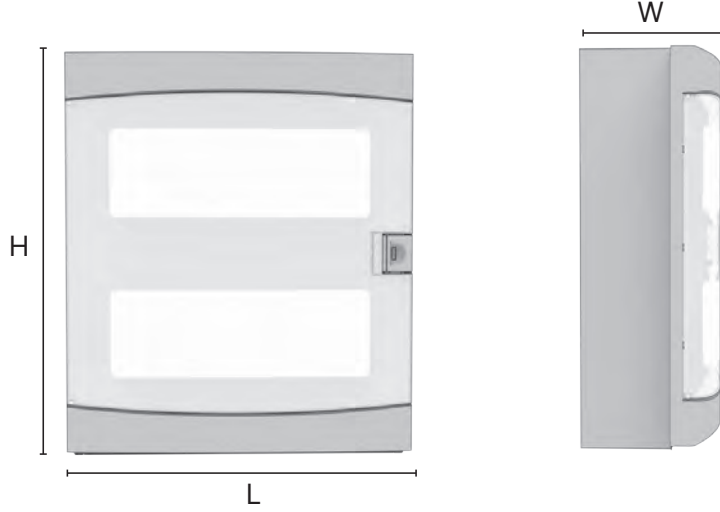

SIVA ALTI SAC TABANLI ZAYIF AKIM KUTULARI WEAK CURRENT BOXES WITH FLUSH SHEET BASED

Ürün Kodu Product Code	Ürün Adı Product Name	Boyutlar (WxLxH) mm Dimensions	Koli Adedi Quantity in Carton	Fiyat Price
BR-860	24'lü Sıva Altı Sac Zayıf Akım Kutusu 24 Flush Mounted Sheet Weak Current Box	115 × 315 × 515	1	\$89,20

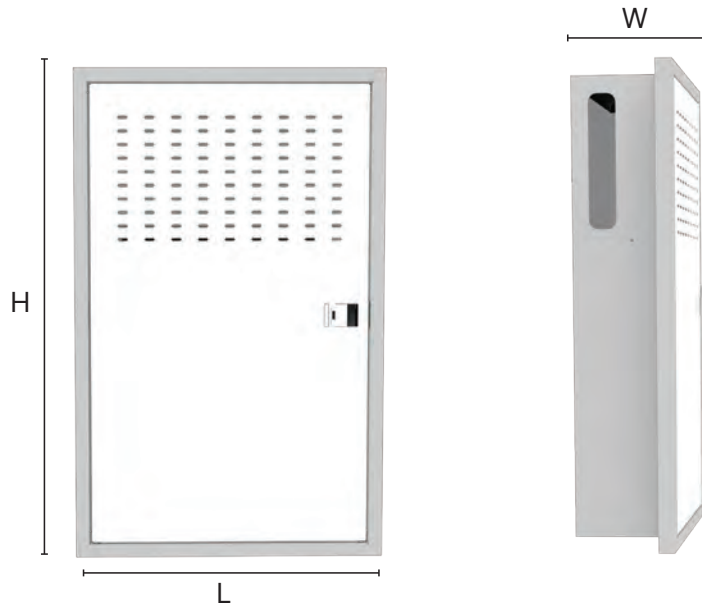

TERMOPLASTİK BUATLAR THERMOPLASTIC CONJECTIONS

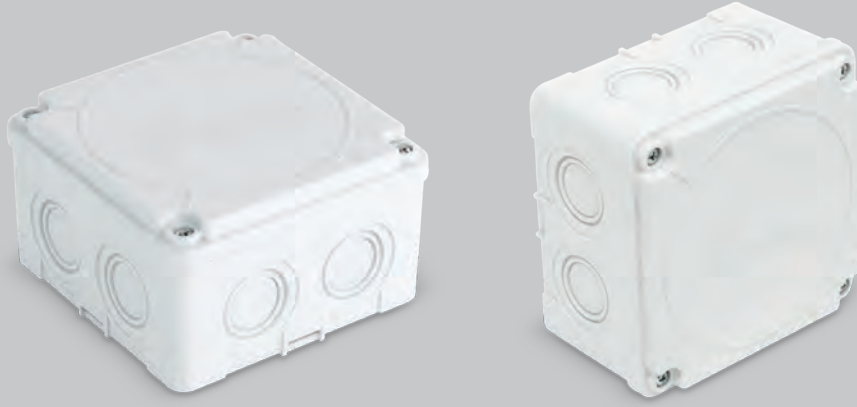

Ürün Kodu Product Code	Boyutlar (WxLxH) mm Dimensions	Koli Adedi Quantity in Carton	Fiyat Price
BR-750	70×80×40	50	48,8 TL
BR-760	85×85×40	50	53,4 TL
BR-770	110×110×55	20	79,5 TL

BUAT VE DÜBELLER JUNCTION BOXES AND DOWELS



Ürün Kodu Product Code	Ürün Adı Product Name	Koli Adedi Quantity in Carton	Fiyat Price
BR-1713	Alçıpan Buat	100	19,20 TL
BR-710	Lüks Buat Kapağı	100	5,70 TL
BR-901	7 No'lu Dübel	1000	0,60 TL
BR-902	8 No'lu Dübel	1000	0,70 TL



LÜKS KARE BUATLAR LUXURIOUS SQUARE CONJECTIONS



Ürün Kodu Product Code	Boyutlar (WxLxH) mm Dimensions	Koli Adedi Quantity in Carton	Fiyat Price
BR-730	80×80×40	140	19,90 TL
BR-731	100×100×45	140	28,90 TL
BR-732	130×130×55	180	43,60 TL
BR-734	150×150×58	108	59,60 TL
BR-733	200×200×70	60	104,70 TL

GEÇMELİ ve ALÇIPAN KASA (KAPAKSIZ) INTERLACED AND DRYWALL CASE (WITHOUT COVER)

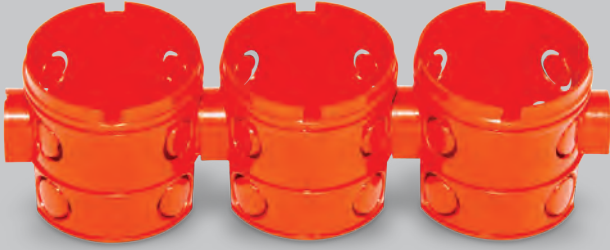

Ürün Kodu Product Code	Ürün Adı Product Name	Renk Color	Koli Adedi Quantity in Carton	Fiyat Price
BR-1413	Geçmeli Kasa Büyük	Turuncu	100	6,80 TL
BR-1708	Geçmeli Kasa Küçük	Turuncu	200	6,50 TL
BR-1712	Alçıpan Kasa	Turuncu	200	14,60 TL
BR-1413-E	Geçmeli Kasa Büyük	Siyah	100	5,60 TL
BR-1708-E	Geçmeli Kasa Küçük	Siyah	200	4,17 TL
BR-1712-E	Alçıpan Kasa	Siyah	200	14,20 TL





2'Lİ GRUP PRİZ TOPRAKLI
2 MODULE EARTHED GROUP SOCKET

Ürün Kodu Product Code	Ürün Adı Product Name	Koli Adedi Quantity in Carton	Fiyat Price
BR-1552-0	Klemensli (Kablosuz)	50	81,80 TL
BR-1552-2	2 Metre Kordonlu	12	216,30 TL
BR-1552-3	3 Metre Kordonlu	12	329,80 TL
BR-1552-5	5 Metre Kordonlu	12	476,20 TL



3'LÜ GRUP PRİZ TOPRAKLI
3 MODULE EARTHED GROUP SOCKET

Ürün Kodu Product Code	Ürün Adı Product Name	Koli Adedi Quantity in Carton	Fiyat Price
BR-1553-0	Klemensli (Kablosuz)	48	110,30 TL
BR-1553-2	2 Metre Kordonlu	12	244,90 TL
BR-1553-3	3 Metre Kordonlu	18	358,30 TL
BR-1553-5	5 Metre Kordonlu	12	504,30 TL



4'LÜ GRUP PRİZ TOPRAKLI
4 MODULE EARTHED GROUP SOCKET

Ürün Kodu Product Code	Ürün Adı Product Name	Koli Adedi Quantity in Carton	Fiyat Price
BR-1554-0	Klemensli (Kablosuz)	40	141,70 TL
BR-1554-2	2 Metre Kordonlu	12	277,30 TL
BR-1554-3	3 Metre Kordonlu	12	390,90 TL
BR-1554-5	5 Metre Kordonlu	12	535,20 TL



6'Lİ GRUP PRİZ TOPRAKLI
6 MODULE EARTHED GROUP SOCKET

Ürün Kodu Product Code	Ürün Adı Product Name	Koli Adedi Quantity in Carton	Fiyat Price
BR-1556-0	Klemensli (Kablosuz)	24	202 TL
BR-1556-2	2 Metre Kordonlu	12	336,80 TL
BR-1556-3	3 Metre Kordonlu	12	450,70 TL
BR-1556-5	5 Metre Kordonlu	12	595,20 TL





2'Lİ GRUP PRİZ TOPRAKLI SİYAH
2 MODULE EARTHED GROUP SOCKET BLACK

Ürün Kodu Product Code	Ürün Adı Product Name	Koli Adedi Quantity in Carton	Fiyat Price
BR-1572-0	Klemensli (Kablosuz)	50	78,60 TL
BR-1572-2	2 Metre Kordonlu	12	212,90 TL
BR-1572-3	3 Metre Kordonlu	12	326,30 TL
BR-1572-5	5 Metre Kordonlu	12	472,70 TL



3'LÜ GRUP PRİZ TOPRAKLI SİYAH
3 MODULE EARTHED GROUP SOCKET BLACK

Ürün Kodu Product Code	Ürün Adı Product Name	Koli Adedi Quantity in Carton	Fiyat Price
BR-1573-0	Klemensli (Kablosuz)	48	106,40 TL
BR-1573-2	2 Metre Kordonlu	12	240,80 TL
BR-1573-3	3 Metre Kordonlu	18	354,30 TL
BR-1573-5	5 Metre Kordonlu	12	500,20 TL



4'LÜ GRUP PRİZ TOPRAKLI SİYAH
4 MODULE EARTHED GROUP SOCKET BLACK

Ürün Kodu Product Code	Ürün Adı Product Name	Koli Adedi Quantity in Carton	Fiyat Price
BR-1574-0	Klemensli (Kablosuz)	40	136,20 TL
BR-1574-2	2 Metre Kordonlu	12	272,30 TL
BR-1574-3	3 Metre Kordonlu	12	385 TL
BR-1574-5	5 Metre Kordonlu	12	530 TL



6'Lİ GRUP PRİZ TOPRAKLI SİYAH
6 MODULE EARTHED GROUP SOCKET BLACK

Ürün Kodu Product Code	Ürün Adı Product Name	Koli Adedi Quantity in Carton	Fiyat Price
BR-1576-0	Klemensli (Kablosuz)	24	194,20 TL
BR-1576-2	2 Metre Kordonlu	12	328,90 TL
BR-1576-3	3 Metre Kordonlu	12	442,60 TL
BR-1576-5	5 Metre Kordonlu	12	587 TL





2'Lİ GRUP PRİZ TOPRAKLI ANAHTARLI
2 MODULE EARTHED GROUP SOCKET WITH SWITCH

Ürün Kodu Product Code	Ürün Adı Product Name	Koli Adedi Quantity in Carton	Fiyat Price
BR-1562-0	Klemensli (Kablosuz)	48	146,10 TL
BR-1562-2	2 Metre Kordonlu	12	280,30 TL
BR-1562-3	3 Metre Kordonlu	12	396,20 TL
BR-1562-5	5 Metre Kordonlu	12	540,70 TL



3'LÜ GRUP PRİZ TOPRAKLI ANAHTARLI
3 MODULE EARTHED GROUP SOCKET WITH SWITCH

Ürün Kodu Product Code	Ürün Adı Product Name	Koli Adedi Quantity in Carton	Fiyat Price
BR-1563-0	Klemensli (Kablosuz)	40	176,50 TL
BR-1563-2	2 Metre Kordonlu	12	311,80 TL
BR-1563-3	3 Metre Kordonlu	12	426 TL
BR-1563-5	5 Metre Kordonlu	12	570,80 TL



4'LÜ GRUP PRİZ TOPRAKLI ANAHTARLI
4 MODULE EARTHED GROUP SOCKET WITH SWITCH

Ürün Kodu Product Code	Ürün Adı Product Name	Koli Adedi Quantity in Carton	Fiyat Price
BR-1564-0	Klemensli (Kablosuz)	25	204,50 TL
BR-1564-2	2 Metre Kordonlu	12	339,40 TL
BR-1564-3	3 Metre Kordonlu	12	453,40 TL
BR-1564-5	5 Metre Kordonlu	12	598,40 TL



6'Lİ GRUP PRİZ TOPRAKLI ANAHTARLI
6 MODULE EARTHED GROUP SOCKET WITH SWITCH

Ürün Kodu Product Code	Ürün Adı Product Name	Koli Adedi Quantity in Carton	Fiyat Price
BR-1566-0	Klemensli (Kablosuz)	40	264,90 TL
BR-1566-2	2 Metre Kordonlu	20	399,80 TL
BR-1566-3	3 Metre Kordonlu	20	513,50 TL
BR-1566-5	5 Metre Kordonlu	16	659,50 TL





2'Lİ GRUP PRİZ TOPRAKLI ANAHTARLI SİYAH
2 MODULE EARTHED GROUP SOCKET WITH SWITCH BLACK

3'LÜ GRUP PRİZ TOPRAKLI ANAHTARLI SİYAH
3 MODULE EARTHED GROUP SOCKET WITH SWITCH BLACK

Ürün Kodu Product Code	Ürün Adı Product Name	Koli Adedi Quantity in Carton	Fiyat Price
BR-1592-0	Klemensli (Kablosuz)	48	142,70 TL
BR-1592-2	2 Metre Kordonlu	12	276,80 TL
BR-1592-3	3 Metre Kordonlu	12	392,60 TL
BR-1592-5	5 Metre Kordonlu	12	537,10 TL

Ürün Kodu Product Code	Ürün Adı Product Name	Koli Adedi Quantity in Carton	Fiyat Price
BR-1593-0	Klemensli (Kablosuz)	40	171,40 TL
BR-1593-2	2 Metre Kordonlu	12	304,60 TL
BR-1593-3	3 Metre Kordonlu	12	361,70 TL
BR-1593-5	5 Metre Kordonlu	12	565,30 TL



4'LÜ GRUP PRİZ TOPRAKLI ANAHTARLI SİYAH
4 MODULE EARTHED GROUP SOCKET WITH SWITCH BLACK

6'LI GRUP PRİZ TOPRAKLI ANAHTARLI SİYAH
6 MODULE EARTHED GROUP SOCKET WITH SWITCH BLACK

Ürün Kodu Product Code	Ürün Adı Product Name	Koli Adedi Quantity in Carton	Fiyat Price
BR-1594-0	Klemensli (Kablosuz)	25	198 TL
BR-1594-2	2 Metre Kordonlu	12	332,40 TL
BR-1594-3	3 Metre Kordonlu	12	446,60 TL
BR-1594-5	5 Metre Kordonlu	12	591,30 TL

Ürün Kodu Product Code	Ürün Adı Product Name	Koli Adedi Quantity in Carton	Fiyat Price
BR-1596-0	Klemensli (Kablosuz)	40	255,10 TL
BR-1596-2	2 Metre Kordonlu	20	389,70 TL
BR-1596-3	3 Metre Kordonlu	20	503,50 TL
BR-1596-5	5 Metre Kordonlu	16	649,40 TL





2'Lİ GRUP PRİZ TOPRAKSIZ
2 MODULE GROUP SOCKET WITHOUT EARTH



3'LÜ GRUP PRİZ TOPRAKSIZ
3 MODULE GROUP SOCKET WITHOUT EARTH

Ürün Kodu Product Code	Ürün Adı Product Name	Koli Adedi Quantity in Carton	Fiyat Price
BR-1542-0	Klemensli (Kablosuz)	50	47,40 TL
BR-1542-2	2 Metre Kordonlu	12	127,10 TL
BR-1542-3	3 Metre Kordonlu	12	155,90 TL
BR-1542-5	5 Metre Kordonlu	12	216,40 TL

Ürün Kodu Product Code	Ürün Adı Product Name	Koli Adedi Quantity in Carton	Fiyat Price
BR-1543-0	Klemensli (Kablosuz)	50	61,50 TL
BR-1543-2	2 Metre Kordonlu	12	142,30 TL
BR-1543-3	3 Metre Kordonlu	12	171 TL
BR-1543-5	5 Metre Kordonlu	12	230,40 TL



4'LÜ GRUP PRİZ TOPRAKLI UPS
4 MODULE EARTHED GROUP SOCKET FOR UPS



6'Lİ GRUP PRİZ TOPRAKLI UPS
6 MODULE EARTHED GROUP SOCKET FOR UPS

Ürün Kodu Product Code	Ürün Adı Product Name	Koli Adedi Quantity in Carton	Fiyat Price
BR-1584-0	Klemensli (Kablosuz)	40	164,60 TL
BR-1584-2	2 Metre Kordonlu	12	308,30 TL
BR-1584-3	3 Metre Kordonlu	12	429,30 TL
BR-1584-5	5 Metre Kordonlu	12	582,30 TL

Ürün Kodu Product Code	Ürün Adı Product Name	Koli Adedi Quantity in Carton	Fiyat Price
BR-1586-0	Klemensli (Kablosuz)	24	223,70 TL
BR-1586-2	2 Metre Kordonlu	12	358,50 TL
BR-1586-3	3 Metre Kordonlu	12	472,40 TL
BR-1586-5	5 Metre Kordonlu	12	616,80 TL





3'LÜ BUKET PRİZ 3 GROUNDED TRIPLE PLUG SOCKET BUKET

Ürün Kodu Product Code	Ürün Adı Product Name	Koli Adedi Quantity in Carton	Fiyat Price
BR-1514	Buket 3'lü Topraklı Fiş Priz	36	189,70 TL

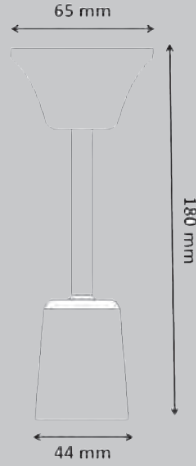

ASKI TAKIMI (E27 PLASTİK DUY) HANGER SET

Ürün Kodu Product Code	Ürün Adı Product Name	Koli Adedi Quantity in Carton	Fiyat Price
BR-001412	Askı Takımı (E27 Plastik Duy)	100	29,30 TL

E27 PORSELEN DUY E27 PORCELAIN

Ürün Kodu Product Code	Ürün Adı Product Name	Koli Adedi Quantity in Carton	Fiyat Price
132-1535	E27 Porselen Duy	400	10,30 TL

GU10 DUY GU10

Ürün Kodu Product Code	Ürün Adı Product Name	Koli Adedi Quantity in Carton	Fiyat Price
BR-GU-0001	Gu10 Duy	100	13,50 TL

AKSESUARLAR ACCESSORIES

Ürün Kodu Product Code	Ürün Adı Product Name	Kutu Adedi Quantity in box	Koli Adedi Quantity in Carton	Fiyat Price
BR-1510	Monofaze Erkek Fiş Single Phase Male Plug	50	900	64,30 TL
BR-1511	Topraklı Erkek Fiş Earthed Male Plug	50	600	82,20 TL
BR-1515	Topraklı Dişi Fiş Earthed Female Plug	40	480	93 TL
BR-1516	L Tipi Topraklı Erkek Fiş L Type Earthed Male Plug	50	600	79,10 TL



Teknik Özellikler Technical Specifications

Gövde : ABS
Body : ABS

Gövde Renkleri : Beyaz
Body Color : White

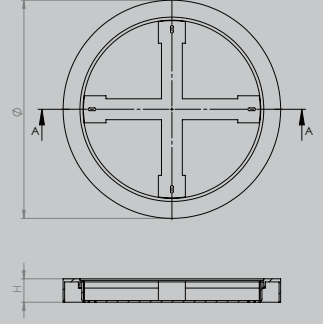

YUVARLAK SLİM LED SIVA ÜSTÜ ÇERÇEVE ROUND SLIM LED SURFACE MOUNTED FRAME

Ürün Kodu Product Code	Güç (W) Power	Ürün Adı Product Name	Boyutlar (ØxH) mm Dimensions	Koli Adedi Quantity in Carton	Fiyat Price
BR-1519	18W	Plastik Siva Üstü Yuvarlak Çerçeve	275 × 38	36	93,20 TL
BR-1522	24W	Plastik Siva Üstü Yuvarlak Çerçeve	355 × 38	34	123,70 TL

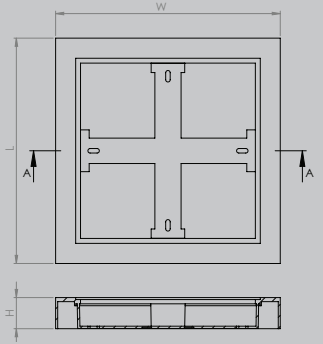

KARE SLİM LED SIVA ÜSTÜ ÇERÇEVE SQUARE SLIM LED SURFACE MOUNTED FRAME

Ürün Kodu Product Code	Güç (W) Power	Ürün Adı Product Name	Boyutlar (WxLxH) mm Dimensions	Koli Adedi Quantity in Carton	Fiyat Price
BR-1521	18W	Plastik Siva Üstü Kare Çerçeve	275 × 275 × 38	36	107,40 TL
BR-1520	24W	Plastik Siva Üstü Kare Çerçeve	355 × 355 × 38	34	147,40 TL



Teknik Özellikler
Technical Specifications

Gövde : DKP Sac
Body : DKP Metal Sheet

Gövde Renkleri : Beyaz
Body Color : White

30X30 KARE SLIM LED CLIP-IN ÇERÇEVE
30X30 SQUARE SLIM LED CLIP-IN FRAME

Ürün Kodu Product Code	Ürün Adı Product Name	Koli Adedi Quantity in Carton	Fiyat Price
134-0922	Diş Çerçeve 30×30 Led Slim Kare Clip-In Kasa	24	83,40 TL



60X60 KARE SLIM PANEL CLIP-IN ÇERÇEVE
60X60 SQUARE SLIM PANEL CLIP-IN FRAME

Ürün Kodu Product Code	Ürün Adı Product Name	Koli Adedi Quantity in Carton	Fiyat Price
134-1005	Diş Çerçeve 60×60 Led Slim Kare Clip-In Kasa	6	152,20 TL



KARE SLIM PANEL SIVA ÜSTÜ ÇERÇEVE
SQUARE SLIM PANEL SURFACE MOUNTED FRAME

Ürün Kodu Product Code	Ürün Adı Product Name	Koli Adedi Quantity in Carton	Fiyat Price
134-0995	LED 30X30 SIVA ÜSTÜ DEMONTE KASA	24	163,40 TL
134-0983	LED 30X60 SIVA ÜSTÜ DEMONTE KASA	12	198,70 TL
134-0963	LED 60X60 SIVA ÜSTÜ DEMONTE KASA	6	312,40 TL
134-0984	LED 30X120 SIVA ÜSTÜ DEMONTE KASA	6	432,60 TL

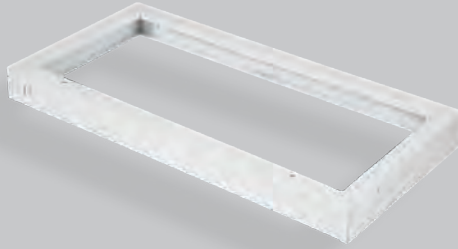

SIKMALI KABLO PABUCU/KONEKTÖRÜ CABLE CONNECTOR STANDARD SERIES

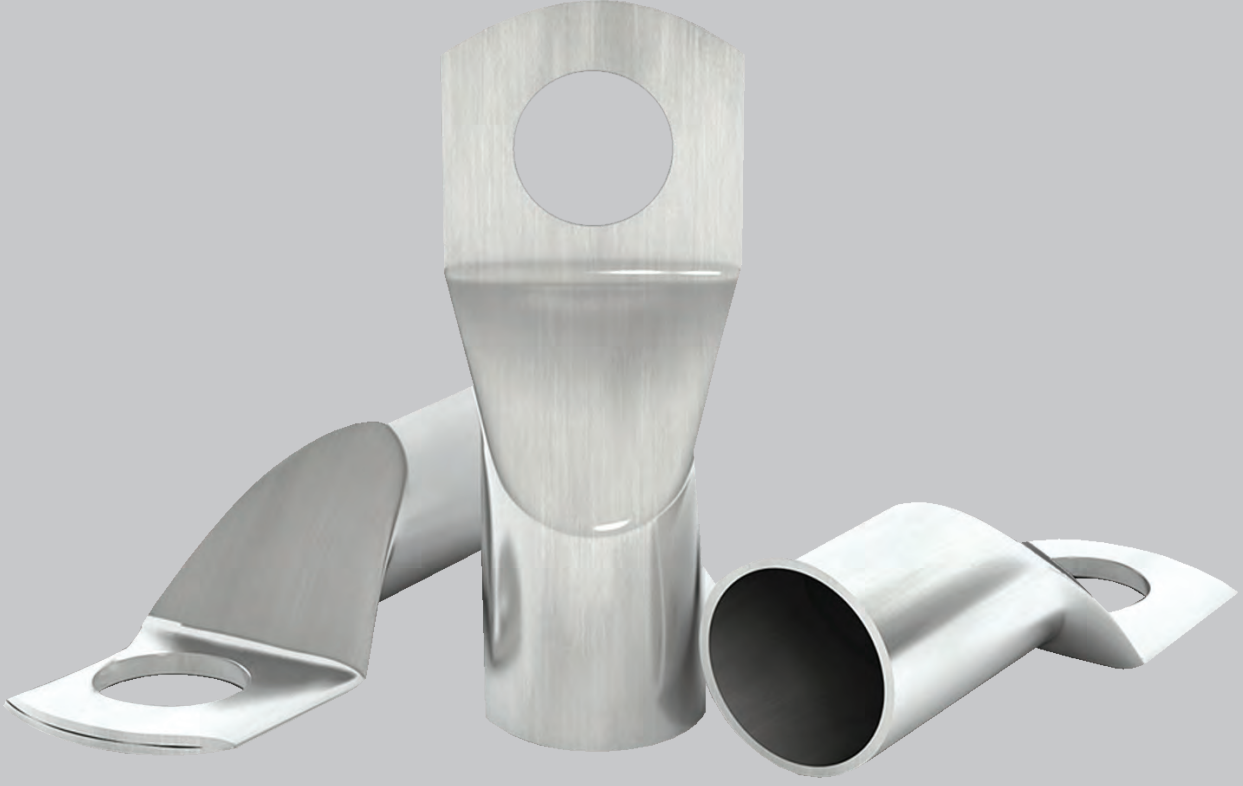

Teknik veri / Datasheet

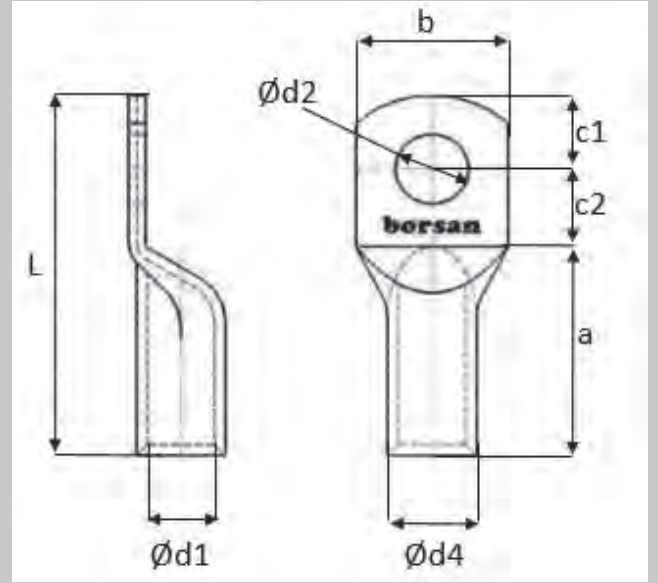

SIKMALI KABLO PABUCU/KONEKTÖRÜ

Kablo papucu/konektörü, kablo uçlarına takılarak kabloyu diğer elektriksel elemanların terminal uçlarına bağlamaya yarayan işlevsel bir aksesuardır. Konektörler iki ayrı ekipmanı birbirine bağladığı gibi bakım, onarım ve demontaj işlemlerinde operatörlere kolaylık sağlar.

CABLE CONNECTOR STANDARD SERIES

The cable connector is a functional accessory that attaches to the cable ends and connects the cable to the terminal end of other electrical elements. Connectors connect two separate equipment and provide convenience to operators in maintenance, repair and disassembly processes.



SIKMALI KABLO PABUCU CABLE LUGS STANDARD SERIES

Ürün Kodu Product Code	Kesit Section	d1	Metrik(d2) Metric(d2)	d4	Et Kalınlık Thickness	a	b	c1	c2	L	Kutu Adet Box Pcs.	Fiyat Price
BR-1780 M5	6	4,50	5,00	5,80	0,65	13,40	8,40	5,00	6,50	24,9	1500	7,60 TL
BR-1780-M5K	6	4,50	5,00	5,80	0,65	13,40	8,40	5,00	6,50	24,9	750	7,60 TL
BR-1781 M5	10	4,90	5,00	6,20	0,65	13,90	10,30	6,60	7,30	27,8	1100	8,80 TL
BR-1781-M5K	10	4,90	5,00	6,20	0,65	13,90	10,30	6,60	7,30	27,8	550	8,80 TL
BR-1782 M6	16	6,60	6,00	7,90	0,65	17,15	11,70	6,40	7,60	31,15	650	11,80 TL
BR-1782-M6K	16	6,60	6,00	7,90	0,65	17,15	11,70	6,40	7,60	31,15	325	11,80 TL
BR-1782-M8	16	6,60	8,00	7,90	0,65	17,15	11,70	6,40	7,60	31,15	650	11,80 TL
BR-1782-M8K	16	6,60	8,00	7,90	0,65	17,15	11,70	6,40	7,60	31,15	325	11,80 TL
BR-1783 M8	25	7,50	8,00	9,00	0,75	22,50	13,25	8,20	7,90	38,6	420	15,60 TL
BR-1783-M8K	25	7,50	8,00	9,00	0,75	22,50	13,25	8,20	7,90	38,6	210	15,60 TL
BR-1784 M8	35	8,70	8,00	10,80	1,05	24,85	15,50	9,20	10,35	44,4	250	27,30 TL
BR-1784-M8K	35	8,70	8,00	10,80	1,05	24,85	15,50	9,20	10,35	44,4	125	27,30 TL
BR-1794 M10	35	8,70	10,00	10,80	1,05	24,85	15,50	9,20	10,35	44,4	250	27,30 TL
BR-1794 M10K	35	8,70	10,00	10,80	1,05	24,85	15,50	9,20	10,35	44,4	125	27,30 TL
BR-1785 M10	50	10,30	10,00	12,60	1,15	28,90	18,20	11,50	11,15	51,55	170	43,00 TL
BR-1785-M10K	50	10,30	10,00	12,60	1,15	28,90	18,20	11,50	11,15	51,55	85	43,00 TL
BR-1785 M12	50	10,30	12,00	12,60	1,15	28,90	18,20	11,50	11,15	51,55	170	43,00 TL
BR-1785 M12K	50	10,30	12,00	12,60	1,15	28,90	18,20	11,50	11,15	51,55	85	43,00 TL
BR-1786 M10	70	11,70	10,00	14,50	1,40	33,90	21,00	10,10	11,10	55,1	110	58,40 TL
BR-1786 M12	70	11,70	12,00	14,50	1,40	33,90	21,00	10,10	11,10	55,1	110	58,40 TL
BR-1787 M8	95	13,80	8,00	16,50	1,35	36,70	24,20	10,55	12,05	59,3	90	70,90 TL
BR-1787 M10	95	13,80	10,00	16,50	1,35	36,70	24,20	10,55	12,05	59,3	90	70,90 TL
BR-1787 M12	95	13,80	12,00	16,50	1,35	36,70	24,20	10,55	12,05	59,3	90	70,90 TL
BR-1787 M14	95	13,80	14,00	16,50	1,35	36,70	24,20	10,55	12,05	59,3	90	70,90 TL
BR-1788 M10	120	15,90	10,00	19,10	1,60	42,55	28,20	13,90	13,60	70,05	65	111,00 TL
BR-1788 M12	120	15,90	12,00	19,10	1,60	42,55	28,20	13,90	13,60	70,05	65	111,00 TL
BR-1788 M14	120	15,90	14,00	19,10	1,60	42,55	28,20	13,90	13,60	70,05	65	111,00 TL
BR-1789 M10	150	17,30	10,00	20,60	1,65	42,20	29,95	16,70	16,80	75,7	55	131,70 TL
BR-1789 M12	150	17,30	12,00	20,60	1,65	42,20	29,95	16,70	16,80	75,7	55	131,70 TL
BR-1789 M16	150	17,30	16,00	20,60	1,65	42,20	29,95	16,70	16,80	75,7	55	131,70 TL
BR-1790 M12	185	19,05	12,00	22,60	1,78	46,60	33,25	17,35	18,95	82,9	35	164,80 TL
BR-1790 M16	185	19,05	16,00	22,60	1,78	46,60	33,25	17,35	18,95	82,9	35	164,80 TL
BR-1791 M16	240	21,55	16,00	25,20	1,83	54,30	37,25	17,35	17,95	89,6	25	208,90 TL
BR-1792 M16	300	24,30	16,00	29,00	2,35	53,50	43,00	22,00	24,50	100	20	334,00 TL
BR-1792 M20	300	24,30	20,00	29,00	2,35	53,50	43,00	22,00	24,50	100	20	334,00 TL
BR-1793 M20	400	27,35	20,00	32,80	2,73	57,50	48,50	24,80	22,20	104,5	14	478,50 TL