

30. yıl  
since  
1994

**B** bemis



**YERLİ  
ÜRETİM**



## 2025/1 FİYAT LİSTESİ

*Üreten Ülke Güçlüdür!*



*Kalite saygının ifadesidir!..*

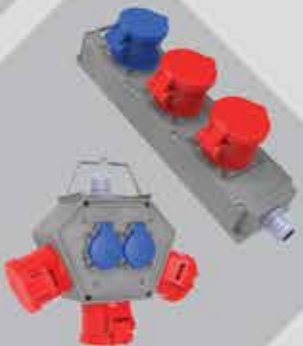

ISO 9001 ISO 14001 ISIRI TÜV NORD Ex

YÜKSELİM CE UK EAC



**Liman ve Tersaneler**

## **Endüstride Teknik Çözümler**



**Savunma Sanayi**



**Ocak ve Madenler**

*Kalite saygının ifadesidir!..*



**E-V Charge**



**Otomotiv & Karavan**

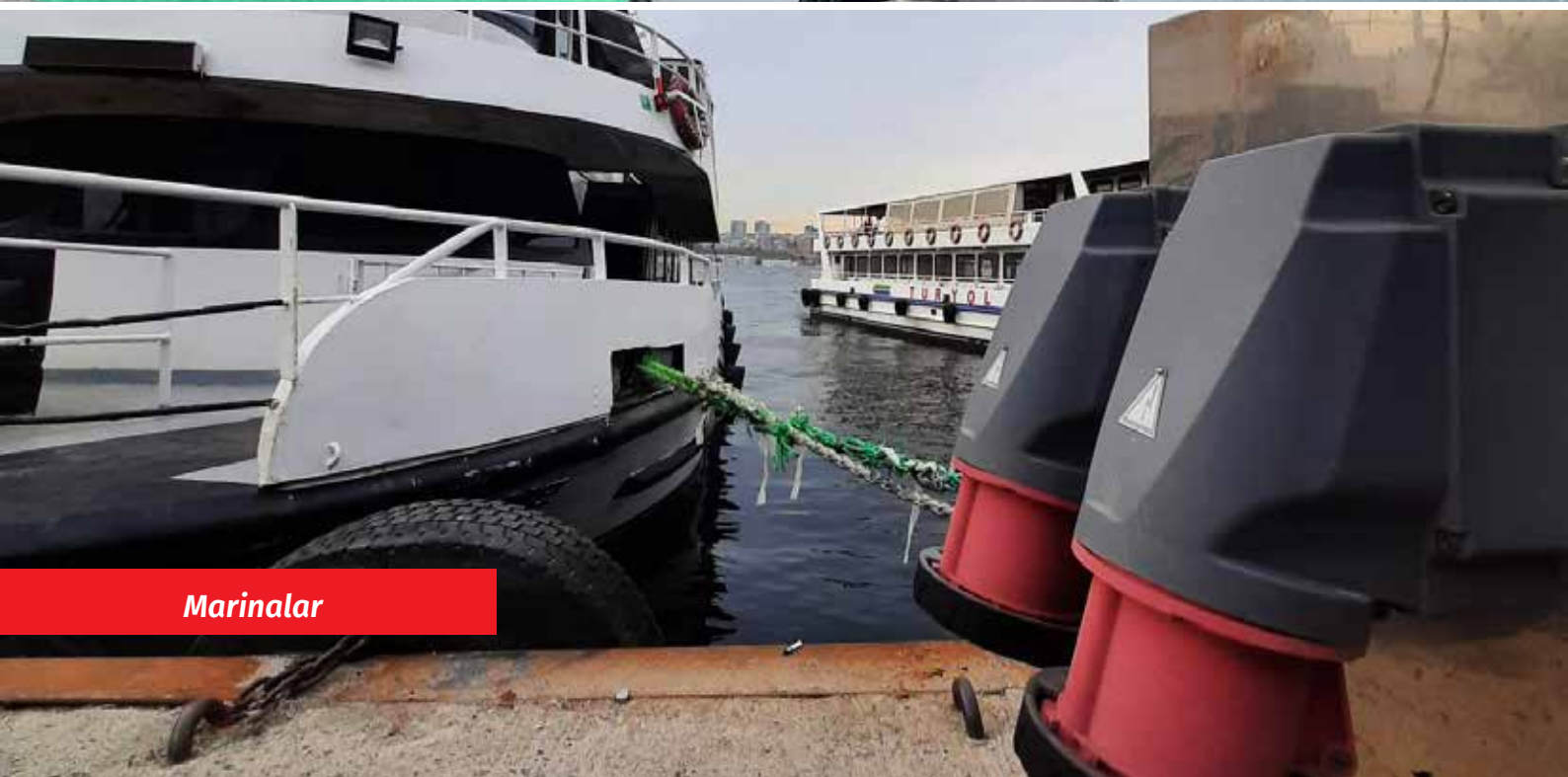

**Marinalar**

Bemis, Bursa Organize Sanayi Bölgesinde modern üretim tesisi olan 16 bin metrekare kapalı alanda; %100 yerli üretimi ile 7 bin çeşit endüstriyel elektrik malzemesi üretmektedir.

ISO 9001-2015 KALİTE YÖNETİM SİSTEMİ, CE, TSE, GOST-R, UKRSEPRO ve TÜV Kalite Belgelerine sahip olan Bemis; eğitimli ve tecrübeli ekibi ile sektör liderliğini sürdürmektedir.

Dünya markası olma yolunda planlı çalışmalar yapan Bemis; hedefine emin adımlarla ilerlemektedir.

Bemis tescilli sloganı olan “Kalite saygının ifadesidir!..” anlayışıyla ürünlerini üretmeye ve satış sonrası hizmetini sürdürmeye devam etmektedir.

Bemis, yaptığı ihracatlar ile sadece iç pazarda değil, dünya pazarında da tanınan bir marka olma yolunda seri ve sağlam adımlarla ilerlemektedir.

Alanında Türkiye'nin pazar lideri olan Bemis; farklı standartlarda plastik, metal ve kauçuk fiş prizleri, farklı güç değerlerine göre standart gerekliliklerine uygun olarak üretmektedir.

Endüstriyel fiş prizlerin yanı sıra plastik dağıtım panoları (kombinasyon kutuları), plastik ve metal buton kutuları, plastik panolar, plastik ve metal buton kutuları, plastik şalter kutuları, plastik ve metal kablo makaraları, seyyar el lambaları, emniyet trafolu aydınlatma lambaları, otomatik sarım mekanizmalı enerji aktarım sistemleri, powerbox ve panolar ile sanayinin tüm alanlarına teknik çözümler sunmaktadır.

İç pazarın yanı sıra; Avrupadaki şubesiyle (Polonya) Avrupa pazarına ve Rusya, Mısır, Cezayir, İran, Azerbaycan, Portekiz, Ukrayna, Bulgaristan, Romanya, Sırbistan, Fransa, Almanya, Polonya, Nijerya, Beyaz Rusya, Kazakistan, Irak, Türkmenistan, Özbekistan, Kırgızistan, Tacikistan, İsveç, Moğolistan, Güney Afrika, Kosova, Tunus, Ürdün, Fas, Şili, İsviçre, Kuveyt, Lübnan, Litvanya, Letonya, Estonya, Norveç, Hindistan, İspanya, Gürcistan, Makedonya, Bosna Hersek, Macaristan, Suudi Arabistan, Pakistan, Libya ve Katar'a ihracatı da bulunmaktadır.

İlkeli duruş, sistemli pazarlama ve satış, satış sonrası hizmet bizim temelimizi oluştururken, müşterilerimizin durumunu güncel bir şekilde takip ederek, yılda 1 kez yapılan müşteri memnuniyeti anketlerini değerlendirmekte, bu bağlamda eksikliklerini tespit ederek doğru yönde çalışmalar yapmaktadır.

Bemis ; ürünlerini 110 seçkin bayisi sayesinde son kullanıcı geri dönüşlerinden yararlanarak sürekli geliştirmektedir. Ürünlerinde tüketici memnuniyetini esas alan Bemis; bu doğrultuda Ar-Ge faaliyetlerine büyük önem vermekte, kolay ve fonksiyonel kullanıma uygun ürün tasarımları yapmaktadır.

**MİSYONUMUZ;** Sürekli gelişen, estetik ve güvenli ürün gamıyla, paydaşlarının isteklerini karşılamaktır.

**VİZYONUMUZ;** Yeniliklerimiz ve kalitemizle sektöre yön veren global marka olmaktır.



**Yüksek Kalite  
Cazip Fiyat**

## BEMİS TEST LABORATUVARI



Kızaran Tel



Yaşlandırma Testi



## Belge ve Sertifikalar



*Kalite saygının ifadesidir!..*



**YENİ****B bemis****2025 YENİLİKLERİMİZ****ELEKTRİKLİ ARAÇ ŞARJ ÜRÜNLERİ SERİSİ**

AC Wallbox

Sayfa 09

Mobile  
Şarj Cihazı

Şarj Prizi

Şarj Seti



Priz Tutucu

C2L Adaptör



V2L Adaptör

V2L Adaptör

Pedestal

**V20 KOMBİNASYON SERİSİ**

20 sigorta kapasiteli, IP44 ve IP67 koruma sınıfına sahip, ABS ve halogen free seçenekleri ile V20 serisi kombinasyon kutuları, endüstriyel tesislerden inşaat sahalarına, enerji iletim hatlarından tershane ve limanlara kadar geniş bir uygulama yelpazesine sahiptir. Estetik tasarımı, IP44 & IP67 koruma ve pratik montaj özellikleri sayesinde tüm sahalarda güvenilir bir enerji dağıtımını sağlar.

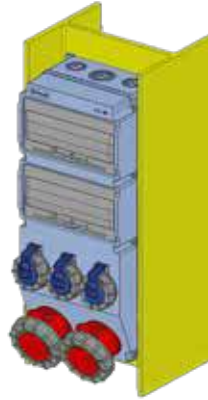

Sayfa 100

L Profil Çelik Konstrüksiyon  
Arasına Kolay Montaj**Su Terazili Kombinasyon Serisi**

V10 - V12 - V15 - V17 - V20 - V26

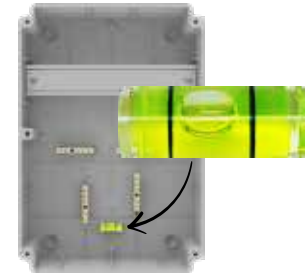
Türkiye'de ilk olarak hayata geçirilen  
uygulama son kullanıcılar için daha  
düzenli bir montaj imkanı sağlamaktadır**ATEX EX-PROOF BUAT & BUTON SERİSİ**

Sayfa 125

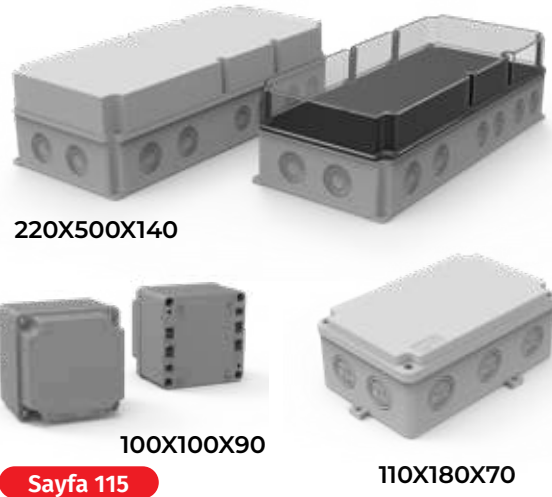
**ABS BUAT ve ALÜMİNYUM BUATLAR**

220X500X140

100X100X90

110X180X70

Sayfa 115

2 YIL  
GARANTİ

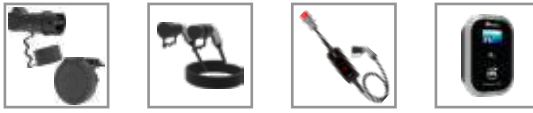

## E-V Charge Serisi

Elektrikli Araç Şarj Ürünleri Serisi

5 YIL  
GARANTİ



## Kauçuk - Plastik Fiş Priz

Monofaze - Karavan - Ark Kaynak

5 YIL  
GARANTİ



## CEE Norm Fiş Priz Serisi

16A - 32A - 63A - 125A - 160A

5 YIL  
GARANTİ



## CEE Norm Fiş Priz Serisi

24 Volt Alçak Gerilim Fiş - Priz

5 YIL  
GARANTİ



## TriBox

16A - 32A

5 YIL  
GARANTİ

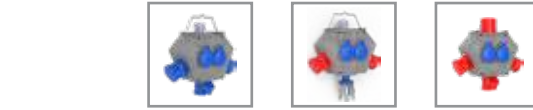

## PolyBox

16A - 32A

2 YIL  
GARANTİ



## PowerBox

2 YIL  
GARANTİ



## Interlock

16A - 32A - 63A

2 YIL  
GARANTİ

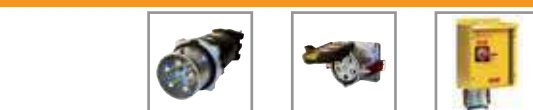

## Yüksek Amper

200A - 400A

2 YIL  
GARANTİ



## Aydınlatma

Trafo ve El Lambası

5 YIL  
GARANTİ



## Kombinasyon-Şantiye Panosu

V5 - V7 - V10 - V12 - V15 - V17 - V20 - V26

5 YIL  
GARANTİ



## Buat ve Pano Kutuları

Alüminyum - Plastik

5 YIL  
GARANTİ



## Buton ve Şalter Kutuları

Alüminyum - Plastik

5 YIL  
GARANTİ



## EX-Proof Buat ve Buton Kutuları

Alüminyum

5 YIL  
GARANTİ



## Kablo Makaraları

Metal - Plastik

2 YIL  
GARANTİ



## Otomatik Sarım Sistemli Tambur Serisi

2 YIL  
GARANTİ



## Yedek Parça





100  
yüzde  
yerli...

**B** bemis  
E-V CHARGE

Bemis E-V Charge markalı ürünlerimiz listemize bilgi amaçlı konulmuştur. Şarj ürünleri fiyat listemiz ve satış şartlarımız şarj ürünleri listemizde.

2 YIL  
GARANTİ

E-V Charge Serisi

YERLİ  
ÜRETİM



Şarj Cihazları



Şarj Fiş ve Prizler



Adaptör ve Aksesuarlar

Üreten Ülke Güçlüdür

**YENİ****B bemis**

## Elektrikli Araç Şarj Fiş ve Prizleri

| Ürün Kodu     | Açıklama                   | Kablo Uzunluğu      | Faz      | Amper      |
|---------------|----------------------------|---------------------|----------|------------|
| BEV-3016-4320 | Pano Prizi                 | 4 Noktadan Montajlı | Monofaze | 16/32/63A. |
| BEV-3016-4310 | Pano Prizi                 | 3 Noktadan Montajlı | Monofaze | 16/32/63A. |
| BEV-5032-4320 | Pano Prizi                 | 4 Noktadan Montajlı | Trifaze  | 16/32/63A. |
| BEV-5032-4310 | Pano Prizi                 | 3 Noktadan Montajlı | Trifaze  | 16/32/63A. |
| BEV-3020-1205 | Kablolu Şarj Seti          | 5m                  | Monofaze | 20A        |
| BEV-3020-1208 | Kablolu Şarj Seti          | 8m                  | Monofaze | 20A        |
| BEV-3032-1205 | Kablolu Şarj Seti          | 5m                  | Monofaze | 32A        |
| BEV-3032-1208 | Kablolu Şarj Seti          | 8m                  | Monofaze | 32A        |
| BEV-5020-1205 | Kablolu Şarj Seti          | 5m                  | Trifaze  | 20A        |
| BEV-5020-1208 | Kablolu Şarj Seti          | 8m                  | Trifaze  | 20A        |
| BEV-5032-1205 | Kablolu Şarj Seti          | 5m                  | Trifaze  | 32A        |
| BEV-5032-1208 | Kablolu Şarj Seti          | 8m                  | Trifaze  | 32A        |
| BEV-3020-2205 | Kablolu Şarj Prizi         | 5m                  | Monofaze | 20A        |
| BEV-3020-2208 | Kablolu Şarj Prizi         | 8m                  | Monofaze | 20A        |
| BEV-3032-2205 | Kablolu Şarj Prizi         | 5m                  | Monofaze | 32A        |
| BEV-3032-2208 | Kablolu Şarj Prizi         | 8m                  | Monofaze | 32A        |
| BEV-5020-2205 | Kablolu Şarj Prizi         | 5m                  | Trifaze  | 20A        |
| BEV-5020-2208 | Kablolu Şarj Prizi         | 8m                  | Trifaze  | 20A        |
| BEV-5032-2205 | Kablolu Şarj Prizi         | 5m                  | Trifaze  | 32A        |
| BEV-5032-2208 | Kablolu Şarj Prizi         | 8m                  | Trifaze  | 32A        |
| BAK-8000-0000 | Fiş-Priz Şarj Seti Çantası |                     |          |            |

BEV-5032-4320

**4 NOKTADAN BAĞLANTILI  
32A PANO PRİZİ**

BEV-5032-1205

**TRİFAZE 32A 5M KABLULU  
ŞARJ SETİ**

BEV-5032-2205

**TRİFAZE 32A ŞARJ PRİZİ  
5M KABLULU**

BAK-8000-0000

**ŞARJ SETİ ÇANTASI**

| Ürün Kodu     | Açıklama  | kW     | Faz      | Amper |
|---------------|---|--------|----------|-------|
| BEV-2316-4302 | Ekranlı Pano Prizli Tak Çalıştır Model 1 Charger                            | 7,4 kw | Monofaze | 32A   |
| BEV-2516-4303 | Ekranlı Pano Prizli Tak Çalıştır Model 1 Charger                            | 11 kw  | Trifaze  | 16A   |
| BEV-2516-4304 | Ekranlı Pano Prizli Tak Çalıştır Model 1 Charger                            | 22 kw  | Trifaze  | 32A   |
| BEV-1316-4302 | Ekranlı Pano Prizli Model 2 Charger Plus                                    | 7,4 kw | Monofaze | 32A   |
| BEV-1516-4303 | Ekranlı Pano Prizli Model 2 Charger Plus                                    | 11 kw  | Trifaze  | 16A   |
| BEV-1516-4304 | Ekranlı Pano Prizli Model 2 Charger Plus                                    | 22 kw  | Trifaze  | 32A   |
| BEV-2332-2352 | Ekranlı Kablo Ucu Prizli Model 1 Charger <b>(Kablo 5m.)</b>                 | 7,4 kw | Monofaze | 32A   |
| BEV-2532-2353 | Ekranlı Kablo Ucu Prizli Model 1 Charger <b>(Kablo 5m.)</b>                 | 11 kw  | Trifaze  | 16A   |
| BEV-2532-2354 | Ekranlı Kablo Ucu Prizli Model 1 Charger <b>(Kablo 5m.)</b>                 | 22 kw  | Trifaze  | 32A   |
| BEV-1332-2352 | Ekranlı Kablo Ucu Prizli Model 2 Charger Plus <b>(Kablo 5m.)</b>            | 7,4 kw | Monofaze | 32A   |
| BEV-1532-2353 | Ekranlı Kablo Ucu Prizli Model 2 Charger Plus <b>(Kablo 5m.)</b>            | 11 kw  | Trifaze  | 16A   |
| BEV-1532-2354 | Ekranlı Kablo Ucu Prizli Model 2 Charger Plus <b>(Kablo 5m.)</b>            | 22 kw  | Trifaze  | 32A   |
| BEV-3532-2354 | Ekranlı Kablo Ucu Prizli Full Ticari Model 3 Charger Pro <b>(Kablo 5m.)</b> | 22 kw  | Trifaze  | 32A   |
| BEV-3516-4304 | Ekranlı Pano Prizli Full Ticari Model 3 Charger Pro                         | 22 kw  | Trifaze  | 32A   |

E-V CHARGER MODELLER



MODEL-1  
CHARGER



MODEL-2  
CHARGER +



MODEL-3  
CHARGER PRO

E-V Charge

| Ürün Kodu     | Açıklama    | Kablo Uzunluğu | kW           | Amper     |
|---------------|-------------|----------------|--------------|-----------|
| BEV-1111-0001 | Mini Mobile | 5 metre        | 2,3 - 3,7 kw | 10A - 16A |
| BEV-1221-0001 | Mono Mobile | 5 metre        | 3,7 - 7,4 kw | 16A - 32A |
| BEV-2331-0001 | Pro Mobile  | 5 metre        | 11 - 22 kw   | 16A - 32A |

MOBILE CHARGER



MODEL-1  
MINI MOBILE



MODEL-2  
MONO MOBILE



MODEL-3  
PRO MOBILE

**V2L Adaptör ne işe yarar?**

V2L (Vehicle to Load) adaptörü, elektrikli araçların bataryasından enerji çıkışı sağlayarak harici cihazları çalıştırmamıza olanak tanır. Acil durumlar veya doğal afetler gibi hallerde kullanılır. Ayrıca araçtan araca şarj imkanı da sağlar.

| Ürün Kodu       | Açıklama                                   |
|-----------------|--|
| BKT-2102-2001   | V2L Tek Çıkışlı Adaptör                    |
| BEV2L-3201-3203 | V2L Tekli Uzatma Priz Adaptör (3m Kablolu) |
| BEV2L-3202-3203 | V2L 2'li Uzatma Priz Adaptör (3m Kablolu)  |
| BEV2L-3203-3203 | V2L 3'lü Uzatma Priz Adaptör (3m Kablolu)  |

Tek Çıkışlı  
V2L Adaptör



BKT-2102-2001

Tekli Priz Uzatma  
V2L Adaptör



BEV2L-3201-3203

2'li Priz Uzatma  
V2L Adaptör



BEV2L-3202-3203

3'lü Priz Uzatma  
V2L Adaptör



BEV2L-3203-3203

## Elektrikli Araç C2L Adaptörleri

**C2L Adaptör ne işe yarar?**

C2L (Şarj Cihazından Yüke) adaptör, günümüzde giderek yaygınlaşan elektrikli araçların şarj edilmesinde kullanılan MOD 2 ve MOD 3 AC Şarj İstasyonlarını, MOD 1 (standart fiş-priz) şarj bağlantısına dönüştüren bir adaptördür. Bu sayede, Citroen Ami, Amperio, Fiat Topolino gibi standart fiş-priz (MOD 1) bağlantısını kullanarak şarj olabilen elektrikli araçların yanı sıra elektrikli bisikletler, elektrikli scooterlar, akülü arabalar ve elektrikli cihazlar da MOD 2 ve MOD 3 AC Şarj istasyonlarını kullanabilir.

| Ürün Kodu        | Açıklama   |
|------------------|--|
| BEVC2L-3301-3603 | C2L Tekli Uzatma Fişli Adaptör (3m Kablolu)        |
| BEVC2L-3302-3603 | C2L 2'li Uzatma Fişli Adaptör (3m Kablolu)         |
| BEVC2L-3303-3603 | C2L 3'lü Uzatma Fişli Adaptör (3m Kablolu)         |
| BEVC2L-5305-3603 | C2L 5/32A Prizli Uzatma Fişli Adaptör (3m Kablolu) |

Tekli Priz Uzatma  
C2L Adaptör



BEVC2L-3301-3603

2'li Priz Uzatma  
C2L Adaptör



BEVC2L-3302-3603

3'lü Priz Uzatma  
C2L Adaptör



BEVC2L-3303-3603

5/32A. Prizli  
C2L Adaptör



BEVC2L-5305-3603

| Ürün Kodu     | Açıklama   |
|---------------|--|
| BKT-0108-2211 | Cee Norm Adaptör 3x2,5 Ttr 1/16A Fiş - 5/16A Priz (30cm Kablolu) |
| BKT-0508-2211 | Cee Norm Adaptör 3x2,5 Ttr 3/16A Fiş - 5/16A Priz (30cm Kablolu) |
| BKT-1008-2511 | Cee Norm Adaptör 5x2,5 Ttr 5/32A Fiş - 5/16A Priz (30cm Kablolu) |
| BKT-0109-2211 | Cee Norm Adaptör 3x2,5 Ttr 1/16A Fiş - 3/32A Priz (30cm Kablolu) |
| BKT-0111-2211 | Cee Norm Adaptör 3x2,5 Ttr 1/16A Fiş - 5/32A Priz (30cm Kablolu) |
| BKT-0511-2211 | Cee Norm Adaptör 3x2,5 Ttr 3/16A Fiş - 5/32A Priz (30cm Kablolu) |
| BKT-0711-2511 | Cee Norm Adaptör 5x2,5 Ttr 5/16A Fiş - 5/32A Priz (30cm Kablolu) |
| BAK-8300-0000 | Pedestal   |
| BAK-8200-0000 | Priz Tutucu  |



Pedestal  
**BAK-8300-0000**



Priz Tutucu  
**BAK-8200-0000**

5/16A Priz  
1/16A Fiş



**BKT-0108-2211**

5/16A Priz  
3/16A Fiş



**BKT-0508-2211**

5/16A Priz  
5/32A Fiş



**BKT-1008-2511**

3/32A Priz  
1/16A Fiş



**BKT-0109-2211**

5/32A Priz  
1/16A Fiş



**BKT-0111-2211**

5/32A Priz  
3/16A Fiş



**BKT-0511-2211**

5/32A Priz  
5/16A Fiş



**BKT-0711-2511**

## MONOFAZE KAUÇUK GRUP PRİZLER 1/16A. (2P+E) 200/250V~

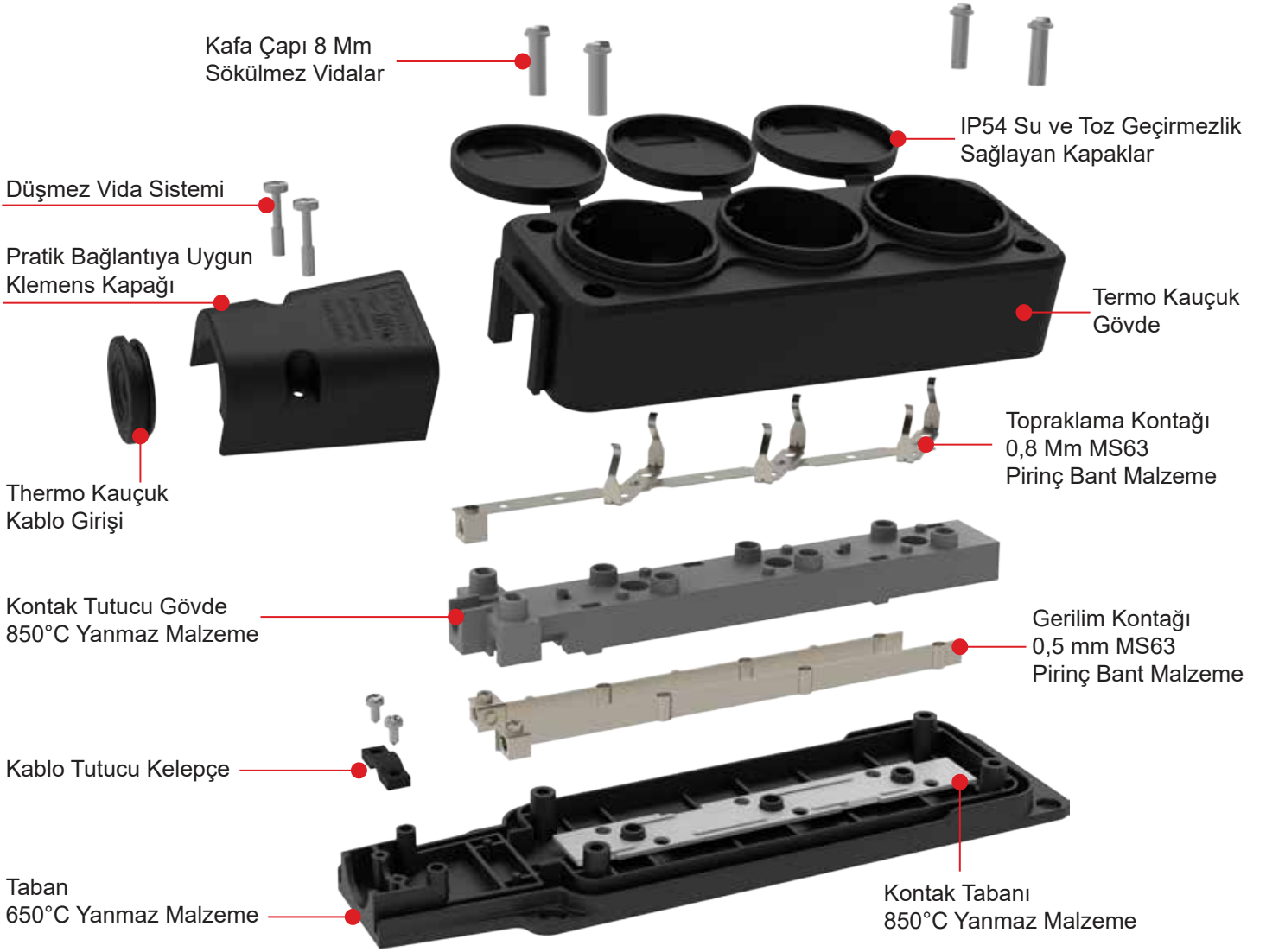

### RENK SEÇENEKLERİ



BV6-1402-3613



BV5-1402-3613



BV4-1402-3613



BV3-1402-3613

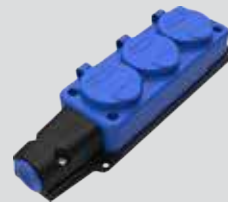

BV2-1402-3613



BV1-1402-3613

100  
yüzde  
yerli...

**B** bemis

5 YIL  
GARANTİ

Kauçuk - Plastik Fiş Priz

YERLİ  
ÜRETİM



Monofaze Seri



Karavan Seri



Ark Kaynak Seri

Üreten Ülke Güçlüdür

| Ürün Kodu     | Açıklama         | IP   | Kutu | Koli | Fiyat     |
|---------------|------------------|------|------|------|-----------|
| BK1-1402-2011 | Düz Fiş          | IP44 | 30   | 360  | 90,00 TL  |
| BK1-1402-2311 | Uzatma Priz      | IP44 | 25   | 200  | 131,00 TL |
| BK1-1402-3511 | Duvar Priz       | IP54 | 12   | 144  | 159,00 TL |
| BK1-1402-3612 | İkili Grup Priz  | IP54 | 8    | 96   | 268,00 TL |
| BK1-1402-3613 | Üçlü Grup Priz   | IP54 | 7    | 84   | 300,00 TL |
| BK1-1402-3614 | Dörtlü Grup Priz | IP54 | 8    | 64   | 359,00 TL |
| BK1-1402-2022 | Eğik Fiş         | IP44 | 20   | 240  | 107,00 TL |
| BK1-1402-2021 | Kulplu Eğik Fiş  | IP44 | 20   | 240  | 115,00 TL |



BK1-1402-2011



BK1-1402-2311



BK1-1402-3511



BK1-1402-3612



BK1-1402-3613



BK1-1402-3614

### Fransız Tipi Monofaze Kauçuk Seri 1x16A. (2P+E) 200/250V.

| Ürün Kodu     | Açıklama                      | IP   | Kutu | Koli | Fiyat     |
|---------------|-------------------------------|------|------|------|-----------|
| BK1-1402-2031 | Düz Fiş Fransız Tipi          | IP44 | 30   | 360  | 104,00 TL |
| BK1-1402-2361 | Uzatma Priz Fransız Tipi      | IP44 | 25   | 200  | 148,00 TL |
| BK1-1402-3622 | İkili Grup Priz Fransız Tipi  | IP54 | 8    | 96   | 309,00 TL |
| BK1-1402-3623 | Üçlü Grup Priz Fransız Tipi   | IP54 | 7    | 84   | 370,00 TL |
| BK1-1402-3624 | Dörtlü Grup Priz Fransız Tipi | IP54 | 8    | 64   | 404,00 TL |



BK1-1402-2031



BK1-1402-2361



BK1-1402-3622



BK1-1402-3623



BK1-1402-3624

### UPS Monofaze Kauçuk Fişler 1x16A. (2P+E) 200/250V.

| Ürün Kodu     | Açıklama            | IP   | Kutu | Koli | Fiyat     |
|---------------|---------------------|------|------|------|-----------|
| BK1-1402-2031 | UPS Düz Fiş         | IP44 | 30   | 360  | 104,00 TL |
| BK1-1402-2042 | UPS Eğik Fiş        | IP44 | 20   | 240  | 118,00 TL |
| BK1-1402-2041 | UPS Kulplu Eğik Fiş | IP44 | 20   | 240  | 129,00 TL |



BK1-1402-2031



BK1-1402-2042



BK1-1402-2041



# Renkli Monofaze Kauçuk Seri 1x16A. (2P+E) 200/250V.



| Ürün Kodu     | Açıklama                 | IP   | Kutu | Koli | Fiyat     |
|---------------|--------------------------|------|------|------|-----------|
| BV2-1402-3511 | Duvar Priz (Mavi)        | IP54 | 12   | 144  | 174,00 TL |
| BV3-1402-3511 | Duvar Priz (Sarı)        | IP54 | 12   | 144  | 174,00 TL |
| BV2-1402-3612 | İkili Grup Priz (Mavi)   | IP54 | 8    | 96   | 301,00 TL |
| BV3-1402-3612 | İkili Grup Priz (Sarı)   | IP54 | 8    | 96   | 301,00 TL |
| BV1-1402-3613 | Üçlü Grup Priz (Yeşil)   | IP54 | 7    | 84   | 353,00 TL |
| BV2-1402-3613 | Üçlü Grup Priz (Mavi)    | IP54 | 7    | 84   | 353,00 TL |
| BV3-1402-3613 | Üçlü Grup Priz (Sarı)    | IP54 | 7    | 84   | 353,00 TL |
| BV4-1402-3613 | Üçlü Grup Priz (Turuncu) | IP54 | 7    | 84   | 353,00 TL |
| BV5-1402-3613 | Üçlü Grup Priz (Gri)     | IP54 | 7    | 84   | 353,00 TL |
| BV6-1402-3613 | Üçlü Grup Priz (Kırmızı) | IP54 | 7    | 84   | 353,00 TL |
| BV2-1402-3614 | Dörtlü Grup Priz (Mavi)  | IP54 | 8    | 64   | 395,00 TL |
| BV3-1402-3614 | Dörtlü Grup Priz (Sarı)  | IP54 | 8    | 64   | 395,00 TL |



| Ürün Kodu     | Açıklama          | IP   | Kutu | Koli | Fiyat     |
|---------------|-------------------|------|------|------|-----------|
| BV1-1402-2011 | Düz Fiş (Yeşil)   | IP44 | 30   | 360  | 100,00 TL |
| BV2-1402-2011 | Düz Fiş (Mavi)    | IP44 | 30   | 360  | 100,00 TL |
| BV3-1402-2011 | Düz Fiş (Sarı)    | IP44 | 30   | 360  | 100,00 TL |
| BV4-1402-2011 | Düz Fiş (Turuncu) | IP44 | 30   | 360  | 100,00 TL |
| BV5-1402-2011 | Düz Fiş (Gri)     | IP44 | 30   | 360  | 100,00 TL |
| BV6-1402-2011 | Düz Fiş (Kırmızı) | IP44 | 30   | 360  | 100,00 TL |



| Ürün Kodu     | Açıklama              | IP   | Kutu | Koli | Fiyat     |
|---------------|-----------------------|------|------|------|-----------|
| BV1-1402-2311 | Uzatma Priz (Yeşil)   | IP44 | 25   | 200  | 145,00 TL |
| BV2-1402-2311 | Uzatma Priz (Mavi)    | IP44 | 25   | 200  | 145,00 TL |
| BV3-1402-2311 | Uzatma Priz (Sarı)    | IP44 | 25   | 200  | 145,00 TL |
| BV4-1402-2311 | Uzatma Priz (Turuncu) | IP44 | 25   | 200  | 145,00 TL |
| BV5-1402-2311 | Uzatma Priz (Gri)     | IP44 | 25   | 200  | 145,00 TL |
| BV6-1402-2311 | Uzatma Priz (Kırmızı) | IP44 | 25   | 200  | 145,00 TL |



Not: Renkli ürünler siparişe göre üretilir.

| Ürün Kodu     | Açıklama                  | IP   | Kutu | Koli | Fiyat     |
|---------------|---------------------------|------|------|------|-----------|
| BV1-1402-2021 | Kulplu Eğik Fiş (Yeşil)   | IP44 | 20   | 240  | 127,00 TL |
| BV2-1402-2021 | Kulplu Eğik Fiş (Mavi)    | IP44 | 20   | 240  | 127,00 TL |
| BV3-1402-2021 | Kulplu Eğik Fiş (Sarı)    | IP44 | 20   | 240  | 127,00 TL |
| BV4-1402-2021 | Kulplu Eğik Fiş (Turuncu) | IP44 | 20   | 240  | 127,00 TL |
| BV5-1402-2021 | Kulplu Eğik Fiş (Gri)     | IP44 | 20   | 240  | 127,00 TL |
| BV6-1402-2021 | Kulplu Eğik Fiş (Kırmızı) | IP44 | 20   | 240  | 127,00 TL |



BV1-1402-2021



BV2-1402-2021



BV3-1402-2021



BV4-1402-2021



BV5-1402-2021



BV6-1402-2021

**UPS Renkli Monofaze Kauçuk Fişler  
1x16A. (2P+E) 200/250V.**

| Ürün Kodu     | Açıklama              | IP   | Kutu | Koli | Fiyat     |
|---------------|-----------------------|------|------|------|-----------|
| BV1-1402-2031 | UPS Düz Fiş (Yeşil)   | IP44 | 30   | 360  | 114,00 TL |
| BV2-1402-2031 | UPS Düz Fiş (Mavi)    | IP44 | 30   | 360  | 114,00 TL |
| BV3-1402-2031 | UPS Düz Fiş (Sarı)    | IP44 | 30   | 360  | 114,00 TL |
| BV4-1402-2031 | UPS Düz Fiş (Turuncu) | IP44 | 30   | 360  | 114,00 TL |
| BV5-1402-2031 | UPS Düz Fiş (Gri)     | IP44 | 30   | 360  | 114,00 TL |
| BV6-1402-2031 | UPS Düz Fiş (Kırmızı) | IP44 | 30   | 360  | 114,00 TL |



BV1-1402-2031



BV2-1402-2031



BV3-1402-2031



BV4-1402-2031



BV5-1402-2031



BV6-1402-2031

**UPS Renkli Monofaze Kauçuk Kulplu Eğik Fişler  
1x16A. (2P+E) 200/250V.**

| Ürün Kodu     | Açıklama                      | IP   | Kutu | Koli | Fiyat     |
|---------------|-------------------------------|------|------|------|-----------|
| BV1-1402-2041 | UPS Kulplu Eğik Fiş (Yeşil)   | IP44 | 20   | 240  | 132,00 TL |
| BV2-1402-2041 | UPS Kulplu Eğik Fiş (Mavi)    | IP44 | 20   | 240  | 132,00 TL |
| BV3-1402-2041 | UPS Kulplu Eğik Fiş (Sarı)    | IP44 | 20   | 240  | 132,00 TL |
| BV4-1402-2041 | UPS Kulplu Eğik Fiş (Turuncu) | IP44 | 20   | 240  | 132,00 TL |
| BV5-1402-2041 | UPS Kulplu Eğik Fiş (Gri)     | IP44 | 20   | 240  | 132,00 TL |
| BV6-1402-2041 | UPS Kulplu Eğik Fiş (Kırmızı) | IP44 | 20   | 240  | 132,00 TL |



BV1-1402-2041



BV2-1402-2041



BV3-1402-2041



BV4-1402-2041



BV5-1402-2041



BV6-1402-2041

## MONOFAZE KAÜÇUK FİŞLER 1/16A. (2P+E) 200/250V~

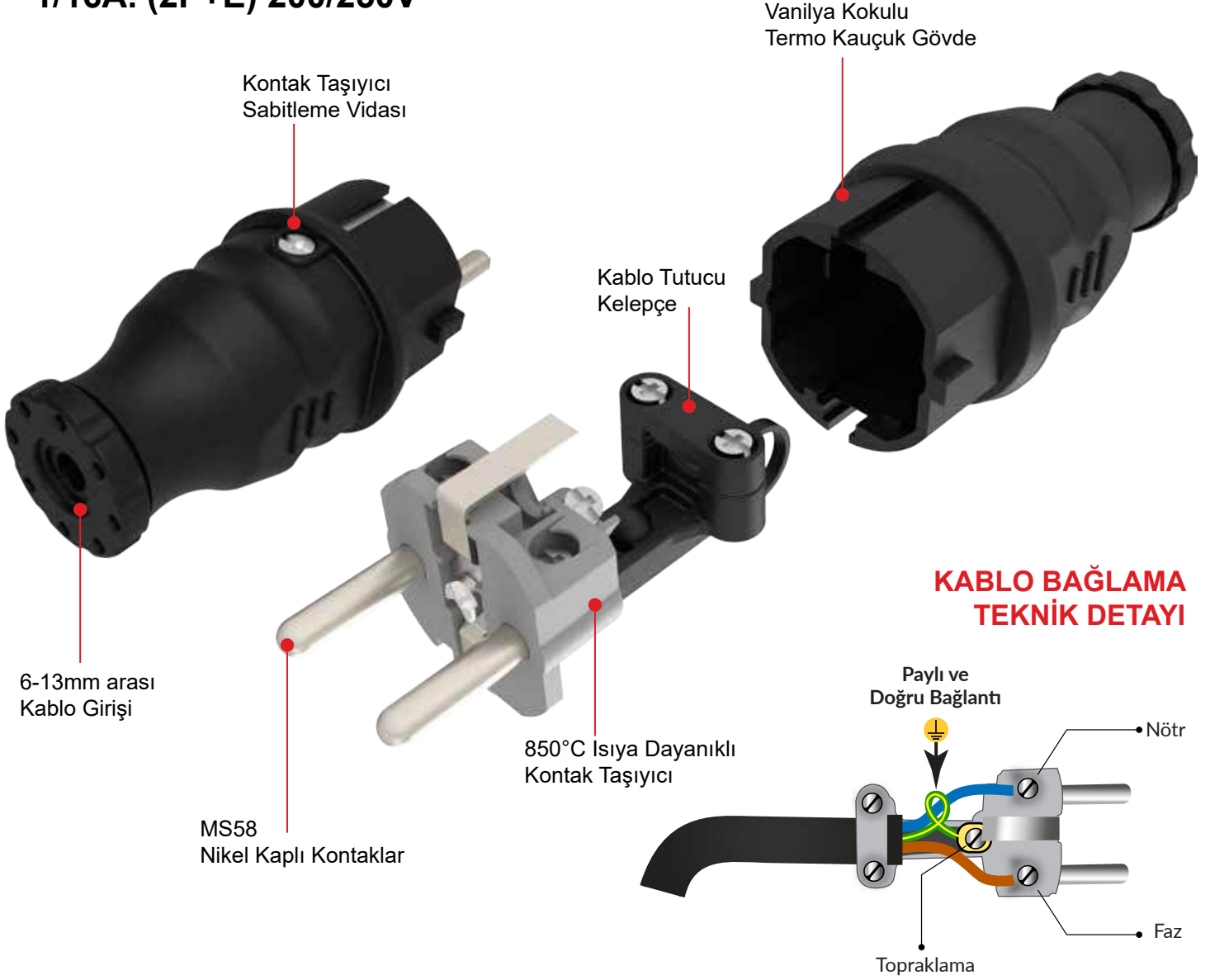

## RENK SEÇENEKLERİ

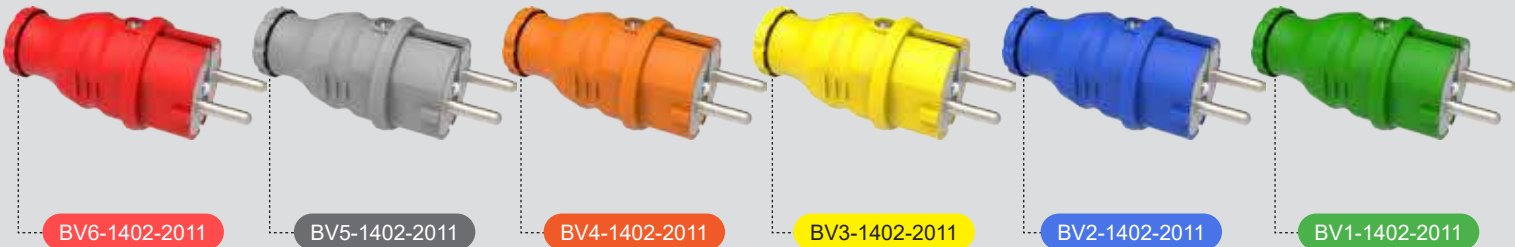



MATKAP YOK



TORNAVİDA YOK



VİDA YOK

## Dünya'da ilk 16A. Somunlu Pano Priz



## Çok Pratik, Vidasız MONTAJ



*Kalite saygının ifadesidir!..*

Günümüz koşullarında teknik adam sıkıntısı, adam saat maliyetlerinin yüksekliği biz üreticileri daha pratik, daha sağlam, tasarımlar yapmaya mecbur bırakmıştır. Biz de bu kapsamda yaptığımız AR-GE çalışmaları sonucu pano prizinde çok ciddi gelişme kaydettik. Küçük bir ürün olmasına rağmen 4 noktadan montajı yapılan ve montajı yapıldıktan sonra kablo bağlama zorluğu olan bu ürünün iki montaj zorluğunu da çözdük. Yeni ürünümüz vidasız somunlu montaj yapma imkanı ve vidasız kablo bağlama imkanı sunarak oldukça pratik ve daha sağlam olmaktadır. Tüm kullanıcıların dikkatine sunulur.

| Ürün Kodu     | Açıklama  | IP   | Kutu | Koli | Fiyat     |
|---------------|---|------|------|------|-----------|
| BS1-1402-7011 | Düz Fiş   | IP68 | 10   | 80   | 464,00 TL |
| BS1-1402-7311 | Uzatma Priz   | IP68 | 10   | 80   | 464,00 TL |
| BS1-1402-7114 | Makine Fiş  | IP68 | 8    | 96   | 427,00 TL |
| BS1-1402-7510 | Vidalı Bağlantılı Düz Duvar Priz                            | IP68 | 6    | 48   | 634,00 TL |
| BS1-1402-7511 | Hızlı Bağlantılı Düz Duvar Priz                             | IP68 | 6    | 48   | 660,00 TL |
| BS1-1402-7210 | Duvar Fiş   | IP68 | 6    | 48   | 662,00 TL |
| BS1-1402-7535 | 90° Eğik Duvar Priz   | IP68 | 3    | 36   | 735,00 TL |
| BS1-1402-7236 | 90° Eğik Duvar Fiş  | IP68 | 3    | 36   | 761,00 TL |
| BS1-1402-7410 | Vidalı Bağlantılı Makine Priz (Çocuk Koruma Kilitsiz)       | IP68 | 8    | 96   | 433,00 TL |
| BS1-1402-7416 | Hızlı Bağlantılı Makine Priz (Çocuk Koruma Kilitsiz)        | IP68 | 8    | 96   | 454,00 TL |
| BS1-1402-7417 | Hızlı Bağlantılı Makine Priz (Çocuk Koruma Kilitli)         | IP68 | 8    | 96   | 474,00 TL |
| BS1-1402-7440 | Vidalı Bağlantılı Somunlu Pano Priz (Çocuk Koruma Kilitsiz) | IP68 | 12   | 144  | 433,00 TL |
| BS1-1402-7446 | Hızlı Bağlantılı Somunlu Pano Priz (Çocuk Koruma Kilitsiz)  | IP68 | 12   | 144  | 453,00 TL |
| BS1-1402-7476 | Hızlı Bağlantılı Somunlu Pano Priz (Çocuk Koruma Kilitli)   | IP68 | 12   | 144  | 474,00 TL |

**TÜRKİYE’de İLK**  
**IP68 su sızdırmaz monofaze seri.**

Düz Fiş



BS1-1402-7011

Makine Fişi



BS1-1402-7114

Eğik Duvar Fişi



BS1-1402-7236

Düz Duvar Fişi



BS1-1402-7210

Uzatma Prizi



BS1-1402-7311

Eğik Duvar Prizi



BS1-1402-7535

Vidalı Bağlantılı Düz Duvar Prizi



BS1-1402-7510

Hızlı Bağlantılı Düz Duvar Prizi



BS1-1402-7511

Vidalı Bağlantılı Makine Priz



BS1-1402-7410

Hızlı Bağlantılı Makine Priz



BS1-1402-7416

Vidalı Bağlantılı Somunlu Pano Priz



BS1-1402-7440

Hızlı Bağlantılı Somunlu Pano Priz



BS1-1402-7446



| Ürün Kodu     | Açıklama    | IP   | Kutu | Koli | Fiyat    |
|---------------|-------------|------|------|------|----------|
| BP1-1402-2011 | Düz Fiş     | IP44 | 35   | 420  | 81,00 TL |
| BP1-1402-1311 | Uzatma Priz | IP20 | 20   | 240  | 97,00 TL |
| BP1-1402-2022 | Eğik Fiş    | IP44 | 35   | 420  | 79,00 TL |

| Ürün Kodu     | Açıklama                      | IP   | Kutu | Koli | Fiyat     |
|---------------|-------------------------------|------|------|------|-----------|
| BY8-1402-2440 | Somunlu Pano Priz             | IP44 | 30   | 360  | 103,00 TL |
| BY8-1402-2445 | UPS Somunlu Pano Priz         | IP44 | 30   | 360  | 114,00 TL |
| BY8-1402-2700 | Pano Priz (Yatay Giriş)       | IP44 | 30   | 360  | 99,00 TL  |
| BY8-1402-2705 | Pano Priz (UPS - Yatay Giriş) | IP44 | 30   | 360  | 110,00 TL |
| BY8-1402-3510 | Duvar Kasalı P. Priz          | IP44 | 12   | 144  | 177,00 TL |
| BY5-1402-2700 | Pano Priz (Gri)               | IP44 | 30   | 360  | 102,00 TL |
| BY9-1402-2700 | Pano Priz (Siyah)             | IP44 | 30   | 360  | 102,00 TL |
| BY8-1402-2720 | UPS Pano Priz (Sarı)          | IP44 | 30   | 360  | 133,00 TL |
| BP1-1402-2510 | Duvar Priz                    | IP44 | 6    | 72   | 202,00 TL |
| BY8-1402-3700 | Pano Priz                     | IP54 | 25   | 300  | 106,00 TL |
| BY9-1402-3700 | Pano Priz (Siyah)             | IP54 | 25   | 300  | 106,00 TL |
| BY3-1402-3700 | Pano Priz (Sarı)              | IP54 | 25   | 300  | 106,00 TL |
| BP1-1402-2410 | Makine Priz                   | IP44 | 18   | 144  | 129,00 TL |

| Ürün Kodu     | Açıklama                    | IP   | Kutu | Koli | Fiyat     |
|---------------|-----------------------------|------|------|------|-----------|
| BP1-1402-2013 | Düz Fiş                     | IP44 | 10   | 120  | 248,00 TL |
| BP1-1402-2311 | Uzatma Priz (Yaylı Kapaklı) | IP44 | 10   | 120  | 260,00 TL |
| BP1-1402-2413 | Makine Priz (Küçük Kapaklı) | IP44 | 10   | 120  | 150,00 TL |
| BP1-1402-2512 | Duvar Priz                  | IP44 | 6    | 72   | 241,00 TL |
| BP1-1402-2535 | 90° Eğik Duvar Priz         | IP44 | 4    | 48   | 311,00 TL |

| Ürün Kodu     | Açıklama                    | IP   | Kutu | Koli | Fiyat     |
|---------------|-----------------------------|------|------|------|-----------|
| BR1-1402-2711 | Ray Priz                    | IP20 | 12   | 144  | 220,00 TL |
| BR1-1402-2712 | Ray Priz (Led'li)           | IP20 | 12   | 144  | 270,00 TL |
| BR1-1402-2713 | Ray Priz (Fransız)          | IP20 | 12   | 144  | 270,00 TL |
| BR1-1402-2714 | Ray Priz (Fransız - Led'li) | IP20 | 12   | 144  | 323,00 TL |

| Ürün Kodu     | Açıklama            | IP   | Kutu | Koli | Fiyat     |
|---------------|---------------------|------|------|------|-----------|
| BP1-1402-2031 | UPS Düz Fiş         | IP44 | 35   | 420  | 92,00 TL  |
| BP1-1402-2042 | UPS Eğik Fiş        | IP44 | 35   | 420  | 92,00 TL  |
| BY2-1402-2011 | Düz Fiş (Mavi)      | IP44 | 35   | 420  | 93,00 TL  |
| BY2-1402-2031 | UPS Düz Fiş (Mavi)  | IP44 | 35   | 420  | 101,00 TL |
| BY5-1402-2011 | Düz Fiş (Gri)       | IP44 | 35   | 420  | 92,00 TL  |
| BY5-1402-2031 | UPS Düz Fiş (Gri)   | IP44 | 35   | 420  | 101,00 TL |
| BY2-1402-2022 | Eğik Fiş (Mavi)     | IP44 | 35   | 420  | 87,00 TL  |
| BY2-1402-2042 | UPS Eğik Fiş (Mavi) | IP44 | 35   | 420  | 98,00 TL  |

Not: Renkli ürünler siparişe göre üretilir.

## Özel Pano Prizler 1x16A. (2P+E) 200/250V.

| Ürün Kodu     | Açıklama   | IP   | Kutu | Koli | Fiyat     |
|---------------|--|------|------|------|-----------|
| BY8-1402-2446 | Hızlı Bağlantılı Somunlu Pano Priz (Çocuk Koruma Kilitli)              | IP44 | 30   | 360  | 103,00 TL |
| BY8-1402-2476 | Hızlı Bağlantılı Somunlu Pano Priz (Çocuk Koruma Kilitli)              | IP44 | 30   | 360  | 120,00 TL |
| BY8-1402-2447 | Fransız Tipi Hızlı Bağlantılı Somunlu Pano Priz (Çocuk Koruma Kilitli) | IP44 | 30   | 360  | 113,00 TL |
| BY8-1402-2477 | Fransız Tipi Hızlı Bağlantılı Somunlu Pano Priz (Çocuk Koruma Kilitli) | IP44 | 30   | 360  | 131,00 TL |



## Kauçuk Ark Kaynak 200A-400A

ERC  CE

| Ürün Kodu     | Açıklama                                | IP   | Kutu | Koli | Fiyat     |
|---------------|---|------|------|------|-----------|
| BK4-7501-2010 | 16/95mm <sup>2</sup> 200A. Fiş          | IP55 | 15   | 120  | 459,00 TL |
| BK4-7501-2310 | 16/95mm <sup>2</sup> 200A. Uzatma Priz  | IP55 | 15   | 120  | 471,00 TL |
| BK4-7501-2410 | 16/95mm <sup>2</sup> 200A. Makine Priz  | IP55 | 12   | 144  | 605,00 TL |
| BK4-9501-2010 | 50/150mm <sup>2</sup> 400A. Fiş         | IP55 | 15   | 120  | 520,00 TL |
| BK4-9501-2310 | 50/150mm <sup>2</sup> 400A. Uzatma Priz | IP55 | 15   | 120  | 581,00 TL |
| BK4-9501-2410 | 50/150mm <sup>2</sup> 400A. Makine Priz | IP55 | 12   | 144  | 673,00 TL |





IP54



KARAVAN TİPİ  
ENERJİ AKTARIM ÜNİTESİ  
KAPALI GÖRÜNÜMÜ



**BKT-0500-3000 (ABS)**  
3/16A. 220V. KAPAKLI FİŞ  
1.312,50 TL



**BKT-0002-3001 (ABS)**  
PANO PRİZLİ  
ÇAKMAKLIK + UYDU GİRİŞLİ  
1.375,00 TL



**BKT-3000-3000 (ABS)**  
BOŞ KASA  
1.125,00 TL



**BKT-0106-2000**  
(Polyamid 6)  
1/16A. UPS FİŞ - 3/16A. ADAPTÖR PRİZ  
585,00 TL



**BKT-0502-2000**  
(Polyamid 6)  
3/16A. FİŞ - 1/16A. ADAPTÖR PRİZ  
585,00 TL



**BC1-1402-2870**  
(Polyamid 6)  
3/16A. 220V. DÖNER PRİZ  
463,00 TL

*Kablolu seyyar uzatma ürünlerimiz kamp, tekne, karavanlarda kullanıma uygundur.*



*Kamp, karavan ve genel seyyar enerji aktarımı için tasarlanmış çeşitlerimiz. Bemis güvencesiyle TSE belgeli kablo bağlantılarında pabuç uygulanarak %100 test kontrollü üretilmektedir.*

*Amaç: Teknik adam saat ücretlerinin yükselmesi nedeniyle bu tür ürünlere ihtiyaç artmıştır. Bu ihtiyacı karşılamak amacıyla listemize eklenmiştir.*



## KARAVAN TİPİ KABLOLU ÜRÜNLER

| Ürün Kodu     | Açıklama  | IP   | Kutu | Koli | Fiyat      |
|---------------|---|------|------|------|------------|
| BKT-0102-8110 | 3x1,5 ttr 10mt Seyyar uzatma kablosu monofaze IP68 fiş ve uzatma priz | IP68 | 5    | 0    | FİYAT ALIN |
| BKT-0118-8110 | 3x2,5 ttr 10mt Tribox uzatma kablolu IP68 prizler ve fiş              | IP68 | 5    | 0    | FİYAT ALIN |
| BKT-0506-2205 | 3x2,5 ttr 5mt Seyyar uzatma kablosu Ceenorm 3/16A fiş ve uzatma priz  | IP44 | 5    | 0    | FİYAT ALIN |
| BKT-0506-2210 | 3x2,5 ttr 10mt Seyyar uzatma kablosu Ceenorm 3/16A fiş ve uzatma priz | IP44 | 5    | 0    | FİYAT ALIN |
| BKT-0708-2505 | 5x2,5 ttr 5mt Seyyar uzatma kablosu Ceenorm 5/16A fiş ve uzatma priz  | IP44 | 5    | 0    | FİYAT ALIN |
| BKT-0708-2510 | 5x2,5 ttr 10mt Seyyar uzatma kablosu Ceenorm 5/16A fiş ve uzatma priz | IP44 | 5    | 0    | FİYAT ALIN |
| BX1K7444-2100 | 5x2,5 ttr 2mt Polybox kablolu 5/16A fiş                               | IP44 | 1    | 0    | FİYAT ALIN |
| BX1K8222-2100 | 3x2,5 ttr 2mt Polybox kablolu 3/16A fiş                               | IP44 | 1    | 0    | FİYAT ALIN |

| Ürün Kodu     | Açıklama   | IP   | Kutu | Koli | Fiyat      |
|---------------|--|------|------|------|------------|
| BKT-0502-2200 | 3x2,5 ttr 1,5mt Karavan enerji kablosu 3/16A fiş -kauçuk uzatma priz                   | IP44 | 10   | 0    | FİYAT ALIN |
| BKT-0106-2200 | 3x2,5 ttr 1,5mt Karavan enerji kablosu 3/16A uzatma priz -kauçuk monofaze fiş          | IP44 | 10   | 0    | FİYAT ALIN |
| BKT-0102-2103 | 3x1,5 ttr 3mt Seyyar uzatma kablosu monofaze kauçuk fiş - monofaze kauçuk uzatma priz  | IP44 | 10   | 0    | FİYAT ALIN |
| BKT-0102-2105 | 3x1,5 ttr 5mt Seyyar uzatma kablosu monofaze kauçuk fiş - monofaze kauçuk uzatma priz  | IP44 | 10   | 0    | FİYAT ALIN |
| BKT-0102-2110 | 3x1,5 ttr 10mt Seyyar uzatma kablosu monofaze kauçuk fiş - monofaze kauçuk uzatma priz | IP44 | 5    | 0    | FİYAT ALIN |
| BKT-0118-2103 | 3x1,5 ttr 3mt Seyyar uzatma kablosu 3'lü priz IP54                                     | IP44 | 5    | 0    | FİYAT ALIN |
| BKT-0118-2105 | 3x1,5 ttr 5mt Seyyar uzatma kablosu 3'lü priz IP54                                     | IP44 | 5    | 0    | FİYAT ALIN |
| BKT-0118-2110 | 3x1,5 ttr 10mt Seyyar uzatma kablosu 3'lü priz IP54                                    | IP44 | 5    | 0    | FİYAT ALIN |



BKT-0502-2200



BKT-0106-2200



BKT-0102-2103



BKT-0102-2105



BKT-0102-2110



BKT-0118-2103



BKT-0118-2105



BKT-0118-2110



BKT-0102-8110



BKT-0118-8110



BKT-0506-2205



BKT-0506-2210



BKT-0708-2505



BKT-0708-2510



BX1K7444-2100



BX1K8222-2100

*Kalite saygının ifadesidir!..*

Bemis ürünleri montaj kolaylığı sayesinde tercih edilmektedir. Monofaze pano prizli tüm 90° eğik duvar prizlerimiz kablo bağlantıları yapılmış ve klemense toplanmıştır, bu uygulama 16A. / 32A. / 63A. / 125A. / 160A. duvar prizlerimizin tamamında uygulanmaktadır.

IP44



**BAĞLANTIYA HAZIR  
PRATİK ÜRÜN**

**5 YIL  
GARANTİ**

IP67

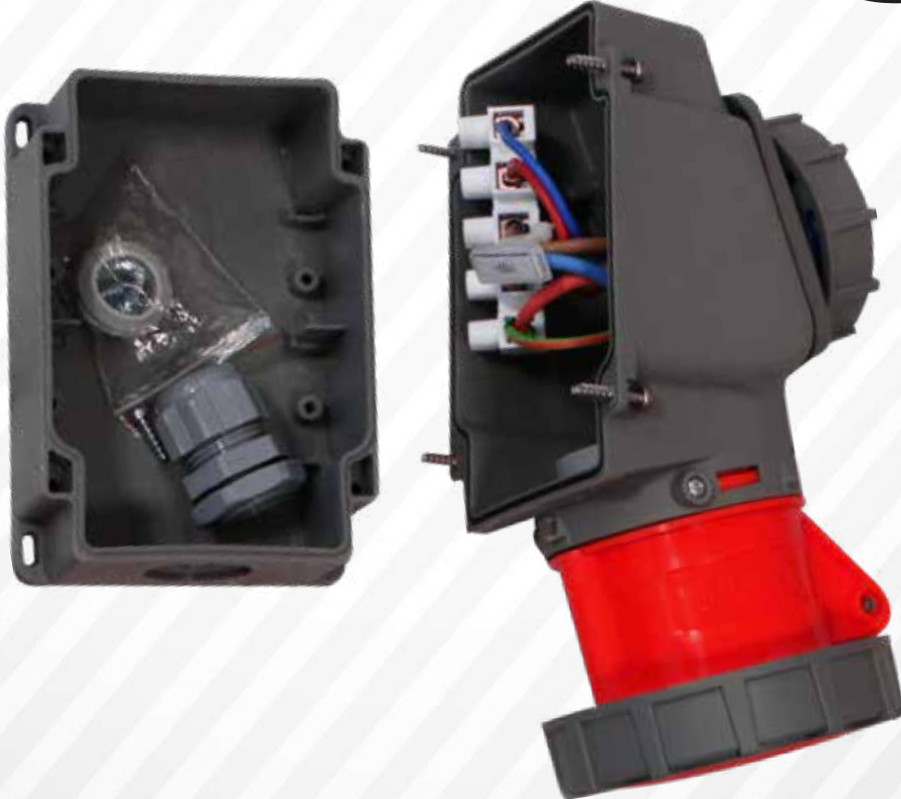

100  
yüzde  
yerli...

**B** bemis

5 YIL  
GARANTİ

**CEE Norm Fiş Priz Serisi**

16A - 32A - 63A - 125A - 160A

**YERLİ  
ÜRETİM**



Üreten Ülke Güçlüdür

CEE Norm



**16A - 32A**

**CEE Norm Fiş & Priz Serisi**



*Kalite saygının ifadesidir!..*

## CEE NORM

5/32A. (3P+E+N) 380/450V~



IP67

Ø8-18,5 kabloya uygun sabitleme rakoru

Koruma sınıfına uygun kapak tasarımı

Koruma kapağını tek elle açık tutma imkanı

850°C ısıya dayanıklı kontak taşıyıcı

Paslanmaz kilit mekanizması

Yüksek iletkenli MS58 kontak

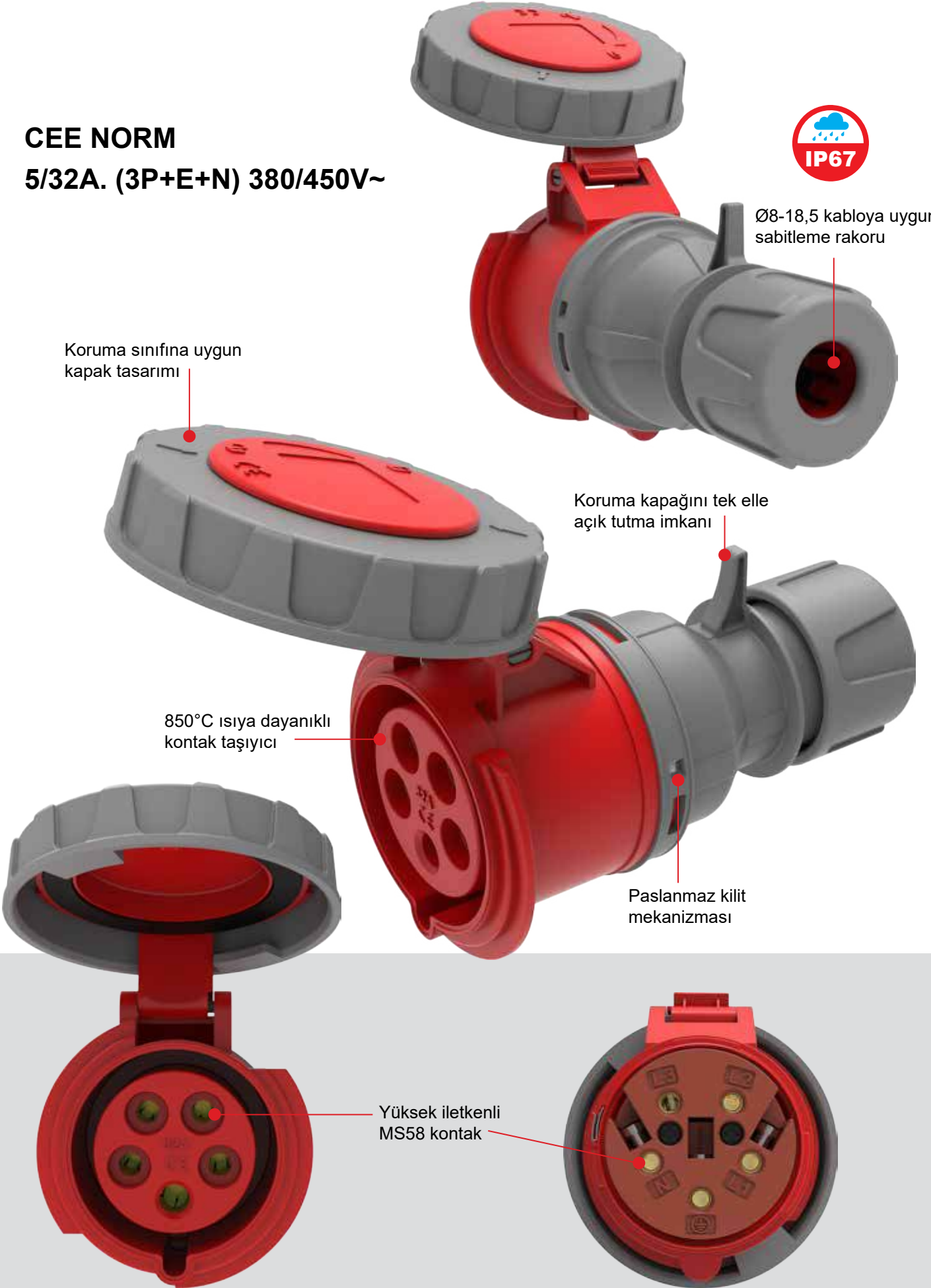



| Ürün Kodu     | Açıklama                                  | IP   | Kutu | Koli | Fiyat     |
|---------------|---|------|------|------|-----------|
| BC1-1303-2011 | 3/16A. Düz Fiş                            | IP44 | 10   | 120  | 234,00 TL |
| BC1-1303-2312 | 3/16A. Uzatma Priz                        | IP44 | 10   | 120  | 330,00 TL |
| BC1-1303-2413 | 3/16A. Makine Priz                        | IP44 | 15   | 120  | 326,00 TL |
| BC1-1303-2114 | 3/16A. Makine Fişi                        | IP44 | 10   | 120  | 326,00 TL |
| BC1-1303-2130 | 3/16A. 90° Eğik Döner Fiş                 | IP44 | 6    | 72   | 377,00 TL |
| BC1-1303-2210 | 3/16A. Duvar Fiş                          | IP44 | 6    | 72   | 416,00 TL |
| BC1-1303-2236 | 3/16A. 90° Eğik Duvar Fiş                 | IP44 | 6    | 48   | 539,00 TL |
| BC1-1303-2235 | 3/16A. 90° Eğik Duvar Fiş (Yaylı Kapaklı) | IP44 | 6    | 48   | 632,00 TL |
| BC1-1303-2420 | 3/16A. 45° Eğik Makine Priz               | IP44 | 8    | 96   | 326,00 TL |
| BC1-1303-2510 | 3/16A. Duvar Priz                         | IP44 | 6    | 72   | 427,00 TL |
| BC1-1303-2535 | 3/16A. 90° Eğik Duvar Priz                | IP44 | 3    | 36   | 578,00 TL |

| Ürün Kodu     | Açıklama                    | IP   | Kutu | Koli | Fiyat     |
|---------------|-----------------------------|------|------|------|-----------|
| BC1-1303-7011 | 3/16A. Düz Fiş              | IP67 | 8    | 96   | 362,00 TL |
| BC1-1303-7312 | 3/16A. Uzatma Priz          | IP67 | 8    | 96   | 468,00 TL |
| BC1-1303-7413 | 3/16A. Makine Priz          | IP67 | 8    | 96   | 462,00 TL |
| BC1-1303-7114 | 3/16A. Makine Fişi          | IP67 | 10   | 120  | 468,00 TL |
| BC1-1303-7210 | 3/16A. Duvar Fiş            | IP67 | 4    | 48   | 575,00 TL |
| BC1-1303-7236 | 3/16A. 90° Eğik Duvar Fiş   | IP67 | 3    | 36   | 700,00 TL |
| BC1-1303-7420 | 3/16A. 45° Eğik Makine Priz | IP67 | 6    | 72   | 462,00 TL |
| BC1-1303-7510 | 3/16A. Duvar Priz           | IP67 | 4    | 48   | 670,00 TL |
| BC1-1303-7535 | 3/16A. 90° Eğik Duvar Priz  | IP67 | 3    | 36   | 720,00 TL |



## 3 Kontaklı CEE Norm Seri



**3/16A. (2P+E)**  
220V. 50/60 Hz. 6h  
(Polyamid 6)



| Ürün Kodu     | Açıklama                                  | IP   | Kutu | Koli | Fiyat     |
|---------------|---|------|------|------|-----------|
| BC1-1403-2011 | 3/16A. Düz Fiş                            | IP44 | 10   | 120  | 203,00 TL |
| BC1-1403-2312 | 3/16A. Uzatma Priz                        | IP44 | 10   | 120  | 267,00 TL |
| BC1-1403-2413 | 3/16A. Makine Priz                        | IP44 | 15   | 120  | 250,00 TL |
| BC1-1403-2114 | 3/16A. Makine Fişi                        | IP44 | 10   | 120  | 250,00 TL |
| BC1-1403-2130 | 3/16A. 90° Eğik Döner Fiş                 | IP44 | 6    | 72   | 324,00 TL |
| BC1-1403-2210 | 3/16A. Duvar Fiş                          | IP44 | 6    | 72   | 369,00 TL |
| BC1-1403-2236 | 3/16A. 90° Eğik Duvar Fiş                 | IP44 | 6    | 48   | 441,00 TL |
| BC1-1403-2235 | 3/16A. 90° Eğik Duvar Fiş (Yaylı Kapaklı) | IP44 | 6    | 48   | 530,00 TL |
| BC1-1403-2535 | 3/16A. 90° Eğik Duvar Priz                | IP44 | 3    | 36   | 463,00 TL |
| BC1-1403-2420 | 3/16A. 45° Eğik Makine Priz               | IP44 | 8    | 96   | 250,00 TL |
| BC1-1403-2510 | Duvar Priz                                | IP44 | 6    | 72   | 369,00 TL |



| Ürün Kodu     | Açıklama                    | IP   | Kutu | Koli | Fiyat     |
|---------------|-----------------------------|------|------|------|-----------|
| BC1-1403-7011 | 3/16A. Düz Fiş              | IP67 | 8    | 96   | 328,00 TL |
| BC1-1403-7312 | 3/16A. Uzatma Priz          | IP67 | 8    | 96   | 430,00 TL |
| BC1-1403-7413 | 3/16A. Makine Priz          | IP67 | 8    | 96   | 406,00 TL |
| BC1-1403-7114 | 3/16A. Makine Fişi          | IP67 | 10   | 120  | 406,00 TL |
| BC1-1403-7210 | 3/16A. Duvar Fiş            | IP67 | 4    | 48   | 528,00 TL |
| BC1-1403-7236 | 3/16A. 90° Eğik Duvar Fiş   | IP67 | 3    | 36   | 629,00 TL |
| BC1-1403-7420 | 3/16A. 45° Eğik Makine Priz | IP67 | 6    | 72   | 406,00 TL |
| BC1-1403-7510 | 3/16A. Duvar Priz           | IP67 | 4    | 48   | 615,00 TL |
| BC1-1403-7535 | 3/16A. 90° Eğik Duvar Priz  | IP67 | 3    | 36   | 665,00 TL |

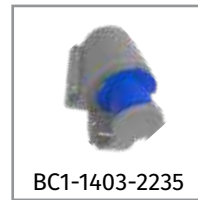



| Ürün Kodu     | Açıklama                                  | IP   | Kutu | Koli | Fiyat     |
|---------------|---|------|------|------|-----------|
| BC1-1504-2011 | 4/16A. Düz Fiş                            | IP44 | 8    | 96   | 255,00 TL |
| BC1-1504-2312 | 4/16A. Uzatma Priz                        | IP44 | 8    | 96   | 322,00 TL |
| BC1-1504-2413 | 4/16A. Makine Priz                        | IP44 | 15   | 120  | 295,00 TL |
| BC1-1504-2114 | 4/16A. Makine Fişi                        | IP44 | 10   | 120  | 295,00 TL |
| BC1-1504-2130 | 4/16A. 90° Eğik Döner Fiş                 | IP44 | 6    | 72   | 359,00 TL |
| BC1-1504-2210 | 4/16A. Duvar Fiş                          | IP44 | 6    | 72   | 388,00 TL |
| BC1-1504-2235 | 4/16A. 90° Eğik Duvar Fiş (Yaylı Kapaklı) | IP44 | 6    | 48   | 554,00 TL |
| BC1-1504-2236 | 4/16A. 90° Eğik Duvar Fiş                 | IP44 | 6    | 48   | 396,00 TL |
| BC1-1504-2420 | 4/16A. 45° Eğik Makine Priz               | IP44 | 8    | 96   | 295,00 TL |
| BC1-1504-2510 | 4/16A. Duvar Priz                         | IP44 | 6    | 72   | 394,00 TL |
| BC1-1504-2535 | 4/16A. 90° Eğik Duvar Priz                | IP44 | 3    | 36   | 487,00 TL |
| BR1-1504-2711 | Ray Priz                                  | IP20 | 6    | 72   | 437,00 TL |

| Ürün Kodu     | Açıklama                    | IP   | Kutu | Koli | Fiyat     |
|---------------|-----------------------------|------|------|------|-----------|
| BC1-1504-7011 | 4/16A. Düz Fiş              | IP67 | 6    | 72   | 363,00 TL |
| BC1-1504-7312 | 4/16A. Uzatma Priz          | IP67 | 6    | 72   | 502,00 TL |
| BC1-1504-7114 | 4/16A. Makine Fişi          | IP67 | 10   | 120  | 485,00 TL |
| BC1-1504-7210 | 4/16A. Duvar Fiş            | IP67 | 4    | 48   | 542,00 TL |
| BC1-1504-7236 | 4/16A. 90° Eğik Duvar Fiş   | IP67 | 3    | 36   | 716,00 TL |
| BC1-1504-7413 | 4/16A. Makine Priz          | IP67 | 6    | 72   | 485,00 TL |
| BC1-1504-7420 | 4/16A. 45° Eğik Makine Priz | IP67 | 6    | 72   | 485,00 TL |
| BC1-1504-7510 | 4/16A. Duvar Priz           | IP67 | 4    | 48   | 635,00 TL |
| BC1-1504-7535 | 4/16A. 90° Eğik Duvar Priz  | IP67 | 3    | 36   | 669,00 TL |







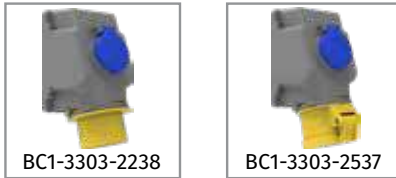
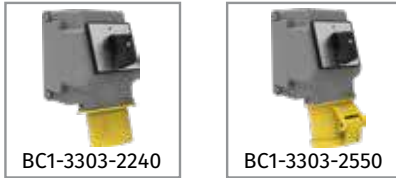
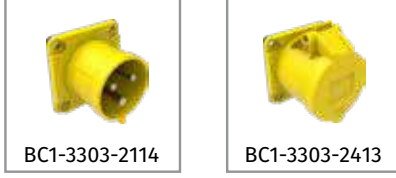

| Ürün Kodu     | Açıklama                                  | IP   | Kutu | Koli | Fiyat       |
|---------------|---|------|------|------|-------------|
| BC1-3303-2011 | 3/32A. Düz Fiş                            | IP44 | 8    | 64   | 384,00 TL   |
| BC1-3303-2312 | 3/32A. Uzatma Priz                        | IP44 | 8    | 64   | 468,00 TL   |
| BC1-3303-2413 | 3/32A. Makine Priz (75x75)                | IP44 | 8    | 64   | 422,00 TL   |
| BC1-3303-2114 | 3/32A. Makine Fişi                        | IP44 | 8    | 96   | 422,00 TL   |
| BC1-3303-2140 | 3/32A. Somunlu Fiş                        | IP44 | 8    | 64   | 422,00 TL   |
| BC1-3303-2130 | 3/32A. 90° Eğik Döner Fiş                 | IP44 | 6    | 72   | 478,00 TL   |
| BC1-3303-2210 | 3/32A. Duvar Fiş                          | IP44 | 6    | 72   | 635,00 TL   |
| BC1-3303-2236 | 3/32A. 90° Eğik Duvar Fiş                 | IP44 | 3    | 36   | 639,00 TL   |
| BC1-3303-2235 | 3/32A. 90° Eğik Duvar Fiş (Yaylı Kapaklı) | IP44 | 3    | 36   | 773,00 TL   |
| BC1-3303-2238 | 3/32A. 90° Eğik P. Prizli Duvar Fiş       | IP44 | 3    | 24   | 1.119,00 TL |
| BC1-3303-2240 | 3/32A. Pako Şalterli 90° Eğik Duvar Fiş   | IP44 | 1    | 12   | 2.127,00 TL |
| BC1-3303-2440 | 3/32A. Somunlu Priz                       | IP44 | 8    | 64   | 422,00 TL   |
| BC1-3303-2510 | 3/32A. Duvar Priz                         | IP44 | 6    | 72   | 657,00 TL   |
| BC1-3303-2535 | 3/32A. 90° Eğik Duvar Priz                | IP44 | 3    | 36   | 700,00 TL   |
| BC1-3303-2537 | 3/32A. 90° Eğik P. Prizli Duvar Priz      | IP44 | 3    | 24   | 1.174,00 TL |
| BC1-3303-2550 | 3/32A. Pako Şalterli 90° Eğik Duvar Priz  | IP44 | 1    | 12   | 2.172,00 TL |

| Ürün Kodu     | Açıklama                                | IP   | Kutu | Koli | Fiyat       |
|---------------|---|------|------|------|-------------|
| BC1-3303-7011 | 3/32A. Düz Fiş                          | IP67 | 3    | 36   | 536,00 TL   |
| BC1-3303-7312 | 3/32A. Uzatma Priz                      | IP67 | 3    | 36   | 677,00 TL   |
| BC1-3303-7413 | 3/32A. Makine Priz (75x75)              | IP67 | 4    | 48   | 635,00 TL   |
| BC1-3303-7114 | 3/32A. Makine Fişi (83x90)              | IP67 | 6    | 72   | 635,00 TL   |
| BC1-3303-7210 | 3/32A. Duvar Fiş                        | IP67 | 2    | 16   | 740,00 TL   |
| BC1-3303-7236 | 3/32A. 90° Eğik Duvar Fiş               | IP67 | 3    | 36   | 862,00 TL   |
| BC1-3303-7238 | 3/32A. 90° Eğik Mak. Prizli Duvar Fişi  | IP67 | 1    | 12   | 1.336,00 TL |
| BC1-3303-7440 | 3/32A. Somunlu Priz                     | IP67 | 4    | 48   | 635,00 TL   |
| BC1-3303-7510 | 3/32A. Duvar Priz                       | IP67 | 2    | 24   | 776,00 TL   |
| BC1-3303-7535 | 3/32A. 90° Eğik Duvar Priz              | IP67 | 3    | 36   | 806,00 TL   |
| BC1-3303-7537 | 3/32A. 90° Eğik Mak. Prizli Duvar Prizi | IP67 | 1    | 12   | 1.353,00 TL |



### 3 Kontaklı CEE Norm Seri



**3/32A. (2P+E)**  
220V. 50/60 Hz. 6h  
(Polyamid 6)



| Ürün Kodu     | Açıklama                                  | IP   | Kutu | Koli | Fiyat       |
|---------------|---|------|------|------|-------------|
| BC1-3403-2011 | 3/32A. Düz Fiş                            | IP44 | 8    | 64   | 327,00 TL   |
| BC1-3403-2312 | 3/32A. Uzatma Priz                        | IP44 | 8    | 64   | 398,00 TL   |
| BC1-3403-2413 | 3/32A. Makine Priz (75x75)                | IP44 | 8    | 64   | 365,00 TL   |
| BC1-3403-2114 | 3/32A. Makine Fişi                        | IP44 | 8    | 96   | 365,00 TL   |
| BC1-3403-2140 | 3/32A. Somunlu Fiş                        | IP44 | 8    | 64   | 388,00 TL   |
| BC1-3403-2130 | 3/32A. 90° Eğik Döner Fiş                 | IP44 | 6    | 72   | 433,00 TL   |
| BC1-3403-2210 | 3/32A. Duvar Fiş                          | IP44 | 6    | 72   | 508,00 TL   |
| BC1-3403-2236 | 3/32A. 90° Eğik Duvar Fiş                 | IP44 | 3    | 36   | 536,00 TL   |
| BC1-3403-2235 | 3/32A. 90° Eğik Duvar Fiş (Yaylı Kapaklı) | IP44 | 3    | 36   | 670,00 TL   |
| BC1-3403-2238 | 3/32A. 90° Eğik P. Prizli Duvar Fiş       | IP44 | 3    | 24   | 1.080,00 TL |
| BC1-3403-2240 | 3/32A. Pako Şalterli 90° Eğik Duvar Fiş   | IP44 | 1    | 12   | 2.137,00 TL |
| BC1-3403-2420 | 3/32A. 45° Eğik Makine Priz               | IP44 | 4    | 48   | 365,00 TL   |
| BC1-3403-2440 | 3/32A. Somunlu Priz                       | IP44 | 8    | 64   | 365,00 TL   |
| BC1-3403-2510 | 3/32A. Duvar Priz                         | IP44 | 6    | 72   | 530,00 TL   |
| BC1-3403-2535 | 3/32A. 90° Eğik Duvar Priz                | IP44 | 3    | 36   | 605,00 TL   |
| BC1-3403-2537 | 3/32A. 90° Eğik P. Prizli Duvar Priz      | IP44 | 3    | 24   | 1.175,00 TL |
| BC1-3403-2550 | 3/32A. Pako Şalterli 90° Eğik Duvar Priz  | IP44 | 1    | 12   | 2.183,00 TL |

| Ürün Kodu     | Açıklama                                | IP   | Kutu | Koli | Fiyat       |
|---------------|---|------|------|------|-------------|
| BC1-3403-7011 | 3/32A. Düz Fiş                          | IP67 | 3    | 36   | 454,00 TL   |
| BC1-3403-7312 | 3/32A. Uzatma Priz                      | IP67 | 3    | 36   | 576,00 TL   |
| BC1-3403-7413 | 3/32A. Makine Priz (75x75)              | IP67 | 4    | 48   | 525,00 TL   |
| BC1-3403-7114 | 3/32A. Makine Fişi (83x90)              | IP67 | 6    | 72   | 525,00 TL   |
| BC1-3403-7210 | 3/32A. Duvar Fiş                        | IP67 | 2    | 16   | 700,00 TL   |
| BC1-3403-7236 | 3/32A. 90° Eğik Duvar Fiş               | IP67 | 3    | 36   | 736,00 TL   |
| BC1-3403-7238 | 3/32A. 90° Eğik Mak. Prizli Duvar Fişi  | IP67 | 1    | 12   | 1.332,00 TL |
| BC1-3403-7420 | 3/32A. 45° Eğik Makine Priz             | IP67 | 4    | 48   | 525,00 TL   |
| BC1-3403-7440 | 3/32A. Somunlu Priz                     | IP67 | 4    | 48   | 525,00 TL   |
| BC1-3403-7510 | 3/32A. Duvar Priz                       | IP67 | 2    | 24   | 659,00 TL   |
| BC1-3403-7535 | 3/32A. 90° Eğik Duvar Priz              | IP67 | 3    | 36   | 740,00 TL   |
| BC1-3403-7537 | 3/32A. 90° Eğik Mak. Prizli Duvar Prizi | IP67 | 1    | 12   | 1.409,00 TL |



BC1-3403-2011



BC1-3403-2312



BC1-3403-2114



BC1-3403-2413



BC1-3403-2140



BC1-3403-2440



BC1-3403-2210



BC1-3403-2510



BC1-3403-2130



BC1-3403-2235



BC1-3403-2240



BC1-3403-2550



BC1-3403-2238



BC1-3403-2537



BC1-3403-2236



BC1-3403-2535



BC1-3403-7114



BC1-3403-7238



BC1-3403-7210



BC1-3403-7236



BC1-3403-7011



BC1-3403-7312



BC1-3403-7413



BC1-3403-7440



BC1-3403-7510



BC1-3403-7535

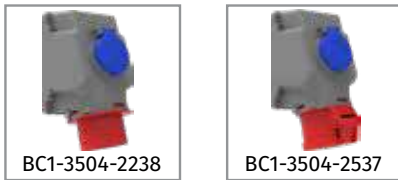
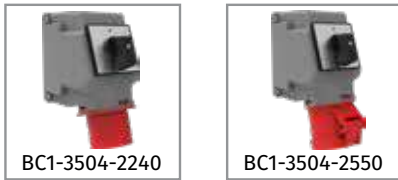
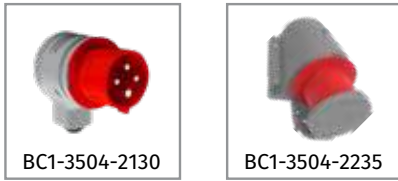
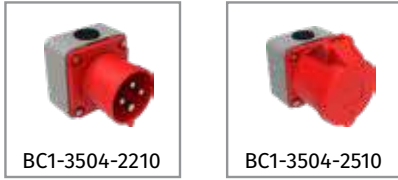

| Ürün Kodu     | Açıklama                                  | IP   | Kutu | Koli | Fiyat       |
|---------------|---|------|------|------|-------------|
| BC1-3504-2011 | 4/32A. Düz Fiş                            | IP44 | 8    | 64   | 340,00 TL   |
| BC1-3504-2312 | 4/32A. Uzatma Priz                        | IP44 | 8    | 64   | 446,00 TL   |
| BC1-3504-2413 | 4/32A. Makine Priz (75x75)                | IP44 | 8    | 64   | 408,00 TL   |
| BC1-3504-2114 | 4/32A. Makine Fişi                        | IP44 | 8    | 96   | 408,00 TL   |
| BC1-3504-2140 | 4/32A. Somunlu Fiş                        | IP44 | 8    | 64   | 442,00 TL   |
| BC1-3504-2130 | 4/32A. 90° Eğik Döner Fiş                 | IP44 | 6    | 72   | 530,00 TL   |
| BC1-3504-2210 | 4/32A. Duvar Fiş                          | IP44 | 6    | 72   | 500,00 TL   |
| BC1-3504-2236 | 4/32A. 90° Eğik Duvar Fiş                 | IP44 | 3    | 36   | 602,00 TL   |
| BC1-3504-2235 | 4/32A. 90° Eğik Duvar Fiş (Yaylı Kapaklı) | IP44 | 3    | 36   | 736,00 TL   |
| BC1-3504-2238 | 4/32A. 90° Eğik P. Prizli Duvar Fiş       | IP44 | 3    | 24   | 1.289,00 TL |
| BC1-3504-2240 | 4/32A. Pako Şalterli 90° Eğik Duvar Fiş   | IP44 | 1    | 12   | 3.069,00 TL |
| BC1-3504-2420 | 4/32A. 45° Eğik Makine Priz               | IP44 | 4    | 48   | 408,00 TL   |
| BC1-3504-2440 | 4/32A. Somunlu Priz                       | IP44 | 8    | 64   | 408,00 TL   |
| BC1-3504-2510 | 4/32A. Duvar Priz                         | IP44 | 6    | 72   | 546,00 TL   |
| BC1-3504-2535 | 4/32A. 90° Eğik Duvar Priz                | IP44 | 3    | 36   | 641,00 TL   |
| BC1-3504-2537 | 4/32A. 90° Eğik P. Prizli Duvar Priz      | IP44 | 3    | 24   | 1.348,00 TL |
| BC1-3504-2550 | 4/32A. Pako Şalterli 90° Eğik Duvar Priz  | IP44 | 1    | 12   | 3.109,00 TL |

| Ürün Kodu     | Açıklama                             | IP   | Kutu | Koli | Fiyat       |
|---------------|--------------------------------------|------|------|------|-------------|
| BC1-3504-7011 | 4/32A. Düz Fiş                       | IP67 | 3    | 36   | 504,00 TL   |
| BC1-3504-7312 | 4/32A. Uzatma Priz                   | IP67 | 3    | 36   | 611,00 TL   |
| BC1-3504-7413 | 4/32A. Makine Priz (75x75)           | IP67 | 4    | 48   | 567,00 TL   |
| BC1-3504-7114 | 4/32A. Makine Fişi (83x90)           | IP67 | 6    | 72   | 567,00 TL   |
| BC1-3504-7210 | 4/32A. Duvar Fiş                     | IP67 | 2    | 16   | 746,00 TL   |
| BC1-3504-7236 | 4/32A. 90° Eğik Duvar Fiş            | IP67 | 3    | 36   | 835,00 TL   |
| BC1-3504-7238 | 4/32A. 90° Eğik M. Prizli Duvar Fiş  | IP67 | 1    | 12   | 1.513,00 TL |
| BC1-3504-7420 | 4/32A. 45° Eğik Makine Priz          | IP67 | 4    | 48   | 567,00 TL   |
| BC1-3504-7440 | 4/32A. Somunlu Priz                  | IP67 | 4    | 48   | 567,00 TL   |
| BC1-3504-7510 | 4/32A. Duvar Priz                    | IP67 | 2    | 24   | 695,00 TL   |
| BC1-3504-7535 | 4/32A. 90° Eğik Duvar Priz           | IP67 | 3    | 36   | 829,00 TL   |
| BC1-3504-7537 | 4/32A. 90° Eğik M. Prizli Duvar Priz | IP67 | 1    | 12   | 1.614,00 TL |

**Not: İsteğe bağlı olarak 3h CEE Norm seri üretilebilmektedir.**

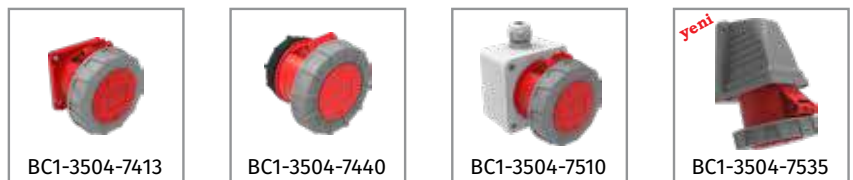

## 5 Kontaklı CEE Norm Serisi



**5/32A. (3P+E+N)**  
380V. 50/60 Hz. 6h  
(Polyamid 6)



| Ürün Kodu     | Açıklama   | IP   | Kutu | Koli | Fiyat       |
|---------------|--|------|------|------|-------------|
| BC1-3505-2011 | 5/32A. Düz Fiş                                     | IP44 | 8    | 64   | 391,00 TL   |
| BC1-3505-2312 | 5/32A. Uzatma Priz                                 | IP44 | 8    | 64   | 480,00 TL   |
| BC1-3505-2413 | 5/32A. Makine Priz (75x75)                         | IP44 | 8    | 64   | 459,00 TL   |
| BC1-3505-2114 | 5/32A. Makine Fişi                                 | IP44 | 8    | 96   | 459,00 TL   |
| BC1-3505-2140 | 5/32A. Somunlu Fiş                                 | IP44 | 8    | 64   | 459,00 TL   |
| BC1-3505-2130 | 5/32A. 90° Eğik Döner Fiş                          | IP44 | 6    | 72   | 493,00 TL   |
| BC1-3505-2210 | 5/32A. Duvar Fiş                                   | IP44 | 6    | 72   | 557,00 TL   |
| BC1-3505-2236 | 5/32A. 90° Eğik Duvar Fiş                          | IP44 | 3    | 36   | 635,00 TL   |
| BC1-3505-2235 | 5/32A. 90° Eğik Duvar Fiş (Yaylı Kapaklı)          | IP44 | 3    | 36   | 769,00 TL   |
| BC1-3505-2238 | 5/32A. 90° Eğik P. Prizli Duvar Fiş                | IP44 | 3    | 24   | 1.322,00 TL |
| BC1-3505-2240 | 5/32A. Pako Şalterli 90° Eğik Duvar Fiş            | IP44 | 1    | 12   | 3.172,00 TL |
| BC1-3505-2420 | 5/32A. 45° Eğik Makine Priz                        | IP44 | 6    | 72   | 459,00 TL   |
| BC1-3505-2440 | 5/32A. Somunlu Priz                                | IP44 | 8    | 64   | 459,00 TL   |
| BC1-3505-2510 | 5/32A. Duvar Priz                                  | IP44 | 6    | 72   | 560,00 TL   |
| BC1-3505-2535 | 5/32A. 90° Eğik Duvar Priz                         | IP44 | 3    | 36   | 700,00 TL   |
| BC1-3505-2537 | 5/32A. 90° Eğik P. Prizli Duvar Priz               | IP44 | 3    | 24   | 1.423,00 TL |
| BC1-3505-2550 | 5/32A. Pako Şalterli 90° Eğik Duvar Priz           | IP44 | 1    | 12   | 3.212,00 TL |
| BC1-3505-2050 | 5/32A. Enversör Düz Fiş                            | IP44 | 8    | 64   | 746,00 TL   |
| BC1-3505-2060 | 5/32A. 90° Eğik Enversör Duvar Fiş                 | IP44 | 3    | 36   | 955,00 TL   |
| BC1-3505-2061 | 5/32A. 90° Eğik Enversör Duvar Fiş (Yaylı Kapaklı) | IP44 | 3    | 36   | 1.089,00 TL |
| BC1-3505-2070 | 5/32A. Enversör Makine Fişi                        | IP44 | 8    | 96   | 806,00 TL   |
| BC1-3505-2080 | 5/32A. 90° Eğik Enversör Döner Fiş                 | IP44 | 6    | 72   | 746,00 TL   |



| Ürün Kodu     | Açıklama                                       | IP   | Kutu | Koli | Fiyat       |
|---------------|--|------|------|------|-------------|
| BC1-3505-7011 | 5/32A. Düz Fiş                                 | IP67 | 3    | 36   | 530,00 TL   |
| BC1-3505-7312 | 5/32A. Uzatma Priz                             | IP67 | 3    | 36   | 659,00 TL   |
| BC1-3505-7413 | 5/32A. Makine Priz (75x75)                     | IP67 | 4    | 48   | 614,00 TL   |
| BC1-3505-7114 | 5/32A. Makine Fişi (83x90)                     | IP67 | 6    | 72   | 614,00 TL   |
| BC1-3505-7210 | 5/32A. Duvar Fişi                              | IP67 | 2    | 16   | 791,00 TL   |
| BC1-3505-7236 | 5/32A. 90° Eğik Duvar Fiş                      | IP67 | 3    | 36   | 884,00 TL   |
| BC1-3505-7238 | 5/32A. 90° Eğik 1/16A. Mak. Prizli Duvar Fişi  | IP67 | 1    | 12   | 1.638,00 TL |
| BC1-3505-7420 | 5/32A. 45° Eğik Makine Priz                    | IP67 | 4    | 48   | 614,00 TL   |
| BC1-3505-7440 | 5/32A. Somunlu Priz                            | IP67 | 4    | 48   | 614,00 TL   |
| BC1-3505-7510 | 5/32A. Duvar Priz                              | IP67 | 2    | 24   | 735,00 TL   |
| BC1-3505-7535 | 5/32A. 90° Eğik Duvar Priz                     | IP67 | 3    | 36   | 862,00 TL   |
| BC1-3505-7537 | 5/32A. 90° Eğik 1/16A. Mak. Prizli Duvar Prizi | IP67 | 1    | 12   | 1.679,00 TL |
| BC1-3505-7050 | 5/32A. Enversör Düz Fiş                        | IP67 | 3    | 36   | 1.044,00 TL |
| BC1-3505-7060 | 5/32A. 90° Eğik Enversör Duvar Fiş             | IP67 | 3    | 36   | 1.313,00 TL |
| BC1-3505-7070 | 5/32A. Enversör Makine Fişi                    | IP67 | 6    | 72   | 1.082,00 TL |



**B** bemis

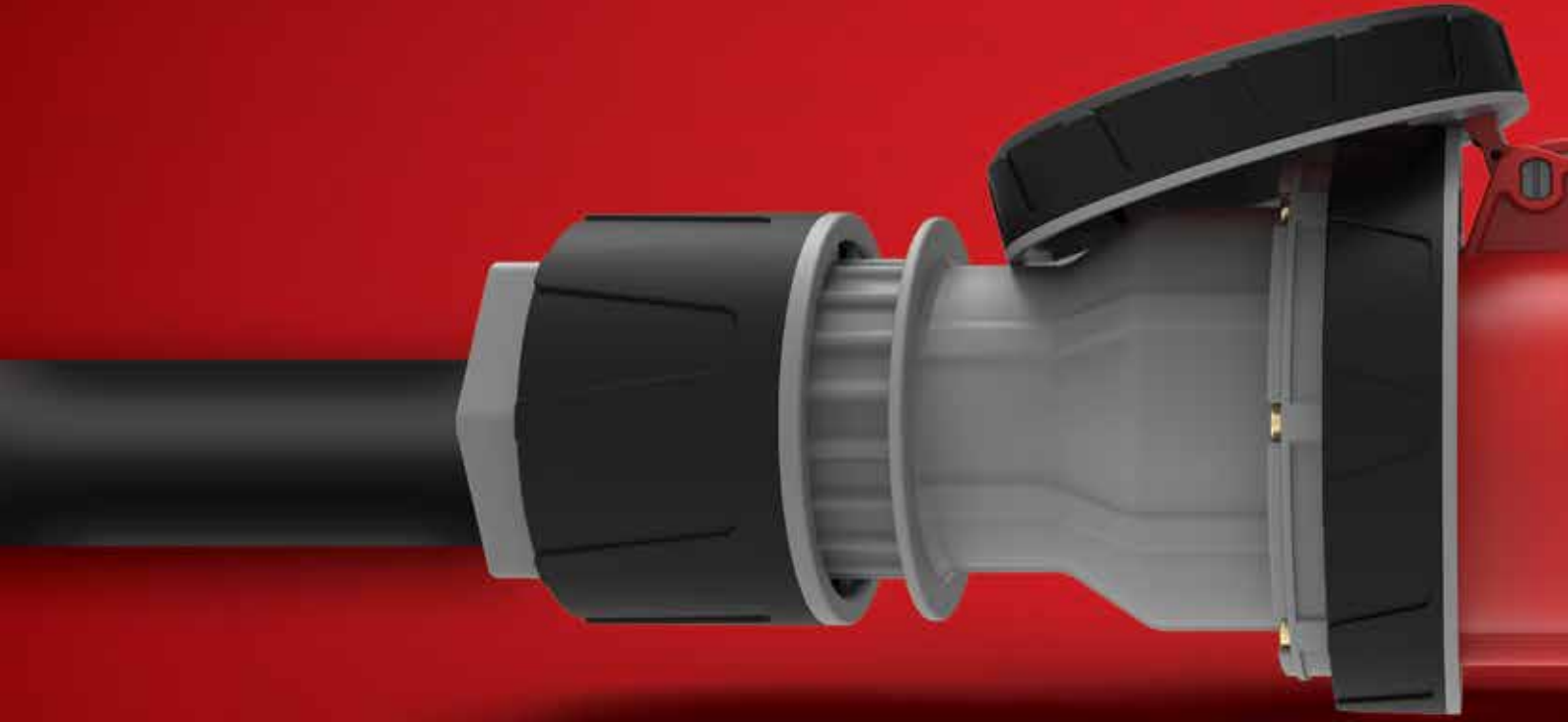

*Kalite saygının ifadesidir!..*

**63A - 125A - 160A**

*CEE Norm RS Serisi Fiş & Priz*

**RS**

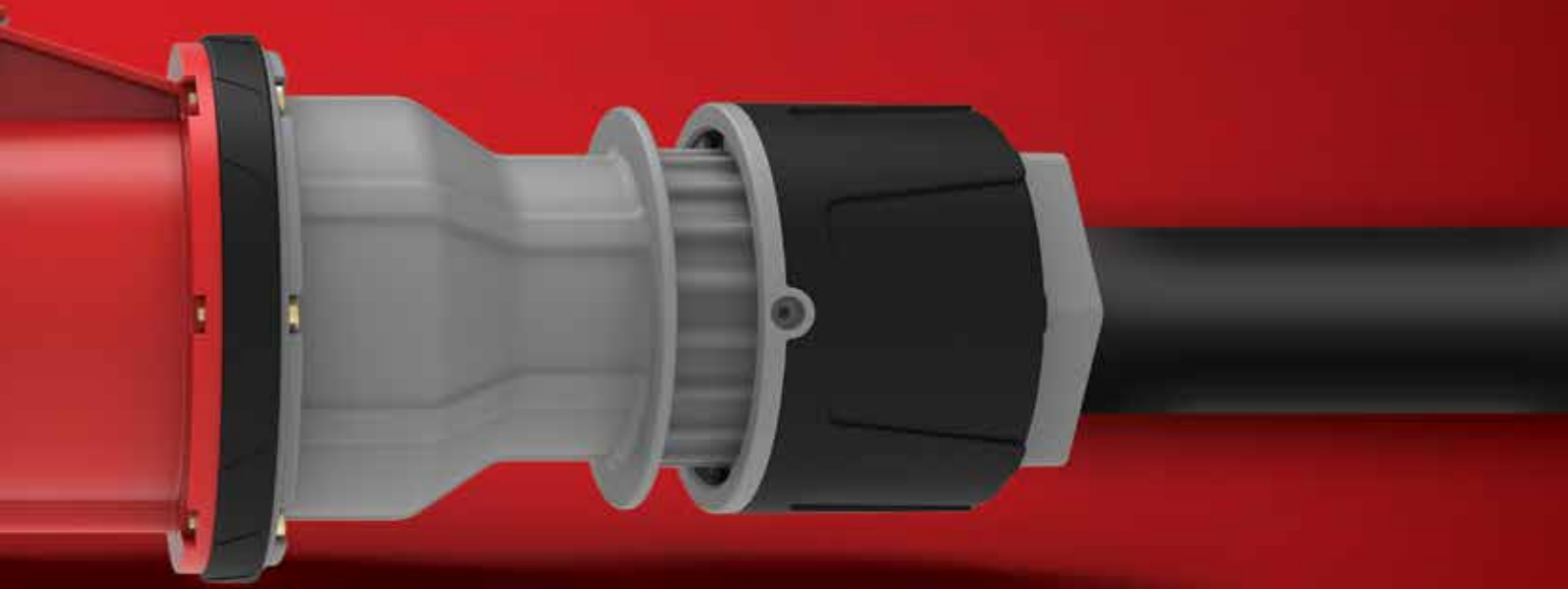



| Ürün Kodu     | Açıklama                                 | IP   | Kutu | Koli | Fiyat       |
|---------------|--|------|------|------|-------------|
| BC1-4303-2011 | 3/63A. Düz Fiş                           | IP44 | 1    | 12   | 1.313,00 TL |
| BC1-4303-2312 | 3/63A. Uzatma Priz                       | IP44 | 1    | 12   | 1.894,00 TL |
| BC1-4303-2413 | 3/63A. Makine Priz                       | IP44 | 1    | 24   | 1.350,00 TL |
| BC1-4303-2114 | 3/63A. Makine Fişi                       | IP44 | 1    | 24   | 1.350,00 TL |
| BC1-4303-2420 | 3/63A. 45° Eğik Makine Priz              | IP44 | 1    | 24   | 1.350,00 TL |
| BC1-4303-2510 | 3/63A. Duvar Priz                        | IP44 | 1    | 8    | 1.693,00 TL |
| BC1-4303-2535 | 3/63A. 90° Eğik Duvar Priz               | IP44 | 1    | 7    | 2.067,00 TL |
| BC1-4303-2537 | 3/63A. 90° Eğik P. Prizli Duvar Priz     | IP44 | 1    | 7    | 2.320,00 TL |
| BC1-4303-2210 | 3/63A. Duvar Fiş                         | IP44 | 1    | 8    | 1.611,00 TL |
| BC1-4303-2236 | 3/63A. 90° Eğik Duvar Fiş                | IP44 | 1    | 7    | 1.879,00 TL |
| BC1-4303-2238 | 3/63A. 90° Eğik P. Prizli Duvar Fiş      | IP44 | 1    | 7    | 2.148,00 TL |
| BC1-4303-2240 | 3/63A. 90° Eğik Pako Şalterli Duvar Fiş  | IP44 | 1    | 7    | 3.414,00 TL |
| BC1-4303-2550 | 3/63A. 90° Eğik Pako Şalterli Duvar Priz | IP44 | 1    | 7    | 3.509,00 TL |

| Ürün Kodu     | Açıklama                                      | IP   | Kutu | Koli | Fiyat       |
|---------------|---|------|------|------|-------------|
| BC1-4303-7011 | 3/63A. Düz Fiş                                | IP67 | 1    | 12   | 1.388,00 TL |
| BC1-4303-7312 | 3/63A. Uzatma Priz                            | IP67 | 1    | 12   | 2.014,00 TL |
| BC1-4303-7413 | 3/63A. Makine Priz                            | IP67 | 1    | 24   | 1.522,00 TL |
| BC1-4303-7114 | 3/63A. Makine Fişi                            | IP67 | 1    | 24   | 1.522,00 TL |
| BC1-4303-7420 | 3/63A. 45° Eğik Makine Priz                   | IP67 | 1    | 24   | 1.522,00 TL |
| BC1-4303-7510 | 3/63A. Duvar Priz                             | IP67 | 1    | 8    | 1.858,00 TL |
| BC1-4303-7535 | 3/63A. 90° Eğik Duvar Priz                    | IP67 | 1    | 7    | 2.148,00 TL |
| BC1-4303-7537 | 3/63A. 90° Eğik 1/16A. Mak. Prizli Duvar Priz | IP67 | 1    | 7    | 2.417,00 TL |
| BC1-4303-7210 | 3/63A. Duvar Fiş                              | IP67 | 1    | 8    | 1.790,00 TL |
| BC1-4303-7236 | 3/63A. 90° Eğik Duvar Fiş                     | IP67 | 1    | 7    | 2.133,00 TL |
| BC1-4303-7238 | 3/63A. 90° Eğik 1/16A. Mak. Prizli Duvar Fiş  | IP67 | 1    | 7    | 2.357,00 TL |
| BC1-4303-7240 | 3/63A. 90° Eğik Pako Şalterli Duvar Fiş       | IP65 | 1    | 7    | 3.663,00 TL |
| BC1-4303-7550 | 3/63A. 90° Eğik Pako Şalterli Duvar Priz      | IP65 | 1    | 7    | 3.759,00 TL |





### 3 Kontaklı CEE Norm Seri



**3/63A. (2P+E) PİLOTLU**  
110V. 50/60 Hz. 4h  
(Polyamid 6)



| Ürün Kodu     | Açıklama                                 | IP   | Kutu | Koli | Fiyat       |
|---------------|--|------|------|------|-------------|
| BC3-4303-2011 | 3/63A. Düz Fiş                           | IP44 | 1    | 12   | 1.388,00 TL |
| BC3-4303-2312 | 3/63A. Uzatma Priz                       | IP44 | 1    | 12   | 1.969,00 TL |
| BC3-4303-2413 | 3/63A. Makine Priz                       | IP44 | 1    | 24   | 1.425,00 TL |
| BC3-4303-2114 | 3/63A. Makine Fişi                       | IP44 | 1    | 24   | 1.425,00 TL |
| BC3-4303-2420 | 3/63A. 45° Eğik Makine Priz              | IP44 | 1    | 24   | 1.425,00 TL |
| BC3-4303-2510 | 3/63A. Duvar Priz                        | IP44 | 1    | 8    | 1.769,00 TL |
| BC3-4303-2535 | 3/63A. 90° Eğik Duvar Priz               | IP44 | 1    | 7    | 2.141,00 TL |
| BC3-4303-2537 | 3/63A. 90° Eğik P. Prizli Duvar Priz     | IP44 | 1    | 7    | 2.394,00 TL |
| BC3-4303-2210 | 3/63A. Duvar Fiş                         | IP44 | 1    | 8    | 1.686,00 TL |
| BC3-4303-2236 | 3/63A. 90° Eğik Duvar Fiş                | IP44 | 1    | 7    | 1.954,00 TL |
| BC3-4303-2238 | 3/63A. 90° Eğik P. Prizli Duvar Fiş      | IP44 | 1    | 7    | 2.223,00 TL |
| BC3-4303-2240 | 3/63A. 90° Eğik Pako Şalterli Duvar Fiş  | IP44 | 1    | 7    | 3.473,00 TL |
| BC3-4303-2550 | 3/63A. 90° Eğik Pako Şalterli Duvar Priz | IP44 | 1    | 7    | 3.587,00 TL |



BC3-4303-2011



BC3-4303-2312



BC3-4303-2413



BC3-4303-2114



BC3-4303-2420



BC3-4303-2535



BC3-4303-2537



BC3-4303-2238

| Ürün Kodu     | Açıklama                                      | IP   | Kutu | Koli | Fiyat       |
|---------------|---|------|------|------|-------------|
| BC3-4303-7011 | 3/63A. Düz Fiş                                | IP67 | 1    | 12   | 1.462,00 TL |
| BC3-4303-7312 | 3/63A. Uzatma Priz                            | IP67 | 1    | 12   | 2.088,00 TL |
| BC3-4303-7413 | 3/63A. Makine Priz                            | IP67 | 1    | 24   | 1.596,00 TL |
| BC3-4303-7114 | 3/63A. Makine Fişi                            | IP67 | 1    | 24   | 1.596,00 TL |
| BC3-4303-7420 | 3/63A. 45° Eğik Makine Priz                   | IP67 | 1    | 24   | 1.596,00 TL |
| BC3-4303-7510 | 3/63A. Duvar Priz                             | IP67 | 1    | 8    | 1.933,00 TL |
| BC3-4303-7535 | 3/63A. 90° Eğik Duvar Priz                    | IP67 | 1    | 7    | 2.223,00 TL |
| BC3-4303-7537 | 3/63A. 90° Eğik 1/16A. Mak. Prizli Duvar Priz | IP67 | 1    | 7    | 2.491,00 TL |
| BC3-4303-7210 | 3/63A. Duvar Fiş                              | IP67 | 1    | 8    | 1.865,00 TL |
| BC3-4303-7236 | 3/63A. 90° Eğik Duvar Fiş                     | IP67 | 1    | 7    | 2.208,00 TL |
| BC3-4303-7238 | 3/63A. 90° Eğik 1/16A. Mak. Prizli Duvar Fiş  | IP67 | 1    | 7    | 2.432,00 TL |
| BC3-4303-7240 | 3/63A. 90° Eğik Pako Şalterli Duvar Fiş       | IP65 | 1    | 7    | 3.721,00 TL |
| BC3-4303-7550 | 3/63A. 90° Eğik Pako Şalterli Duvar Priz      | IP65 | 1    | 7    | 3.836,00 TL |



BC3-4303-2240



BC3-4303-7011



BC3-4303-7312



BC3-4303-7114



BC3-4303-7413



BC3-4303-7420



BC3-4303-2550



BC3-4303-7236



BC3-4303-7535



BC3-4303-7537



BC3-4303-7550



BC3-4303-7240



| Ürün Kodu     | Açıklama                                 | IP   | Kutu | Koli | Fiyat       |
|---------------|--|------|------|------|-------------|
| BC1-4403-2011 | 3/63A. Düz Fiş                           | IP44 | 1    | 12   | 1.224,00 TL |
| BC1-4403-2312 | 3/63A. Uzatma Priz                       | IP44 | 1    | 12   | 1.813,00 TL |
| BC1-4403-2413 | 3/63A. Makine Priz                       | IP44 | 1    | 24   | 1.246,00 TL |
| BC1-4403-2114 | 3/63A. Makine Fişi                       | IP44 | 1    | 24   | 1.246,00 TL |
| BC1-4403-2420 | 3/63A. 45° Eğik Makine Priz              | IP44 | 1    | 24   | 1.246,00 TL |
| BC1-4403-2510 | 3/63A. Duvar Priz                        | IP44 | 1    | 8    | 1.629,00 TL |
| BC1-4403-2535 | 3/63A. 90° Eğik Duvar Priz               | IP44 | 1    | 7    | 1.984,00 TL |
| BC1-4403-2537 | 3/63A. 90° Eğik P. Prizli Duvar Priz     | IP44 | 1    | 7    | 2.237,00 TL |
| BC1-4403-2210 | 3/63A. Duvar Fiş                         | IP44 | 1    | 8    | 1.522,00 TL |
| BC1-4403-2236 | 3/63A. 90° Eğik Duvar Fiş                | IP44 | 1    | 7    | 1.805,00 TL |
| BC1-4403-2238 | 3/63A. 90° Eğik P. Prizli Duvar Fiş      | IP44 | 1    | 7    | 2.052,00 TL |
| BC1-4403-2240 | 3/63A. 90° Eğik Pako Şalterli Duvar Fiş  | IP44 | 1    | 7    | 3.414,00 TL |
| BC1-4403-2550 | 3/63A. 90° Eğik Pako Şalterli Duvar Priz | IP44 | 1    | 7    | 3.509,00 TL |

| Ürün Kodu     | Açıklama                                      | IP   | Kutu | Koli | Fiyat       |
|---------------|---|------|------|------|-------------|
| BC1-4403-7011 | 3/63A. Düz Fiş                                | IP67 | 1    | 12   | 1.306,00 TL |
| BC1-4403-7312 | 3/63A. Uzatma Priz                            | IP67 | 1    | 12   | 1.835,00 TL |
| BC1-4403-7413 | 3/63A. Makine Priz                            | IP67 | 1    | 24   | 1.447,00 TL |
| BC1-4403-7114 | 3/63A. Makine Fişi                            | IP67 | 1    | 24   | 1.447,00 TL |
| BC1-4403-7420 | 3/63A. 45° Eğik Makine Priz                   | IP67 | 1    | 24   | 1.447,00 TL |
| BC1-4403-7510 | 3/63A. Duvar Priz                             | IP67 | 1    | 8    | 1.769,00 TL |
| BC1-4403-7535 | 3/63A. 90° Eğik Duvar Priz                    | IP67 | 1    | 7    | 2.096,00 TL |
| BC1-4403-7537 | 3/63A. 90° Eğik 1/16A. Mak. Prizli Duvar Priz | IP67 | 1    | 7    | 2.357,00 TL |
| BC1-4403-7210 | 3/63A. Duvar Fiş                              | IP67 | 1    | 8    | 1.716,00 TL |
| BC1-4403-7236 | 3/63A. 90° Eğik Duvar Fiş                     | IP67 | 1    | 7    | 2.043,00 TL |
| BC1-4403-7238 | 3/63A. 90° Eğik 1/16A. Mak. Prizli Duvar Fiş  | IP67 | 1    | 7    | 2.283,00 TL |
| BC1-4403-7240 | 3/63A. 90° Eğik Pako Şalterli Duvar Fiş       | IP65 | 1    | 7    | 3.663,00 TL |
| BC1-4403-7550 | 3/63A. 90° Eğik Pako Şalterli Duvar Priz      | IP65 | 1    | 7    | 3.759,00 TL |



### 3 Kontaklı CEE Norm Seri



**3/63A. (2P+E) PİLOTLU**  
220V. 50/60 Hz. 6h  
(Polyamid 6)



| Ürün Kodu     | Açıklama                                 | IP   | Kutu | Koli | Fiyat       |
|---------------|--|------|------|------|-------------|
| BC3-4403-2011 | 3/63A. Düz Fiş                           | IP44 | 1    | 12   | 1.298,00 TL |
| BC3-4403-2312 | 3/63A. Uzatma Priz                       | IP44 | 1    | 12   | 1.888,00 TL |
| BC3-4403-2413 | 3/63A. Makine Priz                       | IP44 | 1    | 24   | 1.321,00 TL |
| BC3-4403-2114 | 3/63A. Makine Fişi                       | IP44 | 1    | 24   | 1.321,00 TL |
| BC3-4403-2420 | 3/63A. 45° Eğik Makine Priz              | IP44 | 1    | 24   | 1.321,00 TL |
| BC3-4403-2510 | 3/63A. Duvar Priz                        | IP44 | 1    | 8    | 1.686,00 TL |
| BC3-4403-2535 | 3/63A. 90° Eğik Duvar Priz               | IP44 | 1    | 7    | 2.058,00 TL |
| BC3-4403-2537 | 3/63A. 90° Eğik P. Prizli Duvar Priz     | IP44 | 1    | 7    | 2.313,00 TL |
| BC3-4403-2210 | 3/63A. Duvar Fiş                         | IP44 | 1    | 8    | 1.596,00 TL |
| BC3-4403-2236 | 3/63A. 90° Eğik Duvar Fiş                | IP44 | 1    | 7    | 1.879,00 TL |
| BC3-4403-2238 | 3/63A. 90° Eğik P. Prizli Duvar Fiş      | IP44 | 1    | 7    | 2.126,00 TL |
| BC3-4403-2240 | 3/63A. 90° Eğik Pako Şalterli Duvar Fiş  | IP44 | 1    | 7    | 3.473,00 TL |
| BC3-4403-2550 | 3/63A. 90° Eğik Pako Şalterli Duvar Priz | IP44 | 1    | 7    | 3.587,00 TL |

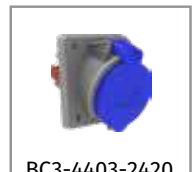

| Ürün Kodu     | Açıklama                                      | IP   | Kutu | Koli | Fiyat       |
|---------------|---|------|------|------|-------------|
| BC3-4403-7011 | 3/63A. Düz Fiş                                | IP67 | 1    | 12   | 1.380,00 TL |
| BC3-4403-7312 | 3/63A. Uzatma Priz                            | IP67 | 1    | 12   | 1.909,00 TL |
| BC3-4403-7413 | 3/63A. Makine Priz                            | IP67 | 1    | 24   | 1.522,00 TL |
| BC3-4403-7114 | 3/63A. Makine Fişi                            | IP67 | 1    | 24   | 1.522,00 TL |
| BC3-4403-7420 | 3/63A. 45° Eğik Makine Priz                   | IP67 | 1    | 24   | 1.522,00 TL |
| BC3-4403-7510 | 3/63A. Duvar Priz                             | IP67 | 1    | 8    | 1.843,00 TL |
| BC3-4403-7535 | 3/63A. 90° Eğik Duvar Priz                    | IP67 | 1    | 7    | 2.171,00 TL |
| BC3-4403-7537 | 3/63A. 90° Eğik 1/16A. Mak. Prizli Duvar Priz | IP67 | 1    | 7    | 2.432,00 TL |
| BC3-4403-7210 | 3/63A. Duvar Fiş                              | IP67 | 1    | 8    | 1.790,00 TL |
| BC3-4403-7236 | 3/63A. 90° Eğik Duvar Fiş                     | IP67 | 1    | 7    | 2.118,00 TL |
| BC3-4403-7238 | 3/63A. 90° Eğik 1/16A. Mak. Prizli Duvar Fiş  | IP67 | 1    | 7    | 2.357,00 TL |
| BC3-4403-7240 | 3/63A. 90° Eğik Pako Şalterli Duvar Fiş       | IP65 | 1    | 7    | 3.721,00 TL |
| BC3-4403-7550 | 3/63A. 90° Eğik Pako Şalterli Duvar Priz      | IP65 | 1    | 7    | 3.836,00 TL |



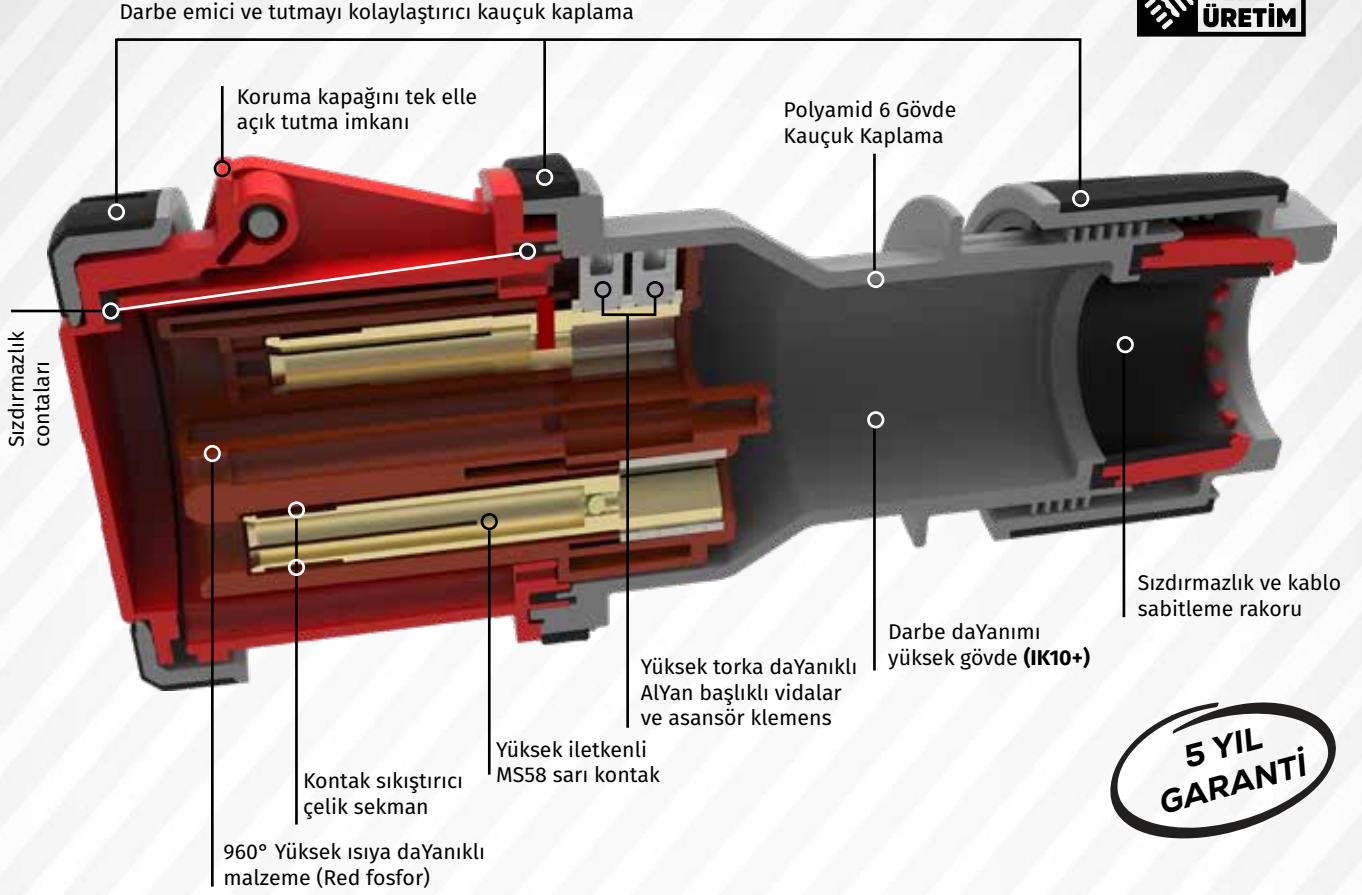

## Pilot kontak kullanımı:

**63/125A.** 3/4/5 Kontaktlı ürünlerde Pilot Kontaktlı / Pilot Kontaklı 2 seri bulunmaktadır.

Pilot Kontakt diğer kontaktlardan kısa ve incedir. Ayrı bir kablo çekilerek devre kesiciye bağlanarak kumanda devresi için kullanılır.

**NOT:** Kumanda devresi gerekmeyen kullanımlarda pilot kontaklı ürünlerimizin tercih edilmesi tavsiye olunur.

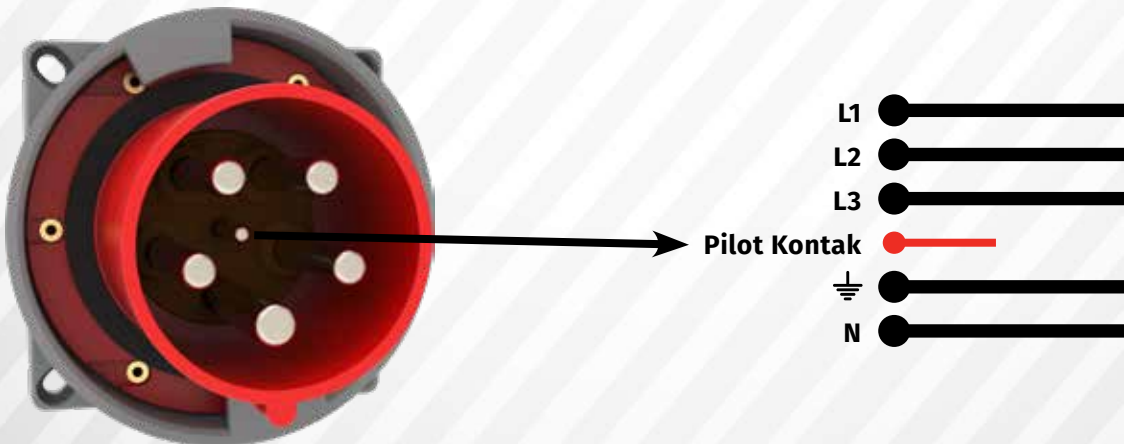

**RS**  
SERİSİ

**4/63A. (3P+E)**  
380V. 50/60 Hz. 6h  
(Polyamid 6)



| Ürün Kodu     | Açıklama                             | IP   | Kutu | Koli | Fiyat       |
|---------------|--------------------------------------|------|------|------|-------------|
| BC1-4504-2011 | 4/63A. Düz Fiş                       | IP44 | 1    | 12   | 1.240,00 TL |
| BC1-4504-2312 | 4/63A. Uzatma Priz                   | IP44 | 1    | 12   | 1.843,00 TL |
| BC1-4504-2413 | 4/63A. Makine Priz                   | IP44 | 1    | 24   | 1.254,00 TL |
| BC1-4504-2114 | 4/63A. Makine Fişi                   | IP44 | 1    | 24   | 1.254,00 TL |
| BC1-4504-2420 | 4/63A. 45° Eğik Makine Priz          | IP44 | 1    | 24   | 1.254,00 TL |
| BC1-4504-2510 | 4/63A. Duvar Priz                    | IP44 | 1    | 8    | 1.660,00 TL |
| BC1-4504-2535 | 4/63A. 90° Eğik Duvar Priz           | IP44 | 1    | 7    | 1.999,00 TL |
| BC1-4504-2537 | 4/63A. 90° Eğik P. Prizli Duvar Priz | IP44 | 1    | 7    | 2.148,00 TL |
| BC1-4504-2210 | 4/63A. Duvar Fiş                     | IP44 | 1    | 8    | 1.596,00 TL |
| BC1-4504-2236 | 4/63A. 90° Eğik Duvar Fiş            | IP44 | 1    | 7    | 1.924,00 TL |
| BC1-4504-2238 | 4/63A. 90° Eğik P. Prizli Duvar Fiş  | IP44 | 1    | 7    | 2.074,00 TL |

| Ürün Kodu     | Açıklama                                    | IP   | Kutu | Koli | Fiyat       |
|---------------|---|------|------|------|-------------|
| BC1-4504-7011 | 4/63A. Düz Fiş                              | IP67 | 1    | 12   | 1.315,00 TL |
| BC1-4504-7312 | 4/63A. Uzatma Priz                          | IP67 | 1    | 12   | 1.903,00 TL |
| BC1-4504-7413 | 4/63A. Makine Priz                          | IP67 | 1    | 24   | 1.477,00 TL |
| BC1-4504-7114 | 4/63A. Makine Fişi                          | IP67 | 1    | 24   | 1.477,00 TL |
| BC1-4504-7420 | 4/63A. 45° Eğik Makine Priz                 | IP67 | 1    | 24   | 1.477,00 TL |
| BC1-4504-7510 | 4/63A. Duvar Priz                           | IP67 | 1    | 8    | 1.865,00 TL |
| BC1-4504-7535 | 4/63A. 90° Eğik Duvar Priz                  | IP67 | 1    | 7    | 2.201,00 TL |
| BC1-4504-7537 | 4/63A. 90° Eğik 1/16A. M. Prizli Duvar Priz | IP67 | 1    | 7    | 2.462,00 TL |
| BC1-4504-7210 | 4/63A. Duvar Fiş                            | IP67 | 1    | 8    | 1.805,00 TL |
| BC1-4504-7236 | 4/63A. 90° Eğik Duvar Fiş                   | IP67 | 1    | 7    | 2.111,00 TL |
| BC1-4504-7238 | 4/63A. 90° Eğik 1/16A. M. Prizli Duvar Fiş  | IP67 | 1    | 7    | 2.387,00 TL |



### 4/63A. (3P+E) PİLOTLU

380V. 50/60 Hz. 6h  
(Polyamid 6)



| Ürün Kodu     | Açıklama                             | IP   | Kutu | Koli | Fiyat       |
|---------------|--------------------------------------|------|------|------|-------------|
| BC3-4504-2011 | 4/63A. Düz Fiş                       | IP44 | 1    | 12   | 1.298,00 TL |
| BC3-4504-2312 | 4/63A. Uzatma Priz                   | IP44 | 1    | 12   | 1.918,00 TL |
| BC3-4504-2413 | 4/63A. Makine Priz                   | IP44 | 1    | 24   | 1.328,00 TL |
| BC3-4504-2114 | 4/63A. Makine Fişi                   | IP44 | 1    | 24   | 1.328,00 TL |
| BC3-4504-2420 | 4/63A. 45° Eğik Makine Priz          | IP44 | 1    | 24   | 1.328,00 TL |
| BC3-4504-2510 | 4/63A. Duvar Priz                    | IP44 | 1    | 8    | 1.716,00 TL |
| BC3-4504-2535 | 4/63A. 90° Eğik Duvar Priz           | IP44 | 1    | 7    | 2.073,00 TL |
| BC3-4504-2537 | 4/63A. 90° Eğik P. Prizli Duvar Priz | IP44 | 1    | 7    | 2.223,00 TL |
| BC3-4504-2210 | 4/63A. Duvar Fiş                     | IP44 | 1    | 8    | 1.671,00 TL |
| BC3-4504-2236 | 4/63A. 90° Eğik Duvar Fiş            | IP44 | 1    | 7    | 1.999,00 TL |
| BC3-4504-2238 | 4/63A. 90° Eğik P. Prizli Duvar Fiş  | IP44 | 1    | 7    | 2.148,00 TL |



| Ürün Kodu     | Açıklama                                    | IP   | Kutu | Koli | Fiyat       |
|---------------|---|------|------|------|-------------|
| BC3-4504-7011 | 4/63A. Düz Fiş                              | IP67 | 1    | 12   | 1.373,00 TL |
| BC3-4504-7312 | 4/63A. Uzatma Priz                          | IP67 | 1    | 12   | 1.977,00 TL |
| BC3-4504-7413 | 4/63A. Makine Priz                          | IP67 | 1    | 24   | 1.552,00 TL |
| BC3-4504-7114 | 4/63A. Makine Fişi                          | IP67 | 1    | 24   | 1.552,00 TL |
| BC3-4504-7420 | 4/63A. 45° Eğik Makine Priz                 | IP67 | 1    | 24   | 1.552,00 TL |
| BC3-4504-7510 | 4/63A. Duvar Priz                           | IP67 | 1    | 8    | 1.939,00 TL |
| BC3-4504-7535 | 4/63A. 90° Eğik Duvar Priz                  | IP67 | 1    | 7    | 2.275,00 TL |
| BC3-4504-7537 | 4/63A. 90° Eğik 1/16A. M. Prizli Duvar Priz | IP67 | 1    | 7    | 2.536,00 TL |
| BC3-4504-7210 | 4/63A. Duvar Fiş                            | IP67 | 1    | 8    | 1.879,00 TL |
| BC3-4504-7236 | 4/63A. 90° Eğik Duvar Fiş                   | IP67 | 1    | 7    | 2.186,00 TL |
| BC3-4504-7238 | 4/63A. 90° Eğik 1/16A. M. Prizli Duvar Fiş  | IP67 | 1    | 7    | 2.462,00 TL |



## 5/63A. (3P+E+N)

380V. 50/60 Hz. 6h  
(Polyamid 6)



| Ürün Kodu     | Açıklama                             | IP   | Kutu | Koli | Fiyat       |
|---------------|--------------------------------------|------|------|------|-------------|
| BC1-4505-2011 | 5/63A. Düz Fiş                       | IP44 | 1    | 12   | 1.522,00 TL |
| BC1-4505-2312 | 5/63A. Uzatma Priz                   | IP44 | 1    | 12   | 2.089,00 TL |
| BC1-4505-2413 | 5/63A. Makine Priz                   | IP44 | 1    | 24   | 1.617,00 TL |
| BC1-4505-2114 | 5/63A. Makine Fişi                   | IP44 | 1    | 24   | 1.617,00 TL |
| BC1-4505-2420 | 5/63A. 45° Eğik Makine Priz          | IP44 | 1    | 24   | 1.617,00 TL |
| BC1-4505-2510 | 5/63A. Duvar Priz                    | IP44 | 1    | 8    | 1.992,00 TL |
| BC1-4505-2535 | 5/63A. 90° Eğik Duvar Priz           | IP44 | 1    | 7    | 2.357,00 TL |
| BC1-4505-2537 | 5/63A. 90° Eğik P. Prizli Duvar Priz | IP44 | 1    | 7    | 2.506,00 TL |
| BC1-4505-2210 | 5/63A. Duvar Fiş                     | IP44 | 1    | 8    | 1.939,00 TL |
| BC1-4505-2236 | 5/63A. 90° Eğik Duvar Fiş            | IP44 | 1    | 7    | 2.208,00 TL |
| BC1-4505-2238 | 5/63A. 90° Eğik P. Prizli Duvar Fiş  | IP44 | 1    | 7    | 2.357,00 TL |

| Ürün Kodu     | Açıklama                                    | IP   | Kutu | Koli | Fiyat       |
|---------------|---|------|------|------|-------------|
| BC1-4505-7011 | 5/63A. Düz Fiş                              | IP67 | 1    | 12   | 1.701,00 TL |
| BC1-4505-7312 | 5/63A. Uzatma Priz                          | IP67 | 1    | 12   | 2.231,00 TL |
| BC1-4505-7413 | 5/63A. Makine Priz                          | IP67 | 1    | 24   | 1.888,00 TL |
| BC1-4505-7114 | 5/63A. Makine Fişi                          | IP67 | 1    | 24   | 1.888,00 TL |
| BC1-4505-7420 | 5/63A. 45° Eğik Makine Priz                 | IP67 | 1    | 24   | 1.888,00 TL |
| BC1-4505-7510 | 5/63A. Duvar Priz                           | IP67 | 1    | 8    | 2.223,00 TL |
| BC1-4505-7535 | 5/63A. 90° Eğik Duvar Priz                  | IP67 | 1    | 7    | 2.566,00 TL |
| BC1-4505-7537 | 5/63A. 90° Eğik 1/16A. M. Prizli Duvar Priz | IP67 | 1    | 7    | 2.819,00 TL |
| BC1-4505-7210 | 5/63A. Duvar Fiş                            | IP67 | 1    | 8    | 2.178,00 TL |
| BC1-4505-7236 | 5/63A. 90° Eğik Duvar Fiş                   | IP67 | 1    | 7    | 2.462,00 TL |
| BC1-4505-7238 | 5/63A. 90° Eğik 1/16A. M. Prizli Duvar Fiş  | IP67 | 1    | 7    | 2.730,00 TL |



### 5/63A. (3P+E+N) PİLOTLU

380V. 50/60 Hz. 6h  
(Polyamid 6)



| Ürün Kodu     | Açıklama                             | IP   | Kutu | Koli | Fiyat       |
|---------------|--------------------------------------|------|------|------|-------------|
| BC3-4505-2011 | 5/63A. Düz Fiş                       | IP44 | 1    | 12   | 1.560,00 TL |
| BC3-4505-2312 | 5/63A. Uzatma Priz                   | IP44 | 1    | 12   | 2.144,00 TL |
| BC3-4505-2413 | 5/63A. Makine Priz                   | IP44 | 1    | 24   | 1.657,00 TL |
| BC3-4505-2114 | 5/63A. Makine Fişi                   | IP44 | 1    | 24   | 1.657,00 TL |
| BC3-4505-2420 | 5/63A. 45° Eğik Makine Priz          | IP44 | 1    | 24   | 1.657,00 TL |
| BC3-4505-2510 | 5/63A. Duvar Priz                    | IP44 | 1    | 8    | 2.067,00 TL |
| BC3-4505-2535 | 5/63A. 90° Eğik Duvar Priz           | IP44 | 1    | 7    | 2.432,00 TL |
| BC3-4505-2537 | 5/63A. 90° Eğik P. Prizli Duvar Priz | IP44 | 1    | 7    | 2.581,00 TL |
| BC3-4505-2210 | 5/63A. Duvar Fiş                     | IP44 | 1    | 8    | 2.014,00 TL |
| BC3-4505-2236 | 5/63A. 90° Eğik Duvar Fiş            | IP44 | 1    | 7    | 2.283,00 TL |
| BC3-4505-2238 | 5/63A. 90° Eğik P. Prizli Duvar Fiş  | IP44 | 1    | 7    | 2.432,00 TL |



| Ürün Kodu     | Açıklama                                    | IP   | Kutu | Koli | Fiyat       |
|---------------|---|------|------|------|-------------|
| BC3-4505-7011 | 5/63A. Düz Fiş                              | IP67 | 1    | 12   | 1.775,00 TL |
| BC3-4505-7312 | 5/63A. Uzatma Priz                          | IP67 | 1    | 12   | 2.305,00 TL |
| BC3-4505-7413 | 5/63A. Makine Priz                          | IP67 | 1    | 24   | 1.962,00 TL |
| BC3-4505-7114 | 5/63A. Makine Fişi                          | IP67 | 1    | 24   | 1.962,00 TL |
| BC3-4505-7420 | 5/63A. 45° Eğik Makine Priz                 | IP67 | 1    | 24   | 1.962,00 TL |
| BC3-4505-7510 | 5/63A. Duvar Priz                           | IP67 | 1    | 8    | 2.298,00 TL |
| BC3-4505-7535 | 5/63A. 90° Eğik Duvar Priz                  | IP67 | 1    | 7    | 2.640,00 TL |
| BC3-4505-7537 | 5/63A. 90° Eğik 1/16A. M. Prizli Duvar Priz | IP67 | 1    | 7    | 2.894,00 TL |
| BC3-4505-7210 | 5/63A. Duvar Fiş                            | IP67 | 1    | 8    | 2.253,00 TL |
| BC3-4505-7236 | 5/63A. 90° Eğik Duvar Fiş                   | IP67 | 1    | 7    | 2.536,00 TL |
| BC3-4505-7238 | 5/63A. 90° Eğik 1/16A. M. Prizli Duvar Fiş  | IP67 | 1    | 7    | 2.804,00 TL |

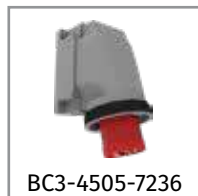
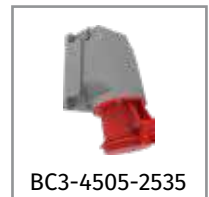



### 3/125A. (2P+E)

220V. 50/60 Hz. 6h  
(Polyamid 6)



| Ürün Kodu     | Açıklama  | IP   | Kutu | Koli | Fiyat       |
|---------------|---|------|------|------|-------------|
| BC1-6403-7011 | 3/125A. Düz Fiş                                 | IP67 | 1    | 8    | 4.072,00 TL |
| BC1-6403-7312 | 3/125A. Uzatma Priz                             | IP67 | 1    | 8    | 4.116,00 TL |
| BC1-6403-7413 | 3/125A. Makine Priz                             | IP67 | 1    | 8    | 3.908,00 TL |
| BC1-6403-7114 | 3/125A. Makine Fişi                             | IP67 | 1    | 8    | 3.908,00 TL |
| BC1-6403-7420 | 3/125A. 45° Eğik Makine Priz                    | IP67 | 1    | 8    | 3.908,00 TL |
| BC1-6403-7236 | 3/125A. 90° Eğik Duvar Fişi                     | IP67 | 1    | 4    | 4.937,00 TL |
| BC1-6403-7535 | 3/125A. 90° Eğik Duvar Prizi                    | IP67 | 1    | 4    | 4.803,00 TL |
| BC1-6403-7238 | 3/125A. 90° Eğik 1/16A. Mak. Prizli Duvar Fişi  | IP67 | 1    | 4    | 5.430,00 TL |
| BC1-6403-7537 | 3/125A. 90° Eğik 1/16A. Mak. Prizli Duvar Prizi | IP67 | 1    | 4    | 5.296,00 TL |
| BC1-6403-7240 | 3/125A. 90° Eğik Pako Şalterli Duvar Fişi       | IP65 | 1    | 4    | 6.066,00 TL |
| BC1-6403-7550 | 3/125A. 90° Eğik Pako Şalterli Duvar Prizi      | IP65 | 1    | 4    | 6.026,00 TL |



### 3/125A. (2P+E) PİLOTLU

220V. 50/60 Hz. 6h  
(Polyamid 6)



| Ürün Kodu     | Açıklama  | IP   | Kutu | Koli | Fiyat       |
|---------------|---|------|------|------|-------------|
| BC3-6403-7011 | 3/125A. Düz Fiş                                 | IP67 | 1    | 8    | 4.176,00 TL |
| BC3-6403-7312 | 3/125A. Uzatma Priz                             | IP67 | 1    | 8    | 4.221,00 TL |
| BC3-6403-7413 | 3/125A. Makine Priz                             | IP67 | 1    | 8    | 4.012,00 TL |
| BC3-6403-7114 | 3/125A. Makine Fişi                             | IP67 | 1    | 8    | 4.012,00 TL |
| BC3-6403-7420 | 3/125A. 45° Eğik Makine Priz                    | IP67 | 1    | 8    | 4.012,00 TL |
| BC3-6403-7236 | 3/125A. 90° Eğik Duvar Fişi                     | IP67 | 1    | 4    | 5.041,00 TL |
| BC3-6403-7535 | 3/125A. 90° Eğik Duvar Prizi                    | IP67 | 1    | 4    | 4.907,00 TL |
| BC3-6403-7238 | 3/125A. 90° Eğik 1/16A. Mak. Prizli Duvar Fişi  | IP67 | 1    | 4    | 5.534,00 TL |
| BC3-6403-7537 | 3/125A. 90° Eğik 1/16A. Mak. Prizli Duvar Prizi | IP67 | 1    | 4    | 5.400,00 TL |
| BC3-6403-7240 | 3/125A. 90° Eğik Pako Şalterli Duvar Fişi       | IP65 | 1    | 4    | 6.139,00 TL |
| BC3-6403-7550 | 3/125A. 90° Eğik Pako Şalterli Duvar Prizi      | IP65 | 1    | 4    | 6.119,00 TL |



### 4/125A. (3P+E)

380V. 50/60 Hz. 6h  
(Polyamid 6)



| Ürün Kodu     | Açıklama  | IP   | Kutu | Koli | Fiyat        |
|---------------|---|------|------|------|--------------|
| BC1-6504-7011 | 4/125A. Düz Fiş                                 | IP67 | 1    | 8    | 4.206,00 TL  |
| BC1-6504-7312 | 4/125A. Uzatma Priz                             | IP67 | 1    | 8    | 4.295,00 TL  |
| BC1-6504-7413 | 4/125A. Makine Priz                             | IP67 | 1    | 8    | 4.152,00 TL  |
| BC1-6504-7114 | 4/125A. Makine Fişi                             | IP67 | 1    | 8    | 4.152,00 TL  |
| BC1-6504-7420 | 4/125A. 45° Eğik Makine Priz                    | IP67 | 1    | 8    | 4.152,00 TL  |
| BC1-6504-7236 | 4/125A. 90° Eğik Duvar Fişi                     | IP67 | 1    | 4    | 5.265,00 TL  |
| BC1-6504-7535 | 4/125A. 90° Eğik Duvar Prizi                    | IP67 | 1    | 4    | 5.309,00 TL  |
| BC1-6504-7238 | 4/125A. 90° Eğik 1/16A. Mak. Prizli Duvar Fişi  | IP67 | 1    | 4    | 5.759,00 TL  |
| BC1-6504-7537 | 4/125A. 90° Eğik 1/16A. Mak. Prizli Duvar Prizi | IP67 | 1    | 4    | 5.803,00 TL  |
| BC1-6504-7240 | 4/125A. 90° Eğik Pako Şalterli Duvar Fişi       | IP65 | 1    | 4    | 10.983,00 TL |
| BC1-6504-7550 | 4/125A. 90° Eğik Pako Şalterli Duvar Prizi      | IP65 | 1    | 4    | 11.363,00 TL |



### 4/125A. (3P+E) PİLOTLU

380V. 50/60 Hz. 6h  
(Polyamid 6)



| Ürün Kodu     | Açıklama  | IP   | Kutu | Koli | Fiyat        |
|---------------|---|------|------|------|--------------|
| BC3-6504-7011 | 4/125A. Düz Fiş                                 | IP67 | 1    | 8    | 4.288,00 TL  |
| BC3-6504-7312 | 4/125A. Uzatma Priz                             | IP67 | 1    | 8    | 4.394,00 TL  |
| BC3-6504-7413 | 4/125A. Makine Priz                             | IP67 | 1    | 8    | 4.255,00 TL  |
| BC3-6504-7114 | 4/125A. Makine Fişi                             | IP67 | 1    | 8    | 4.255,00 TL  |
| BC3-6504-7420 | 4/125A. 45° Eğik Makine Priz                    | IP67 | 1    | 8    | 4.255,00 TL  |
| BC3-6504-7236 | 4/125A. 90° Eğik Duvar Fişi                     | IP67 | 1    | 4    | 5.369,00 TL  |
| BC3-6504-7535 | 4/125A. 90° Eğik Duvar Prizi                    | IP67 | 1    | 4    | 5.414,00 TL  |
| BC3-6504-7238 | 4/125A. 90° Eğik 1/16A. Mak. Prizli Duvar Fişi  | IP67 | 1    | 4    | 5.863,00 TL  |
| BC3-6504-7537 | 4/125A. 90° Eğik 1/16A. Mak. Prizli Duvar Prizi | IP67 | 1    | 4    | 5.908,00 TL  |
| BC3-6504-7240 | 4/125A. 90° Eğik Pako Şalterli Duvar Fişi       | IP65 | 1    | 4    | 11.056,00 TL |
| BC3-6504-7550 | 4/125A. 90° Eğik Pako Şalterli Duvar Prizi      | IP65 | 1    | 4    | 11.455,00 TL |



## 5/125A. (3P+E+N)

380V. 50/60 Hz. 6h  
(Polyamid 6)



| Ürün Kodu     | Açıklama  | IP   | Kutu | Koli | Fiyat        |
|---------------|---|------|------|------|--------------|
| BC1-6505-7011 | 5/125A. Düz Fiş                                 | IP67 | 1    | 8    | 4.288,00 TL  |
| BC1-6505-7312 | 5/125A. Uzatma Priz                             | IP67 | 1    | 8    | 4.394,00 TL  |
| BC1-6505-7413 | 5/125A. Makine Priz                             | IP67 | 1    | 8    | 4.255,00 TL  |
| BC1-6505-7114 | 5/125A. Makine Fişi                             | IP67 | 1    | 8    | 4.255,00 TL  |
| BC1-6505-7420 | 5/125A. 45° Eğik Makine Priz                    | IP67 | 1    | 8    | 4.255,00 TL  |
| BC1-6505-7236 | 5/125A. 90° Eğik Duvar Fişi                     | IP67 | 1    | 4    | 5.564,00 TL  |
| BC1-6505-7535 | 5/125A. 90° Eğik Duvar Prizi                    | IP67 | 1    | 4    | 5.623,00 TL  |
| BC1-6505-7238 | 5/125A. 90° Eğik 1/16A. Mak. Prizli Duvar Fişi  | IP67 | 1    | 4    | 6.057,00 TL  |
| BC1-6505-7537 | 5/125A. 90° Eğik 1/16A. Mak. Prizli Duvar Prizi | IP67 | 1    | 4    | 6.116,00 TL  |
| BC1-6505-7240 | 5/125A. 90° Eğik Pako Şalterli Duvar Fişi       | IP65 | 1    | 4    | 11.506,00 TL |
| BC1-6505-7550 | 5/125A. 90° Eğik Pako Şalterli Duvar Prizi      | IP65 | 1    | 4    | 11.347,00 TL |



## 5/125A. (3P+E+N) PİLOTLU

380V. 50/60 Hz. 6h  
(Polyamid 6)



| Ürün Kodu     | Açıklama  | IP   | Kutu | Koli | Fiyat        |
|---------------|---|------|------|------|--------------|
| BC3-6505-7011 | 5/125A. Düz Fiş                                 | IP67 | 1    | 8    | 4.344,00 TL  |
| BC3-6505-7312 | 5/125A. Uzatma Priz                             | IP67 | 1    | 8    | 4.450,00 TL  |
| BC3-6505-7413 | 5/125A. Makine Priz                             | IP67 | 1    | 8    | 4.310,00 TL  |
| BC3-6505-7114 | 5/125A. Makine Fişi                             | IP67 | 1    | 8    | 4.310,00 TL  |
| BC3-6505-7420 | 5/125A. 45° Eğik Makine Priz                    | IP67 | 1    | 8    | 4.310,00 TL  |
| BC3-6505-7236 | 5/125A. 90° Eğik Duvar Fişi                     | IP67 | 1    | 4    | 5.668,00 TL  |
| BC3-6505-7535 | 5/125A. 90° Eğik Duvar Prizi                    | IP67 | 1    | 4    | 5.728,00 TL  |
| BC3-6505-7238 | 5/125A. 90° Eğik 1/16A. Mak. Prizli Duvar Fişi  | IP67 | 1    | 4    | 6.161,00 TL  |
| BC3-6505-7537 | 5/125A. 90° Eğik 1/16A. Mak. Prizli Duvar Prizi | IP67 | 1    | 4    | 6.221,00 TL  |
| BC3-6505-7240 | 5/125A. 90° Eğik Pako Şalterli Duvar Fişi       | IP65 | 1    | 4    | 11.579,00 TL |
| BC3-6505-7550 | 5/125A. 90° Eğik Pako Şalterli Duvar Prizi      | IP65 | 1    | 4    | 11.440,00 TL |



# **TÜRKİYE’de İLK**

## **CEE Norm 160A. 380V.**



Özel Gümüş Kaplamalı Kontaklar

### 4/160A. (3P+E) 380V. 50/60 Hz. 7h (Polyamid 6)



| Ürün Kodu     | Açıklama  | IP   | Kutu | Koli | Fiyat        |
|---------------|---|------|------|------|--------------|
| BC1-8504-7011 | 4/160A. Düz Fiş                                 | IP67 | 1    | 8    | 6.528,00 TL  |
| BC1-8504-7312 | 4/160A. Uzatma Priz                             | IP67 | 1    | 8    | 6.683,00 TL  |
| BC1-8504-7413 | 4/160A. Makine Priz                             | IP67 | 1    | 8    | 6.528,00 TL  |
| BC1-8504-7114 | 4/160A. Makine Fişi                             | IP67 | 1    | 8    | 6.528,00 TL  |
| BC1-8504-7420 | 4/160A. 45° Eğik Makine Priz                    | IP67 | 1    | 8    | 6.528,00 TL  |
| BC1-8504-7236 | 4/160A. 90° Eğik Duvar Fişi                     | IP67 | 1    | 4    | 8.230,00 TL  |
| BC1-8504-7535 | 4/160A. 90° Eğik Duvar Prizi                    | IP67 | 1    | 4    | 8.230,00 TL  |
| BC1-8504-7238 | 4/160A. 90° Eğik 1/16A. Mak. Prizli Duvar Fişi  | IP67 | 1    | 4    | 9.003,00 TL  |
| BC1-8504-7537 | 4/160A. 90° Eğik 1/16A. Mak. Prizli Duvar Prizi | IP67 | 1    | 4    | 9.003,00 TL  |
| BC1-8504-7240 | 4/160A. 90° Eğik Pako Şalterli Duvar Fişi       | IP65 | 1    | 4    | 12.235,00 TL |
| BC1-8504-7550 | 4/160A. 90° Eğik Pako Şalterli Duvar Prizi      | IP65 | 1    | 4    | 12.574,00 TL |



### 5/160A. (3P+E+N) 380V. 50/60 Hz. 7h (Polyamid 6)



## 5 Kontaklı CEE Norm Seri



| Ürün Kodu     | Açıklama  | IP   | Kutu | Koli | Fiyat        |
|---------------|---|------|------|------|--------------|
| BC1-8505-7011 | 5/160A. Düz Fiş                                 | IP67 | 1    | 8    | 6.683,00 TL  |
| BC1-8505-7312 | 5/160A. Uzatma Priz                             | IP67 | 1    | 8    | 6.838,00 TL  |
| BC1-8505-7413 | 5/160A. Makine Priz                             | IP67 | 1    | 8    | 6.683,00 TL  |
| BC1-8505-7114 | 5/160A. Makine Fişi                             | IP67 | 1    | 8    | 6.683,00 TL  |
| BC1-8505-7420 | 5/160A. 45° Eğik Makine Priz                    | IP67 | 1    | 8    | 6.683,00 TL  |
| BC1-8505-7236 | 5/160A. 90° Eğik Duvar Fişi                     | IP67 | 1    | 4    | 8.385,00 TL  |
| BC1-8505-7535 | 5/160A. 90° Eğik Duvar Prizi                    | IP67 | 1    | 4    | 8.385,00 TL  |
| BC1-8505-7238 | 5/160A. 90° Eğik 1/16A. Mak. Prizli Duvar Fişi  | IP67 | 1    | 4    | 9.158,00 TL  |
| BC1-8505-7537 | 5/160A. 90° Eğik 1/16A. Mak. Prizli Duvar Prizi | IP67 | 1    | 4    | 9.158,00 TL  |
| BC1-8505-7240 | 5/160A. 90° Eğik Pako Şalterli Duvar Fişi       | IP65 | 1    | 4    | 12.909,00 TL |
| BC1-8505-7550 | 5/160A. 90° Eğik Pako Şalterli Duvar Prizi      | IP65 | 1    | 4    | 13.294,00 TL |





## 3/16A. (2P+E) 220V. 50/60 Hz. 6h (Polyamid 6)

IP44



BCS-1403-2011

BCS-1403-2312



BCS-1403-2413



BCS-1403-2114

BCS-1403-2420

IP67



BCS-1403-7011

BCS-1403-7312



BCS-1403-7413



BCS-1403-7114

BCS-1403-7420

| Ürün Kodu     | Açıklama                    | IP   | Kutu | Koli | Fiyat     |
|---------------|-----------------------------|------|------|------|-----------|
| BCS-1403-2011 | 3/16A. Düz Fiş              | IP44 | 10   | 120  | 223,00 TL |
| BCS-1403-2312 | 3/16A. Uzatma Priz          | IP44 | 10   | 120  | 293,00 TL |
| BCS-1403-2413 | 3/16A. Makine Priz          | IP44 | 15   | 120  | 273,00 TL |
| BCS-1403-2114 | 3/16A. Makine Fişi          | IP44 | 10   | 120  | 273,00 TL |
| BCS-1403-2420 | 3/16A. 45° Eğik Makine Priz | IP44 | 8    | 96   | 273,00 TL |

| Ürün Kodu     | Açıklama                    | IP   | Kutu | Koli | Fiyat     |
|---------------|-----------------------------|------|------|------|-----------|
| BCS-1403-7011 | 3/16A. Düz Fiş              | IP67 | 8    | 96   | 360,00 TL |
| BCS-1403-7312 | 3/16A. Uzatma Priz          | IP67 | 8    | 96   | 471,00 TL |
| BCS-1403-7413 | 3/16A. Makine Priz          | IP67 | 8    | 96   | 446,00 TL |
| BCS-1403-7114 | 3/16A. Makine Fişi          | IP67 | 10   | 120  | 446,00 TL |
| BCS-1403-7420 | 3/16A. 45° Eğik Makine Priz | IP67 | 6    | 72   | 446,00 TL |



## 4/16A. (3P+E) 380V. 50/60 Hz. 6h (Polyamid 6)

IP44



BCS-1504-2011

BCS-1504-2312



BCS-1504-2413



BCS-1504-2114

BCS-1504-2420

IP67



BCS-1504-7011

BCS-1504-7312



BCS-1504-7413



BCS-1504-7114

BCS-1504-7420

| Ürün Kodu     | Açıklama                    | IP   | Kutu | Koli | Fiyat     |
|---------------|-----------------------------|------|------|------|-----------|
| BCS-1504-2011 | 4/16A. Düz Fiş              | IP44 | 8    | 96   | 262,00 TL |
| BCS-1504-2312 | 4/16A. Uzatma Priz          | IP44 | 8    | 96   | 354,00 TL |
| BCS-1504-2413 | 4/16A. Makine Priz          | IP44 | 15   | 120  | 323,00 TL |
| BCS-1504-2114 | 4/16A. Makine Fişi          | IP44 | 10   | 120  | 323,00 TL |
| BCS-1504-2420 | 4/16A. 45° Eğik Makine Priz | IP44 | 8    | 96   | 323,00 TL |

| Ürün Kodu     | Açıklama                    | IP   | Kutu | Koli | Fiyat     |
|---------------|-----------------------------|------|------|------|-----------|
| BCS-1504-7011 | 4/16A. Düz Fiş              | IP67 | 6    | 72   | 399,00 TL |
| BCS-1504-7312 | 4/16A. Uzatma Priz          | IP67 | 6    | 72   | 552,00 TL |
| BCS-1504-7413 | 4/16A. Makine Priz          | IP67 | 6    | 72   | 532,00 TL |
| BCS-1504-7114 | 4/16A. Makine Fişi          | IP67 | 10   | 120  | 532,00 TL |
| BCS-1504-7420 | 4/16A. 45° Eğik Makine Priz | IP67 | 6    | 72   | 532,00 TL |



## 5/16A. (3P+E+N) 380V. 50/60 Hz. 6h (Polyamid 6)

IP44



BCS-1505-2011

BCS-1505-2312



BCS-1505-2413



BCS-1505-2114

BCS-1505-2420

IP67



BCS-1505-7011

BCS-1505-7312



BCS-1505-7413



BCS-1505-7114

BCS-1505-7420

| Ürün Kodu     | Açıklama                    | IP   | Kutu | Koli | Fiyat     |
|---------------|-----------------------------|------|------|------|-----------|
| BCS-1505-2011 | 5/16A. Düz Fiş              | IP44 | 8    | 96   | 321,00 TL |
| BCS-1505-2312 | 5/16A. Uzatma Priz          | IP44 | 8    | 96   | 427,00 TL |
| BCS-1505-2413 | 5/16A. Makine Priz          | IP44 | 15   | 120  | 404,00 TL |
| BCS-1505-2114 | 5/16A. Makine Fişi          | IP44 | 8    | 96   | 404,00 TL |
| BCS-1505-2420 | 5/16A. 45° Eğik Makine Priz | IP44 | 6    | 72   | 404,00 TL |

| Ürün Kodu     | Açıklama                    | IP   | Kutu | Koli | Fiyat     |
|---------------|-----------------------------|------|------|------|-----------|
| BCS-1505-7011 | 5/16A. Düz Fiş              | IP67 | 4    | 48   | 465,00 TL |
| BCS-1505-7312 | 5/16A. Uzatma Priz          | IP67 | 4    | 48   | 596,00 TL |
| BCS-1505-7413 | 5/16A. Makine Priz          | IP67 | 6    | 72   | 569,00 TL |
| BCS-1505-7114 | 5/16A. Makine Fişi          | IP67 | 6    | 72   | 569,00 TL |
| BCS-1505-7420 | 5/16A. 45° Eğik Makine Priz | IP67 | 6    | 72   | 569,00 TL |

# Işık ve Ses Sistemleri Siyah Seri CEE Norm



5 YIL  
GARANTİ



## 3/32A. (2P+E) 220V. 50/60 Hz. 6h (Polyamid 6)

| Ürün Kodu     | Açıklama                    | IP   | Kutu | Koli | Fiyat     |
|---------------|-----------------------------|------|------|------|-----------|
| BCS-3403-2011 | 3/32A. Düz Fiş              | IP44 | 8    | 64   | 357,00 TL |
| BCS-3403-2312 | 3/32A. Uzatma Priz          | IP44 | 8    | 64   | 438,00 TL |
| BCS-3403-2413 | 3/32A. Makine Priz          | IP44 | 8    | 64   | 401,00 TL |
| BCS-3403-2114 | 3/32A. Makine Fişi          | IP44 | 8    | 96   | 401,00 TL |
| BCS-3403-2420 | 3/32A. 45° Eğik Makine Priz | IP44 | 4    | 48   | 401,00 TL |

IP44



BCS-3403-2011

BCS-3403-2312



BCS-3403-2413

BCS-3403-2114

BCS-3403-2420

| Ürün Kodu     | Açıklama                    | IP   | Kutu | Koli | Fiyat     |
|---------------|-----------------------------|------|------|------|-----------|
| BCS-3403-7011 | 3/32A. Düz Fiş              | IP67 | 3    | 36   | 499,00 TL |
| BCS-3403-7312 | 3/32A. Uzatma Priz          | IP67 | 3    | 36   | 633,00 TL |
| BCS-3403-7413 | 3/32A. Makine Priz          | IP67 | 4    | 48   | 577,00 TL |
| BCS-3403-7114 | 3/32A. Makine Fişi          | IP67 | 6    | 72   | 577,00 TL |
| BCS-3403-7420 | 3/32A. 45° Eğik Makine Priz | IP67 | 4    | 48   | 577,00 TL |

IP67



BCS-3403-7011

BCS-3403-7312



BCS-3403-7413

BCS-3403-7114

BCS-3403-7420



## 4/32A. (3P+E) 380V. 50/60 Hz. 6h (Polyamid 6)

| Ürün Kodu     | Açıklama                    | IP   | Kutu | Koli | Fiyat     |
|---------------|-----------------------------|------|------|------|-----------|
| BCS-3504-2011 | 4/32A. Düz Fiş              | IP44 | 8    | 64   | 374,00 TL |
| BCS-3504-2312 | 4/32A. Uzatma Priz          | IP44 | 8    | 64   | 491,00 TL |
| BCS-3504-2413 | 4/32A. Makine Priz          | IP44 | 8    | 64   | 446,00 TL |
| BCS-3504-2114 | 4/32A. Makine Fişi          | IP44 | 8    | 96   | 446,00 TL |
| BCS-3504-2420 | 4/32A. 45° Eğik Makine Priz | IP44 | 4    | 48   | 446,00 TL |

IP44



BCS-3504-2011

BCS-3504-2312



BCS-3504-2413

BCS-3504-2114

BCS-3504-2420

| Ürün Kodu     | Açıklama                    | IP   | Kutu | Koli | Fiyat     |
|---------------|-----------------------------|------|------|------|-----------|
| BCS-3504-7011 | 4/32A. Düz Fiş              | IP67 | 3    | 36   | 552,00 TL |
| BCS-3504-7312 | 4/32A. Uzatma Priz          | IP67 | 3    | 36   | 672,00 TL |
| BCS-3504-7413 | 4/32A. Makine Priz          | IP67 | 4    | 48   | 621,00 TL |
| BCS-3504-7114 | 4/32A. Makine Fişi          | IP67 | 6    | 72   | 621,00 TL |
| BCS-3504-7420 | 4/32A. 45° Eğik Makine Priz | IP67 | 4    | 48   | 621,00 TL |

IP67



BCS-3504-7011

BCS-3504-7312



BCS-3504-7413

BCS-3504-7114

BCS-3504-7420



## 5/32A. (3P+E+N) 380V. 50/60 Hz. 6h (Polyamid 6)

| Ürün Kodu     | Açıklama                    | IP   | Kutu | Koli | Fiyat     |
|---------------|-----------------------------|------|------|------|-----------|
| BCS-3505-2011 | 5/32A. Düz Fiş              | IP44 | 8    | 64   | 415,00 TL |
| BCS-3505-2312 | 5/32A. Uzatma Priz          | IP44 | 8    | 64   | 527,00 TL |
| BCS-3505-2413 | 5/32A. Makine Priz          | IP44 | 8    | 64   | 504,00 TL |
| BCS-3505-2114 | 5/32A. Makine Fişi          | IP44 | 8    | 96   | 504,00 TL |
| BCS-3505-2420 | 5/32A. 45° Eğik Makine Priz | IP44 | 6    | 72   | 504,00 TL |

IP44



BCS-3505-2011

BCS-3505-2312



BCS-3505-2413

BCS-3505-2114

BCS-3505-2420

| Ürün Kodu     | Açıklama                    | IP   | Kutu | Koli | Fiyat     |
|---------------|-----------------------------|------|------|------|-----------|
| BCS-3505-7011 | 5/32A. Düz Fiş              | IP67 | 3    | 36   | 582,00 TL |
| BCS-3505-7312 | 5/32A. Uzatma Priz          | IP67 | 3    | 36   | 724,00 TL |
| BCS-3505-7413 | 5/32A. Makine Priz          | IP67 | 4    | 48   | 674,00 TL |
| BCS-3505-7114 | 5/32A. Makine Fişi          | IP67 | 6    | 72   | 674,00 TL |
| BCS-3505-7420 | 5/32A. 45° Eğik Makine Priz | IP67 | 4    | 48   | 674,00 TL |

IP67



BCS-3505-7011

BCS-3505-7312



BCS-3505-7413

BCS-3505-7114

BCS-3505-7420



## 3/63A. (2P+E) 220V. 50/60 Hz. 6h (Polyamid 6)



| Ürün Kodu     | Açıklama                    | IP   | Kutu | Koli | Fiyat       |
|---------------|-----------------------------|------|------|------|-------------|
| BCS-4403-2011 | 3/63A. Düz Fiş              | IP44 | 1    | 12   | 1.345,00 TL |
| BCS-4403-2312 | 3/63A. Uzatma Priz          | IP44 | 1    | 12   | 1.991,00 TL |
| BCS-4403-2413 | 3/63A. Makine Priz          | IP44 | 1    | 24   | 1.370,00 TL |
| BCS-4403-2114 | 3/63A. Makine Fişi          | IP44 | 1    | 24   | 1.370,00 TL |
| BCS-4403-2420 | 3/63A. 45° Eğik Makine Priz | IP44 | 1    | 24   | 1.370,00 TL |



| Ürün Kodu     | Açıklama                    | IP   | Kutu | Koli | Fiyat       |
|---------------|-----------------------------|------|------|------|-------------|
| BCS-4403-7011 | 3/63A. Düz Fiş              | IP67 | 1    | 12   | 1.434,00 TL |
| BCS-4403-7312 | 3/63A. Uzatma Priz          | IP67 | 1    | 12   | 2.016,00 TL |
| BCS-4403-7413 | 3/63A. Makine Priz          | IP67 | 1    | 24   | 1.590,00 TL |
| BCS-4403-7114 | 3/63A. Makine Fişi          | IP67 | 1    | 24   | 1.590,00 TL |
| BCS-4403-7420 | 3/63A. 45° Eğik Makine Priz | IP67 | 1    | 24   | 1.590,00 TL |



## 4/63A. (3P+E) 380V. 50/60 Hz. 6h (Polyamid 6)



| Ürün Kodu     | Açıklama                    | IP   | Kutu | Koli | Fiyat       |
|---------------|-----------------------------|------|------|------|-------------|
| BCS-4504-2011 | 4/63A. Düz Fiş              | IP44 | 1    | 12   | 1.365,00 TL |
| BCS-4504-2312 | 4/63A. Uzatma Priz          | IP44 | 1    | 12   | 2.025,00 TL |
| BCS-4504-2413 | 4/63A. Makine Priz          | IP44 | 1    | 24   | 1.379,00 TL |
| BCS-4504-2114 | 4/63A. Makine Fişi          | IP44 | 1    | 24   | 1.379,00 TL |
| BCS-4504-2420 | 4/63A. 45° Eğik Makine Priz | IP44 | 1    | 24   | 1.379,00 TL |



| Ürün Kodu     | Açıklama                    | IP   | Kutu | Koli | Fiyat       |
|---------------|-----------------------------|------|------|------|-------------|
| BCS-4504-7011 | 4/63A. Düz Fiş              | IP67 | 1    | 12   | 1.448,00 TL |
| BCS-4504-7312 | 4/63A. Uzatma Priz          | IP67 | 1    | 12   | 2.092,00 TL |
| BCS-4504-7413 | 4/63A. Makine Priz          | IP67 | 1    | 24   | 1.624,00 TL |
| BCS-4504-7114 | 4/63A. Makine Fişi          | IP67 | 1    | 24   | 1.624,00 TL |
| BCS-4504-7420 | 4/63A. 45° Eğik Makine Priz | IP67 | 1    | 24   | 1.624,00 TL |



## 5/63A. (3P+E+N) 380V. 50/60 Hz. 6h (Polyamid 6)



| Ürün Kodu     | Açıklama                    | IP   | Kutu | Koli | Fiyat       |
|---------------|-----------------------------|------|------|------|-------------|
| BCS-4505-2011 | 5/63A. Düz Fiş              | IP44 | 1    | 12   | 1.674,00 TL |
| BCS-4505-2312 | 5/63A. Uzatma Priz          | IP44 | 1    | 12   | 2.298,00 TL |
| BCS-4505-2413 | 5/63A. Makine Priz          | IP44 | 1    | 24   | 1.777,00 TL |
| BCS-4505-2114 | 5/63A. Makine Fişi          | IP44 | 1    | 24   | 1.777,00 TL |
| BCS-4505-2420 | 5/63A. 45° Eğik Makine Priz | IP44 | 1    | 24   | 1.777,00 TL |



| Ürün Kodu     | Açıklama                    | IP   | Kutu | Koli | Fiyat       |
|---------------|-----------------------------|------|------|------|-------------|
| BCS-4505-7011 | 5/63A. Düz Fiş              | IP67 | 1    | 12   | 1.869,00 TL |
| BCS-4505-7312 | 5/63A. Uzatma Priz          | IP67 | 1    | 12   | 2.454,00 TL |
| BCS-4505-7413 | 5/63A. Makine Priz          | IP67 | 1    | 24   | 2.075,00 TL |
| BCS-4505-7114 | 5/63A. Makine Fişi          | IP67 | 1    | 24   | 2.075,00 TL |
| BCS-4505-7420 | 5/63A. 45° Eğik Makine Priz | IP67 | 1    | 24   | 2.075,00 TL |



# Işık ve Ses Sistemleri Siyah Seri CEE Norm



## 3/125A. (2P+E) 220V. 50/60 Hz. 6h (Polyamid 6)

| Ürün Kodu     | Açıklama                     | IP   | Kutu | Koli | Fiyat       |
|---------------|------------------------------|------|------|------|-------------|
| BCS-6403-7011 | 3/125A. Düz Fiş              | IP67 | 1    | 8    | 4.478,00 TL |
| BCS-6403-7312 | 3/125A. Uzatma Priz          | IP67 | 1    | 8    | 4.525,00 TL |
| BCS-6403-7413 | 3/125A. Makine Priz          | IP67 | 1    | 8    | 4.297,00 TL |
| BCS-6403-7114 | 3/125A. Makine Fişi          | IP67 | 1    | 8    | 4.297,00 TL |
| BCS-6403-7420 | 3/125A. 45° Eğik Makine Priz | IP67 | 1    | 8    | 4.297,00 TL |



## 4/125A. (3P+E) 380V. 50/60 Hz. 6h (Polyamid 6)

| Ürün Kodu     | Açıklama                     | IP   | Kutu | Koli | Fiyat       |
|---------------|------------------------------|------|------|------|-------------|
| BCS-6504-7011 | 4/125A. Düz Fiş              | IP67 | 1    | 8    | 4.625,00 TL |
| BCS-6504-7312 | 4/125A. Uzatma Priz          | IP67 | 1    | 8    | 4.723,00 TL |
| BCS-6504-7413 | 4/125A. Makine Priz          | IP67 | 1    | 8    | 4.567,00 TL |
| BCS-6504-7114 | 4/125A. Makine Fişi          | IP67 | 1    | 8    | 4.567,00 TL |
| BCS-6504-7420 | 4/125A. 45° Eğik Makine Priz | IP67 | 1    | 8    | 4.567,00 TL |



## 5/125A. (3P+E+N) 380V. 50/60 Hz. 6h (Polyamid 6)

| Ürün Kodu     | Açıklama                     | IP   | Kutu | Koli | Fiyat       |
|---------------|------------------------------|------|------|------|-------------|
| BCS-6505-7011 | 5/125A. Düz Fiş              | IP67 | 1    | 8    | 4.717,00 TL |
| BCS-6505-7312 | 5/125A. Uzatma Priz          | IP67 | 1    | 8    | 4.831,00 TL |
| BCS-6505-7413 | 5/125A. Makine Priz          | IP67 | 1    | 8    | 4.678,00 TL |
| BCS-6505-7114 | 5/125A. Makine Fişi          | IP67 | 1    | 8    | 4.678,00 TL |
| BCS-6505-7420 | 5/125A. 45° Eğik Makine Priz | IP67 | 1    | 8    | 4.678,00 TL |



## Işık yansıtma mat hammadde



## Enversör Connector®

### Enversör Fiş

Seyyar makinelerde ters dönme sorunu yaşanır, Enversör fiş ile 5 saniyede tornavida yardımı ile sorunu çözün.

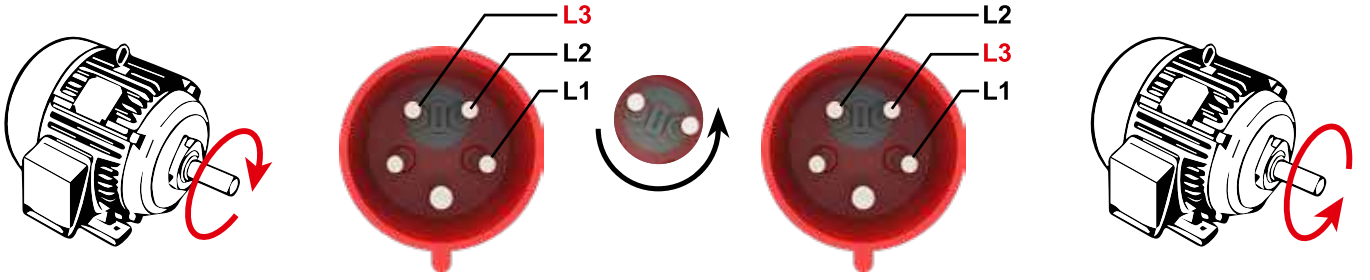

3 Fazlı motorlarda faz sıralamasının değişimi Enversör fiş ile 5 saniyede yapılır. (Polyamid 6)

**5/16A.** BC1-1505-2050  
**5/32A.** BC1-3505-2050



IP44

**5/16A.** BC1-1505-2080  
**5/32A.** BC1-3505-2080



IP44

**5/16A.** BC1-1505-2070  
**5/32A.** BC1-3505-2070



IP44

**5/16A.** BC1-1505-2060  
**5/32A.** BC1-3505-2060



IP44

**5/16A.** BC1-1505-7050  
**5/32A.** BC1-3505-7050



IP67

**5/16A.** BC1-1505-7070  
**5/32A.** BC1-3505-7070



IP67

**5/16A.** BC1-1505-7060  
**5/32A.** BC1-3505-7060



IP67

**5/16A.** BC1-1505-2061  
**5/32A.** BC1-3505-2061

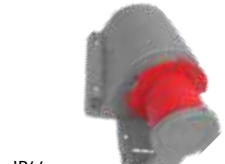

IP44

100  
yüzde  
yerli...

**B** bemis

5 YIL  
GARANTİ

24 Volt

24 Volt  
CEE Norm Fiş Priz Serisi

YERLİ  
ÜRETİM



Üreten Ülke Güçlüdür

24V  
CEE Norm



| Ürün Kodu     | Açıklama                       | IP   | Kutu | Koli | Fiyat     |
|---------------|--------------------------------|------|------|------|-----------|
| BC1-1102-2011 | 2/16A. Düz Fiş                 | IP44 | 10   | 120  | 442,00 TL |
| BC1-1102-2312 | 2/16A. Uzatma Priz             | IP44 | 10   | 120  | 540,00 TL |
| BC1-1102-2414 | 2/16A. Makine Priz (Tek Parça) | IP44 | 20   | 160  | 452,00 TL |
| BC1-1102-2413 | 2/16A. Makine Priz             | IP44 | 15   | 120  | 471,00 TL |
| BC1-1102-2114 | 2/16A. Makine Fişi             | IP44 | 10   | 120  | 520,00 TL |
| BC1-1102-2210 | 2/16A. Duvar Fiş               | IP44 | 6    | 72   | 638,00 TL |
| BC1-1102-2236 | 2/16A. 90° Eğik Duvar Fiş      | IP44 | 6    | 48   | 736,00 TL |
| BC1-1102-2510 | 2/16A. Duvar Priz              | IP44 | 6    | 72   | 638,00 TL |
| BC1-1102-2535 | 2/16A. 90° Eğik Duvar Priz     | IP44 | 3    | 36   | 736,00 TL |



| Ürün Kodu     | Açıklama                       | IP   | Kutu | Koli | Fiyat       |
|---------------|--------------------------------|------|------|------|-------------|
| BC1-1102-7011 | 2/16A. Düz Fiş                 | IP67 | 8    | 96   | 540,00 TL   |
| BC1-1102-7312 | 2/16A. Uzatma Priz             | IP67 | 8    | 96   | 687,00 TL   |
| BC1-1102-7414 | 2/16A. Makine Priz (Tek Parça) | IP67 | 8    | 96   | 638,00 TL   |
| BC1-1102-7413 | 2/16A. Makine Priz             | IP67 | 8    | 96   | 648,00 TL   |
| BC1-1102-7114 | 2/16A. Makine Fişi             | IP67 | 8    | 96   | 687,00 TL   |
| BC1-1102-7210 | 2/16A. Duvar Fiş               | IP67 | 4    | 48   | 883,00 TL   |
| BC1-1102-7236 | 2/16A. 90° Eğik Duvar Fiş      | IP67 | 3    | 36   | 1.079,00 TL |
| BC1-1102-7510 | 2/16A. Duvar Priz              | IP67 | 4    | 48   | 883,00 TL   |
| BC1-1102-7535 | 2/16A. 90° Eğik Duvar Priz     | IP67 | 3    | 36   | 1.079,00 TL |



| Ürün Kodu     | Açıklama                       | IP   | Kutu | Koli | Fiyat     |
|---------------|--------------------------------|------|------|------|-----------|
| BC1-1103-2011 | 3/16A. Düz Fiş                 | IP44 | 10   | 120  | 491,00 TL |
| BC1-1103-2312 | 3/16A. Uzatma Priz             | IP44 | 10   | 120  | 589,00 TL |
| BC1-1103-2414 | 3/16A. Makine Priz (Tek Parça) | IP44 | 20   | 160  | 491,00 TL |
| BC1-1103-2413 | 3/16A. Makine Priz             | IP44 | 15   | 120  | 510,00 TL |
| BC1-1103-2114 | 3/16A. Makine Fişi             | IP44 | 10   | 120  | 569,00 TL |
| BC1-1103-2210 | 3/16A. Duvar Fiş               | IP44 | 6    | 72   | 687,00 TL |
| BC1-1103-2236 | 3/16A. 90° Eğik Duvar Fiş      | IP44 | 6    | 48   | 785,00 TL |
| BC1-1103-2510 | 3/16A. Duvar Priz              | IP44 | 6    | 72   | 687,00 TL |
| BC1-1103-2535 | 3/16A. 90° Eğik Duvar Priz     | IP44 | 3    | 36   | 785,00 TL |



| Ürün Kodu     | Açıklama                       | IP   | Kutu | Koli | Fiyat       |
|---------------|--------------------------------|------|------|------|-------------|
| BC1-1103-7011 | 3/16A. Düz Fiş                 | IP67 | 8    | 96   | 627,00 TL   |
| BC1-1103-7312 | 3/16A. Uzatma Priz             | IP67 | 8    | 96   | 736,00 TL   |
| BC1-1103-7414 | 3/16A. Makine Priz (Tek Parça) | IP67 | 8    | 96   | 687,00 TL   |
| BC1-1103-7413 | 3/16A. Makine Priz             | IP67 | 8    | 96   | 697,00 TL   |
| BC1-1103-7114 | 3/16A. Makine Fişi             | IP67 | 8    | 96   | 736,00 TL   |
| BC1-1103-7210 | 3/16A. Duvar Fiş               | IP67 | 4    | 48   | 932,00 TL   |
| BC1-1103-7236 | 3/16A. 90° Eğik Duvar Fiş      | IP67 | 3    | 36   | 1.128,00 TL |
| BC1-1103-7510 | 3/16A. Duvar Priz              | IP67 | 4    | 48   | 932,00 TL   |
| BC1-1103-7535 | 3/16A. 90° Eğik Duvar Priz     | IP67 | 3    | 36   | 1.128,00 TL |





| Ürün Kodu     | Açıklama                       | IP   | Kutu | Koli | Fiyat     |
|---------------|--------------------------------|------|------|------|-----------|
| BC1-3102-2011 | 2/32A. Düz Fiş                 | IP44 | 10   | 120  | 520,00 TL |
| BC1-3102-2312 | 2/32A. Uzatma Priz             | IP44 | 10   | 120  | 618,00 TL |
| BC1-3102-2414 | 2/32A. Makine Priz (Tek Parça) | IP44 | 20   | 160  | 510,00 TL |
| BC1-3102-2413 | 2/32A. Makine Priz             | IP44 | 15   | 120  | 530,00 TL |
| BC1-3102-2114 | 2/32A. Makine Fişi             | IP44 | 10   | 120  | 599,00 TL |
| BC1-3102-2210 | 2/32A. Duvar Fiş               | IP44 | 6    | 72   | 756,00 TL |
| BC1-3102-2236 | 2/32A. 90° Eğik Duvar Fiş      | IP44 | 6    | 48   | 883,00 TL |
| BC1-3102-2510 | 2/32A. Duvar Priz              | IP44 | 6    | 72   | 756,00 TL |
| BC1-3102-2535 | 2/32A. 90° Eğik Duvar Priz     | IP44 | 3    | 36   | 883,00 TL |



| Ürün Kodu     | Açıklama                       | IP   | Kutu | Koli | Fiyat       |
|---------------|--------------------------------|------|------|------|-------------|
| BC1-3102-7011 | 2/32A. Düz Fiş                 | IP67 | 8    | 96   | 736,00 TL   |
| BC1-3102-7312 | 2/32A. Uzatma Priz             | IP67 | 8    | 96   | 883,00 TL   |
| BC1-3102-7414 | 2/32A. Makine Priz (Tek Parça) | IP67 | 8    | 96   | 736,00 TL   |
| BC1-3102-7413 | 2/32A. Makine Priz             | IP67 | 8    | 96   | 756,00 TL   |
| BC1-3102-7114 | 2/32A. Makine Fişi             | IP67 | 8    | 96   | 962,00 TL   |
| BC1-3102-7210 | 2/32A. Duvar Fiş               | IP67 | 4    | 48   | 1.158,00 TL |
| BC1-3102-7236 | 2/32A. 90° Eğik Duvar Fiş      | IP67 | 3    | 36   | 1.226,00 TL |
| BC1-3102-7510 | 2/32A. Duvar Priz              | IP67 | 4    | 48   | 1.158,00 TL |
| BC1-3102-7535 | 2/32A. 90° Eğik Duvar Priz     | IP67 | 3    | 36   | 1.226,00 TL |



| Ürün Kodu     | Açıklama                       | IP   | Kutu | Koli | Fiyat     |
|---------------|--------------------------------|------|------|------|-----------|
| BC1-3103-2011 | 3/32A. Düz Fiş                 | IP44 | 10   | 120  | 569,00 TL |
| BC1-3103-2312 | 3/32A. Uzatma Priz             | IP44 | 10   | 120  | 667,00 TL |
| BC1-3103-2414 | 3/32A. Makine Priz (Tek Parça) | IP44 | 20   | 160  | 559,00 TL |
| BC1-3103-2413 | 3/32A. Makine Priz             | IP44 | 15   | 120  | 579,00 TL |
| BC1-3103-2114 | 3/32A. Makine Fişi             | IP44 | 10   | 120  | 648,00 TL |
| BC1-3103-2210 | 3/32A. Duvar Fiş               | IP44 | 6    | 72   | 834,00 TL |
| BC1-3103-2236 | 3/32A. 90° Eğik Duvar Fiş      | IP44 | 6    | 48   | 962,00 TL |
| BC1-3103-2510 | 3/32A. Duvar Priz              | IP44 | 6    | 72   | 814,00 TL |
| BC1-3103-2535 | 3/32A. 90° Eğik Duvar Priz     | IP44 | 3    | 36   | 962,00 TL |



| Ürün Kodu     | Açıklama                       | IP   | Kutu | Koli | Fiyat       |
|---------------|--------------------------------|------|------|------|-------------|
| BC1-3103-7011 | 3/32A. Düz Fiş                 | IP67 | 8    | 96   | 736,00 TL   |
| BC1-3103-7312 | 3/32A. Uzatma Priz             | IP67 | 8    | 96   | 932,00 TL   |
| BC1-3103-7414 | 3/32A. Makine Priz (Tek Parça) | IP67 | 8    | 96   | 765,00 TL   |
| BC1-3103-7413 | 3/32A. Makine Priz             | IP67 | 8    | 96   | 785,00 TL   |
| BC1-3103-7114 | 3/32A. Makine Fişi             | IP67 | 8    | 96   | 834,00 TL   |
| BC1-3103-7210 | 3/32A. Duvar Fiş               | IP67 | 4    | 48   | 932,00 TL   |
| BC1-3103-7236 | 3/32A. 90° Eğik Duvar Fiş      | IP67 | 3    | 36   | 1.275,00 TL |
| BC1-3103-7510 | 3/32A. Duvar Priz              | IP67 | 4    | 48   | 1.207,00 TL |
| BC1-3103-7535 | 3/32A. 90° Eğik Duvar Priz     | IP67 | 3    | 36   | 1.275,00 TL |



**YENİ**  
**POWERBOX**  
**SERİSİ**



**B** bemis

**YERLİ  
ÜRETİM**



100  
yüzde  
yerli...

**B** bemis

5 YIL  
GARANTİ

**BEMBOX**

YERLİ  
ÜRETİM

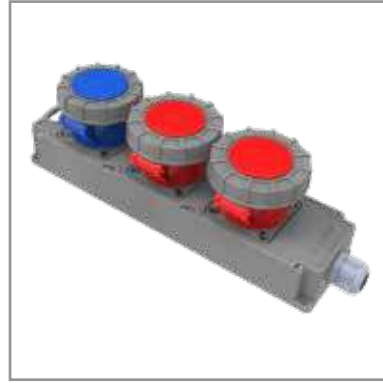

Üreten Ülke Güçlüdür

(Polyamid 6) Gövde



| Ürün Kodu     | Açıklama   | IP   | Kutu | Koli | Fiyat       |
|---------------|--|------|------|------|-------------|
| BG4-100X-0X0X | Grup Priz Kutusu (Deliksiz)                                  | IP44 | 1    | 24   | 552,50 TL   |
| BG4-100Y-0Y0Y | Grup Priz Kutusu (Büyük Delikli)                             | IP44 | 1    | 24   | 552,50 TL   |
| BG4-1010-1010 | 1/16A. 220V. 3 Ad.   | IP44 | 1    | 12   | 1.264,50 TL |
| BG4-1014-1414 | 3/16A. 220V. 3 Ad.   | IP44 | 1    | 12   | 1.548,75 TL |
| BG4-1016-1010 | 5/16A. 380V. 1 Ad. + 1/16A. 220V. 2 Ad.                      | IP44 | 1    | 12   | 1.591,50 TL |
| BG4-1016-1610 | 5/16A. 380V. 2 Ad. + 1/16A. 220V. 1 Ad.                      | IP44 | 1    | 12   | 1.917,63 TL |
| BG4-1016-1614 | 5/16A. 380V. 2 Ad. + 3/16A. 220V. 1 Ad.                      | IP44 | 1    | 12   | 2.013,00 TL |
| BG4-1016-1616 | 5/16A. 380V. 3 Ad.   | IP44 | 1    | 12   | 2.244,63 TL |
| BG4-1017-1717 | 3/32A. 220V. 3 Ad.   | IP44 | 1    | 12   | 1.973,75 TL |
| BG4-1018-1818 | 4/32A. 380V. 3 Ad.   | IP44 | 1    | 12   | 2.220,63 TL |
| BG4-1019-1010 | 5/32A. 380V. 1 Ad. + 1/16A. 220V. 2 Ad.                      | IP44 | 1    | 12   | 1.675,38 TL |
| BG4-1019-1514 | 5/32A. 380V. 1 Ad. + 4/16A. 380V. 1 Ad. + 3/16A. 220V. 1 Ad. | IP44 | 1    | 12   | 1.982,63 TL |
| BG4-1019-1614 | 5/32A. 380V. 1 Ad. + 5/16A. 380V. 1 Ad. + 3/16A. 220V. 1 Ad. | IP44 | 1    | 12   | 2.096,75 TL |
| BG4-1019-1910 | 5/32A. 380V. 2 Ad. + 1/16A. 220V. 1 Ad.                      | IP44 | 1    | 12   | 2.086,88 TL |
| BG4-1019-1914 | 5/32A. 380V. 2 Ad. + 3/16A. 220V. 1 Ad.                      | IP44 | 1    | 12   | 2.181,38 TL |
| BG4-1019-1916 | 5/32A. 380V. 2 Ad. + 5/16A. 380V. 1 Ad.                      | IP44 | 1    | 12   | 2.413,00 TL |
| BG4-1019-1917 | 5/32A. 380V. 2 Ad. + 3/32A. 220V. 1 Ad.                      | IP44 | 1    | 12   | 2.323,00 TL |
| BG4-1019-1919 | 5/32A. 380V. 3 Ad.   | IP44 | 1    | 12   | 2.497,75 TL |
| BG4-101K-1K1K | 2/16A. 24V. 3 Ad.  | IP44 | 1    | 12   | 2.348,00 TL |
| BG4-101L-1K1K | 3/16A. 24V. 1 Ad. + 2/16A. 24V. 2 Ad.                        | IP44 | 1    | 12   | 2.649,13 TL |
| BG4-101L-1L1L | 3/16A. 24V. 3 Ad.  | IP44 | 1    | 12   | 2.869,25 TL |
| BG4-101M-1K1K | 2/32A. 24V. 1 Ad. + 2/16A. 24V. 2 Ad.                        | IP44 | 1    | 12   | 2.446,88 TL |
| BG4-101M-1M1M | 2/32A. 24V. 3 Ad.  | IP44 | 1    | 12   | 2.645,63 TL |
| BG4-101N-1L1L | 3/32A. 24V. 1 Ad. + 3/16A. 24V. 2 Ad.                        | IP44 | 1    | 12   | 2.989,50 TL |
| BG4-101N-1M1M | 3/32A. 24V. 1 Ad. + 2/32A. 24V. 2 Ad.                        | IP44 | 1    | 12   | 2.840,75 TL |
| BG4-101N-1N1N | 3/32A. 24V. 3 Ad.  | IP44 | 1    | 12   | 3.230,13 TL |
| BG4-101T-1T1T | 1/16A. 220V. 3 Ad. Termal Sigortalı                          | IP44 | 1    | 12   | 1.359,00 TL |
| BG4-111Y-1Y1Y | Grup Priz Kutusu Sarı (Büyük Delikli)                        | IP44 | 1    | 24   | 588,13 TL   |



Not: Sarı renk grup priz kutusu ürünümüz minimum 100 Ad. siparişe göre üretilir.

(Polyamid 6) G6vde

| Ürün Kodu     | Açıklama   | IP   | Kutu | Koli | Fiyat       |
|---------------|--|------|------|------|-------------|
| BG6-100X-0X0X | Grup Priz Kutusu (Deliksiz)                                  | IP67 | 1    | 24   | 623,75 TL   |
| BG6-1010-1010 | 1/16A. 220V. 3 Ad.   | IP67 | 1    | 12   | 2.344,50 TL |
| BG6-1014-1414 | 3/16A. 220V. 3 Ad.   | IP67 | 1    | 12   | 2.066,38 TL |
| BG6-1016-1010 | 5/16A. 380V. 1 Ad. + 1/16A. 220V. 2 Ad.                      | IP67 | 1    | 12   | 2.474,63 TL |
| BG6-1016-1410 | 5/16A. 380V. 1 Ad. + 3/16A. 220V. 1 Ad. + 1/16A. 220V. 1 Ad. | IP67 | 1    | 12   | 2.381,88 TL |
| BG6-1016-1610 | 5/16A. 380V. 2 Ad. + 1/16A. 220V. 1 Ad.                      | IP67 | 1    | 12   | 2.603,75 TL |
| BG6-1016-1614 | 5/16A. 380V. 2 Ad. + 3/16A. 220V. 1 Ad.                      | IP67 | 1    | 12   | 2.512,00 TL |
| BG6-1016-1616 | 5/16A. 380V. 3 Ad.   | IP67 | 1    | 12   | 2.733,75 TL |
| BG6-1017-1717 | 3/32A. 220V. 3 Ad.   | IP67 | 1    | 12   | 2.498,63 TL |
| BG6-1018-1818 | 4/32A. 380V. 3 Ad.   | IP67 | 1    | 12   | 2.749,00 TL |
| BG6-1019-1010 | 5/32A. 380V. 1 Ad. + 1/16A. 220V. 2 Ad.                      | IP67 | 1    | 12   | 2.566,38 TL |
| BG6-1019-1910 | 5/32A. 380V. 2 Ad. + 1/16A. 220V. 1 Ad.                      | IP67 | 1    | 12   | 2.788,13 TL |
| BG6-1019-1914 | 5/32A. 380V. 2 Ad. + 3/16A. 220V. 1 Ad.                      | IP67 | 1    | 12   | 2.695,50 TL |
| BG6-1019-1916 | 5/32A. 380V. 2 Ad. + 5/16A. 380V. 1 Ad.                      | IP67 | 1    | 12   | 2.918,25 TL |
| BG6-1019-1917 | 5/32A. 380V. 2 Ad. + 3/32A. 220V. 1 Ad.                      | IP67 | 1    | 12   | 2.839,00 TL |
| BG6-1019-1919 | 5/32A. 380V. 3 Ad.   | IP67 | 1    | 12   | 3.010,13 TL |
| BG6-101K-1K1K | 2/16A. 24V. 3 Ad.  | IP67 | 1    | 12   | 3.088,50 TL |
| BG6-101L-1K1K | 3/16A. 24V. 1 Ad. + 2/16A. 24V. 2 Ad.                        | IP67 | 1    | 12   | 3.315,75 TL |
| BG6-101L-1L1L | 3/16A. 24V. 3 Ad.  | IP67 | 1    | 12   | 3.768,38 TL |
| BG6-101M-1K1K | 2/32A. 24V. 1 Ad. + 2/16A. 24V. 2 Ad.                        | IP67 | 1    | 12   | 3.215,88 TL |
| BG6-101M-1M1M | 2/32A. 24V. 3 Ad.  | IP67 | 1    | 12   | 3.471,63 TL |
| BG6-101N-1L1L | 3/32A. 24V. 1 Ad. + 3/16A. 24V. 2 Ad.                        | IP67 | 1    | 12   | 3.918,00 TL |
| BG6-101N-1M1M | 3/32A. 24V. 1 Ad. + 2/32A. 24V. 2 Ad.                        | IP67 | 1    | 12   | 3.719,38 TL |
| BG6-101N-1N1N | 3/32A. 24V. 3 Ad.  | IP67 | 1    | 12   | 4.215,63 TL |



# KARMAŞAYA SON

Hava hortumları ve elektrik kablolarını havadan kullanma imkanı



**B**  
**bemis**<sup>®</sup>



TÜRKİYE'DE İLK

**Polybox**<sup>®</sup>

| Ürün Kodu     | Açıklama  | IP   | Kutu | Koli | Fiyat       |
|---------------|---|------|------|------|-------------|
| BX1-0000-0000 | CEE Norm Prizsiz Box                                    | IP44 | 1    | 6    | 637,63 TL   |
| BX1-0111-0000 | CEE Norm 1/16A. 3 Ad. Box                               | IP44 | 1    | 6    | 1.331,00 TL |
| BX1-0TTT-0000 | CEE Norm 1/16A. 3 Ad. Termal Sigortalı Box              | IP44 | 1    | 6    | 1.525,13 TL |
| BX1-0222-0000 | CEE Norm 3/16A. 3 Ad. Box                               | IP44 | 1    | 6    | 1.836,50 TL |
| BX1-0222-2100 | CEE Norm IP44 3/16A 3AD. 1/16A 2AD BOX                  | IP44 | 1    | 6    | 2.164,00 TL |
| BX1-0333-0000 | CEE Norm 4/16A. 3 Ad. Box                               | IP44 | 1    | 6    | 2.206,88 TL |
| BX1-0333-2100 | CEE Norm 4/16A. 3 Ad. + 1/16A. 2 Ad. Box                | IP44 | 1    | 6    | 2.643,13 TL |
| BX1-0441-0000 | CEE Norm 5/16A. 2 Ad. + 1/16A. 1 Ad. Box                | IP44 | 1    | 6    | 2.224,75 TL |
| BX1-0444-0000 | CEE Norm 5/16A. 3 Ad. Box                               | IP44 | 1    | 6    | 2.569,13 TL |
| BX1-0444-2100 | CEE Norm 5/16A. 3 Ad. + 1/16A. 2 Ad. Box                | IP44 | 1    | 6    | 3.006,13 TL |
| BX1-0442-2100 | CEE Norm 5/16A. 2 Ad. + 3/16A. 1 Ad. + 1/16A. 2 Ad. Box | IP44 | 1    | 6    | 2.761,38 TL |
| BX1-0555-0000 | CEE Norm 3/32A. 3 Ad. Box                               | IP44 | 1    | 6    | 2.283,88 TL |
| BX1-0666-0000 | CEE Norm 4/32A. 3 Ad. Box                               | IP44 | 1    | 6    | 2.543,75 TL |
| BX1-0666-2100 | CEE Norm 4/32A. 3 Ad. + 1/16A. 2 Ad. Box                | IP44 | 1    | 6    | 2.980,75 TL |
| BX1-0771-0000 | CEE Norm 5/32A. 2 Ad. + 1/16A. 1 Ad. Box                | IP44 | 1    | 6    | 2.403,13 TL |
| BX1-0777-0000 | CEE Norm 5/32A. 3 Ad. Box                               | IP44 | 1    | 6    | 2.835,38 TL |
| BX1-0777-2100 | CEE Norm 5/32A. 3 Ad. + 1/16A. 2 Ad. Box                | IP44 | 1    | 6    | 3.271,63 TL |
| BX1-0777-7210 | CEE Norm IP44 5/32A 4AD.1/16A 2AD BOX                   | IP44 | 1    | 6    | 3.881,00 TL |
| BX1-0KKK-0000 | CEE Norm 2/16A. 24V. 3 Ad. Box                          | IP44 | 1    | 6    | 2.677,75 TL |
| BX1-0LLL-0000 | CEE Norm 3/16A. 24V. 3 Ad. Box                          | IP44 | 1    | 6    | 3.226,50 TL |
| BX1-0MMM-0000 | CEE Norm 2/32A. 24V. 3 Ad. Box                          | IP44 | 1    | 6    | 2.991,13 TL |
| BX1-0NNN-0000 | CEE Norm 3/32A. 24V. 3 Ad. Box                          | IP44 | 1    | 6    | 3.606,50 TL |

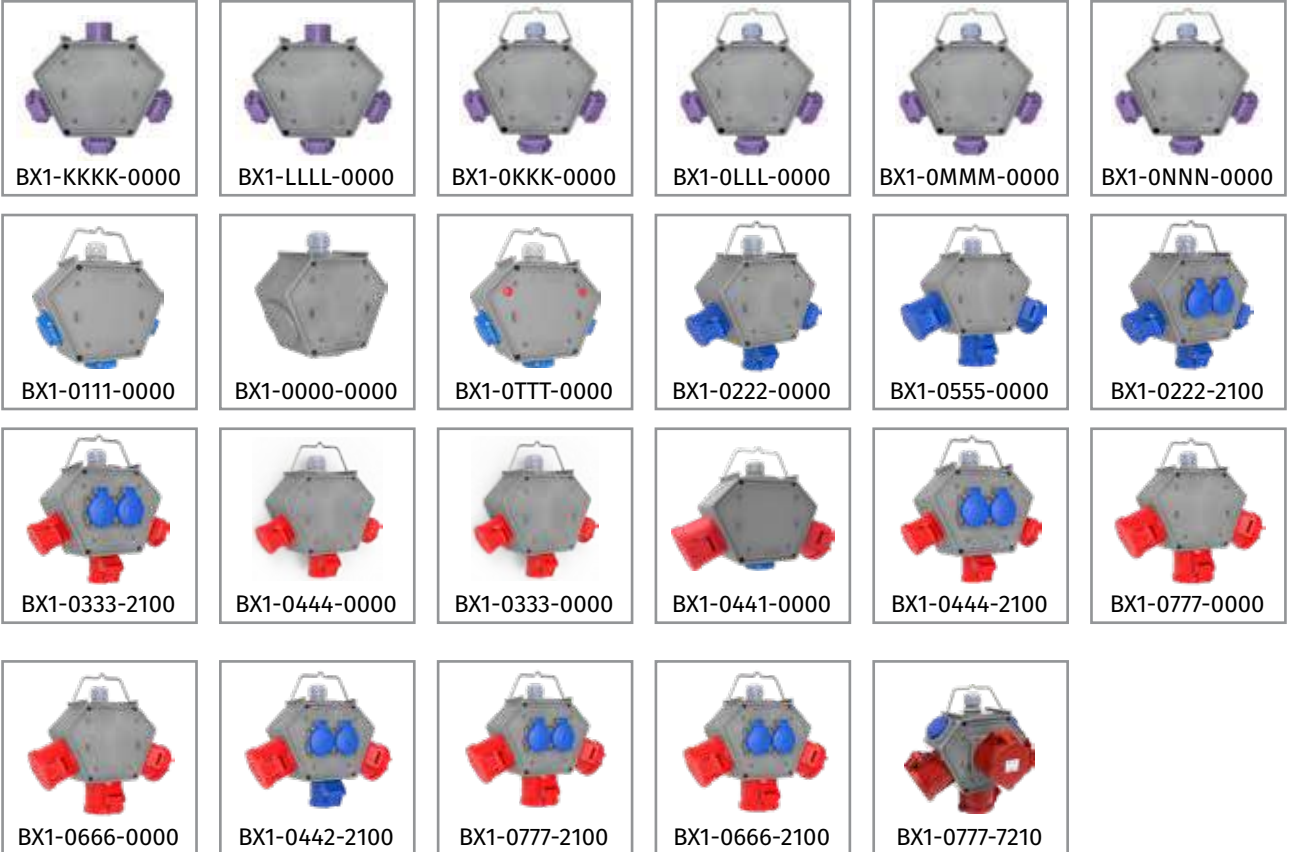

## FİŞLİ POLYBOX

(Polyamid 6) Gövde

| Ürün Kodu     | Açıklama  | IP   | Kutu | Koli | Fiyat       |
|---------------|---|------|------|------|-------------|
| BX1-1222-0000 | CEE Norm 3/16A. 3 Ad. + 3/32A. Fişli Box                | IP44 | 1    | 6    | 2.334,63 TL |
| BX1-1222-2100 | CEE Norm 3/16A. 3 Ad. + 1/16A. 2 Ad. + 3/32A. Fişli Box | IP44 | 1    | 6    | 2.834,50 TL |
| BX1-3444-0000 | CEE Norm 5/16A. 3 Ad. + 5/32A. Fişli Box                | IP44 | 1    | 6    | 3.251,00 TL |
| BX1-7444-0000 | CEE Norm 5/16A. 3 Ad. + 5/16A. Fişli Box                | IP44 | 1    | 6    | 3.152,50 TL |
| BX1-KKKK-0000 | CEE Norm 2/16A. 24V. 3 Ad. + 2/16A. 24V. Fişli Box      | IP44 | 1    | 6    | 3.326,88 TL |
| BX1-LLLL-0000 | CEE Norm 3/16A. 24V. 3 Ad. + 3/16A. 24V. Fişli Box      | IP44 | 1    | 6    | 3.979,75 TL |

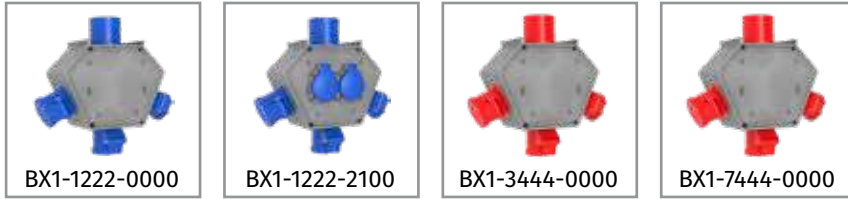

## KABLOLU POLYBOX

(Polyamid 6) Gövde

| Ürün Kodu     | Açıklama  | IP   | Kutu | Koli | Fiyat       |
|---------------|---|------|------|------|-------------|
| BX1K0333-2100 | CEE Norm 4/16A. 3 Ad. + 1/16A. 2 Ad. 1,5m Kablolu Box               | IP44 | 1    | 6    | 3.239,63 TL |
| BX1K0444-2100 | CEE Norm 5/16A. 3 Ad. + 1/16A. 2 Ad. + 1,5m Kablolu Box             | IP44 | 1    | 6    | 3.602,63 TL |
| BX1K3444-4000 | CEE Norm 5/16A. 4 Ad. + 5/32A. 1 Ad. Fişli + 1,5m Kablolu           | IP44 | 1    | 6    | 4.126,00 TL |
| BX1K0777-0000 | CEE Norm 5/32A. 3 Ad. + 1,5m Kablolu Box                            | IP44 | 1    | 6    | 3.432,00 TL |
| BX1K0550-2113 | CEE Norm 3/32A. 2 Ad. + 1/16A. 2 Ad. + 1,5m Kab. 3 Hava Çıkışlı Box | IP44 | 1    | 6    | 4.758,25 TL |
| BX1K0660-2113 | CEE Norm 4/32A. 2 Ad. + 1/16A. 2 Ad. + 1,5m Kab. 3 Hava Çıkışlı Box | IP44 | 1    | 6    | 4.930,75 TL |
| BX1K0770-0013 | CEE Norm 5/32A. 2 Ad. + 1,5m Kablolu, 3 Hava Çıkışlı Box            | IP44 | 1    | 6    | 4.687,88 TL |



## HAVA ÇIKIŞLI POLYBOX

(Polyamid 6) Gövde

| Ürün Kodu     | Açıklama  | IP   | Kutu | Koli | Fiyat       |
|---------------|---|------|------|------|-------------|
| BX1-0110-2113 | CEE Norm 1/16A. 4 Ad. + 3 Hava Çıkışlı Box                | IP44 | 1    | 6    | 3.457,38 TL |
| BX1-0220-2113 | CEE Norm 3/16A. 2 Ad. + 1/16A. 2Ad. 3 Hava Çıkışlı Box    | IP44 | 1    | 6    | 3.863,38 TL |
| BX1-0222-2113 | CEE Norm 3/16A. 3 Ad. + 1/16A. 2 Ad. + 3 Hava Çıkışlı Box | IP44 | 1    | 6    | 4.213,38 TL |
| BX1-0330-2113 | CEE Norm 4/16A. 2 Ad. + 1/16A. 2 Ad. 3 Hava Çıkışlı Box   | IP44 | 1    | 6    | 4.288,25 TL |
| BX1-0440-2113 | CEE Norm 5/16A. 2 Ad. + 1/16A. 2 Ad. + 3 Hava Çıkışlı Box | IP44 | 1    | 6    | 4.351,13 TL |
| BX1-0777-2113 | CEE Norm 5/32A 3 Ad. 1/16A 2A Ad. 3 Hava Çıkışlı Box      | IP44 | 1    | 6    | 5.140,00 TL |
| BX1-0550-2113 | CEE Norm 3/32A. 2 Ad. + 1/16A. 2 Ad. + 3 Hava Çıkışlı Box | IP44 | 1    | 6    | 4.161,63 TL |
| BX1-0660-2113 | CEE Norm 4/32A. 2 Ad. + 1/16A. 2 Ad. + 3 Hava Çıkışlı Box | IP44 | 1    | 6    | 4.334,25 TL |

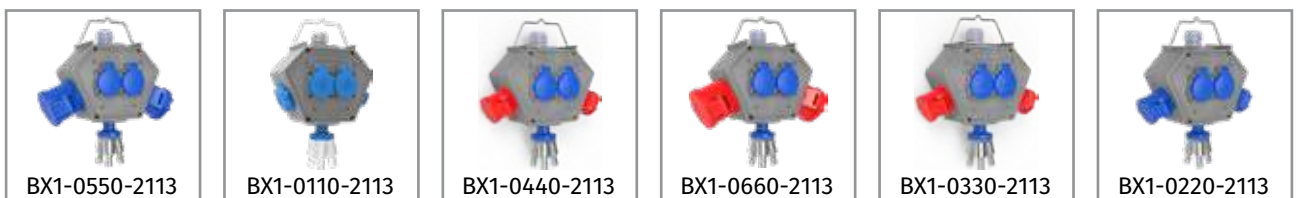

## 120x255x80mm



Termal Sigorta



PG16 / PG21  
Rekor



ABS



IP44



1

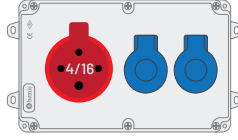

BKP-7215-2000  
1.287,00 TL

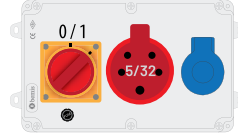

BKP-7219-1002  
2.881,00 TL

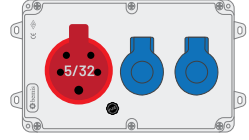

BKP-7219-2009  
1.631,00 TL

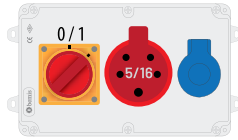

BKP-7216-1001  
1.880,00 TL

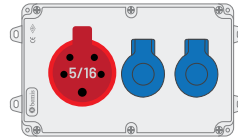

BKP-7216-2000  
1.426,00 TL

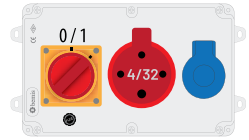

BKP-7218-1002  
2.735,00 TL

## 210x300x90mm



Termal Sigorta



PG16 / PG21  
Rekor



ABS



IP44



1

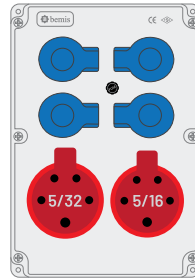
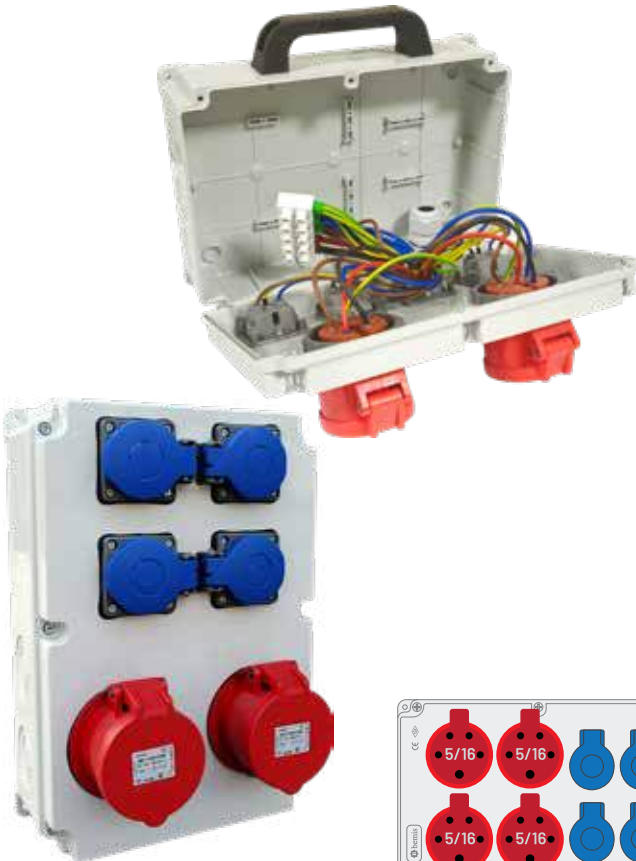

BKP-8296-4009  
3.017,00 TL

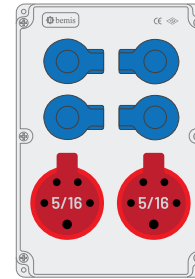

BKP-8226-4000  
2.373,00 TL

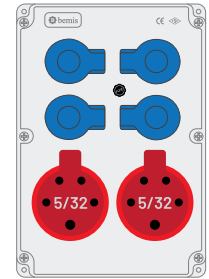

BKP-8229-4009  
2.635,00 TL

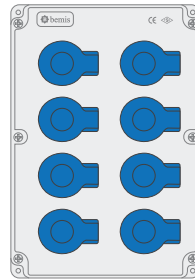

BKP-8280-0000  
2.055,00 TL

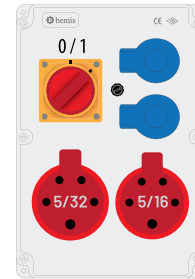

BKP-8296-2002  
3.600,00 TL

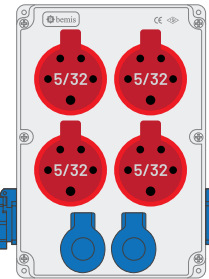

BKP-8249-4000  
3.821,00 TL

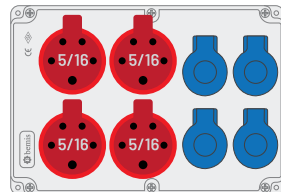

BKP-8246-4000  
3.464,00 TL

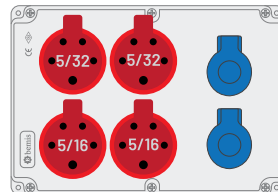

BKP-8229-2620  
3.264,00 TL

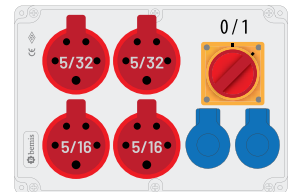

BKP-8229-2621  
4.405,00 TL





**KULPLU**  
**120x255x80mm**

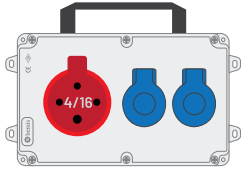

**BKP-7215-2007**  
**1.270,00 TL**

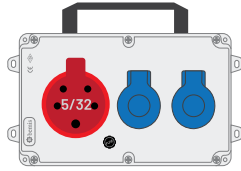

**BKP-7219-2003**  
**1.543,00 TL**

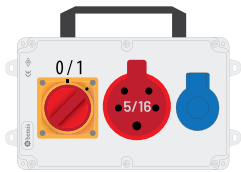

**BKP-7216-1008**  
**1.940,00 TL**

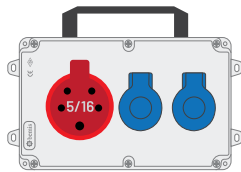

**BKP-7216-2007**  
**1.631,00 TL**

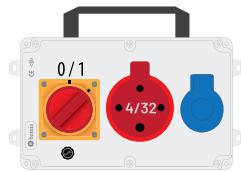

**BKP-7218-1004**  
**2.839,00 TL**



**KULPLU**  
**210x300x90mm**

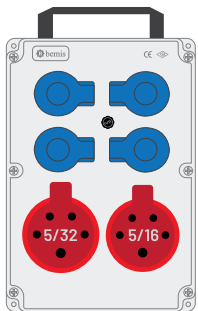

**BKP-8219-1643**  
**2.724,00 TL**

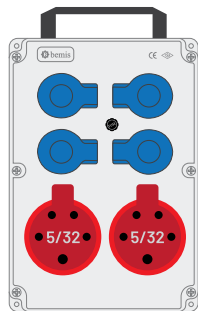

**BKP-8229-4003**  
**2.818,00 TL**

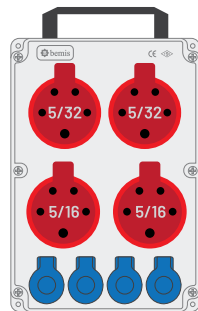

**BKP-8229-2647**  
**3.826,00 TL**

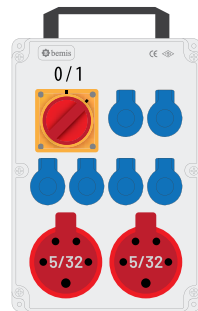

**BKP-8229-6008**  
**4.338,00 TL**

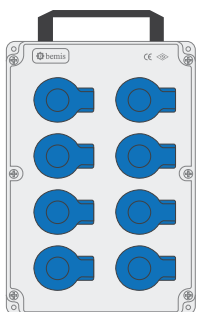

**BKP-8280-0007**  
**2.634,00 TL**

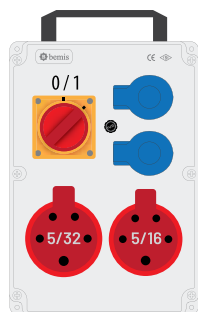

**BKP-8296-2004**  
**3.660,00 TL**

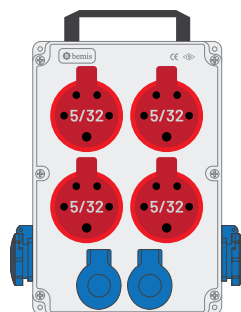

**BKP-8249-4007**  
**3.999,00 TL**

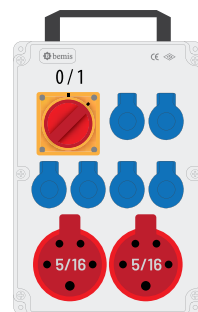

**BKP-8226-6008**  
**3.296,00 TL**

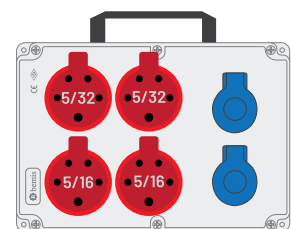

**BKP-8229-2627**  
**3.448,00 TL**



## KULPLU KABLOLU 120x255x80mm

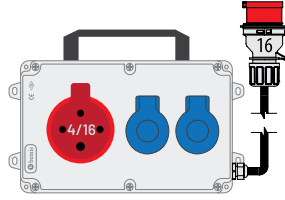
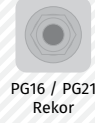
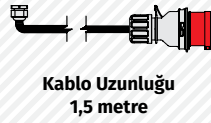

BKP77215-2007  
1.894,00 TL

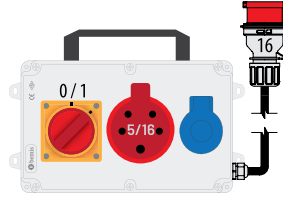

BKP7716-1008  
2.731,00 TL

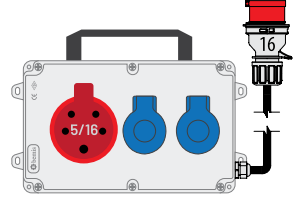

BKP77216-2007  
2.072,00 TL

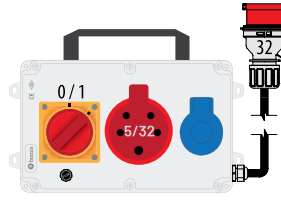

BKP37219-1004  
4.110,00 TL

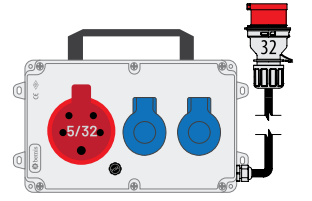

BKP37219-2003  
2.323,00 TL

## KULPLU KABLOLU 210x300x90mm

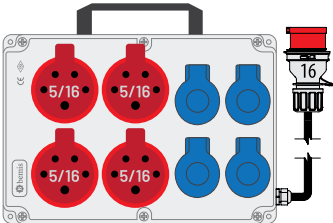
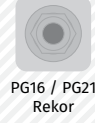
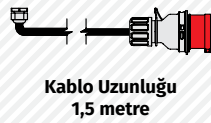

BKP78226-4007  
4.327,00 TL

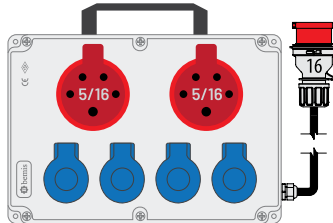

BKP78226-4005  
3.242,00 TL

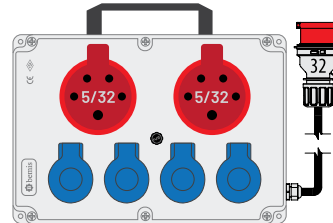

BKP38229-4003  
3.592,00 TL

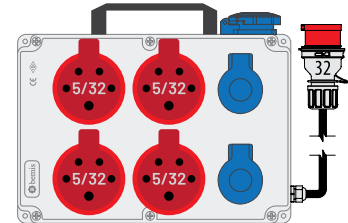

BKP38249-4007  
4.784,00 TL

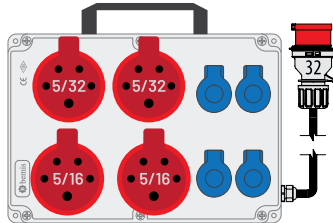

BKP38229-2647  
4.600,00 TL

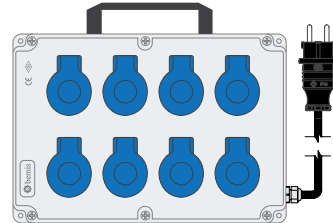

BKP98280-0007  
3.023,00 TL

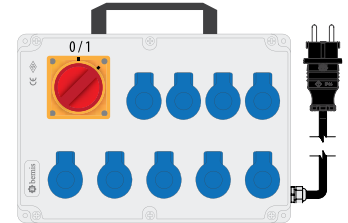

BKP98290-0008  
2.948,00 TL

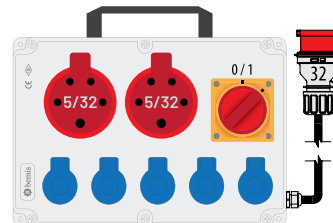

BKP38229-5008  
5.375,00 TL

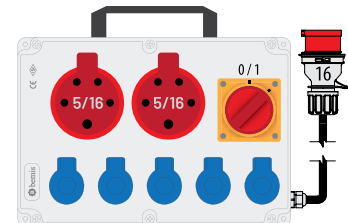

BKP78226-5008  
3.907,00 TL



Termal Sigorta



PG16 / PG21  
Rekor



ABS



IP44



1

## METAL AYAKLI KULPLU 210x300x90mm

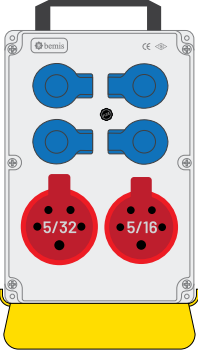

BKP-8296-4025  
3.286,00 TL

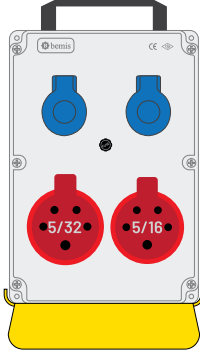

BKP-8296-2025  
2.907,00 TL

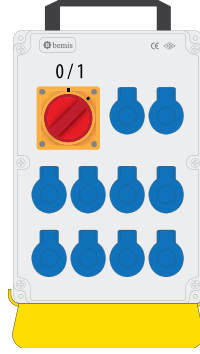

BKP-8250-5022  
3.319,00 TL

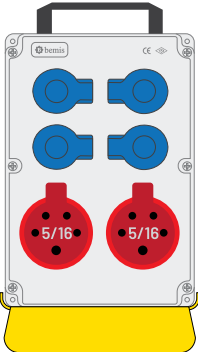

BKP-8226-4021  
3.108,00 TL

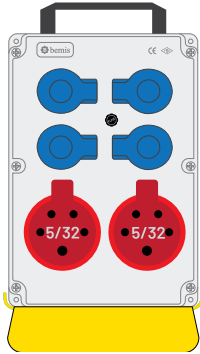

BKP-8229-4025  
3.375,00 TL

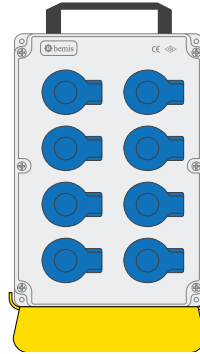

BKP-8280-0021  
3.287,00 TL

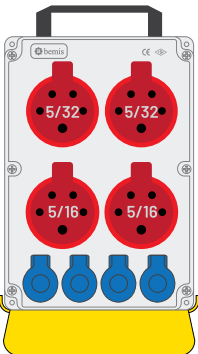

BKP-8229-26421  
4.383,00 TL

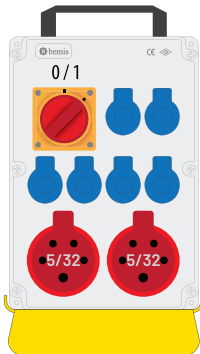

BKP-8229-6024  
4.585,00 TL

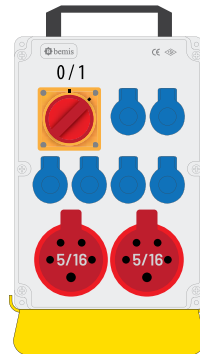

BKP-8226-6024  
3.708,00 TL



## METAL AYAKLI 210x300x90mm



Termal Sigorta



PG16 / PG21  
Rekor



ABS



IP44



1

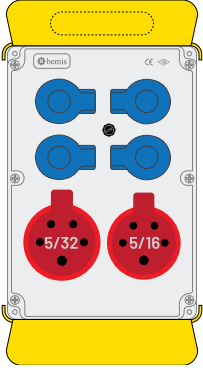

BKP-8296-4020  
3.514,00 TL

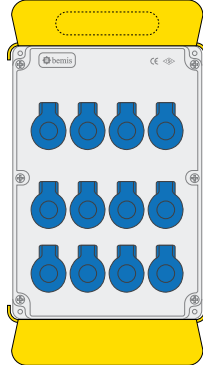

BKP-8260-6016  
4.455,00 TL

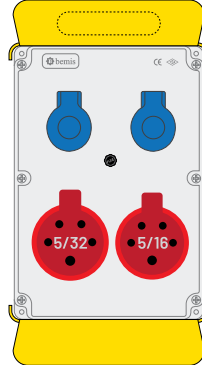

BKP-8296-2020  
3.136,00 TL

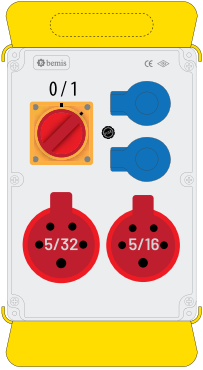

BKP-8296-2017  
4.132,00 TL

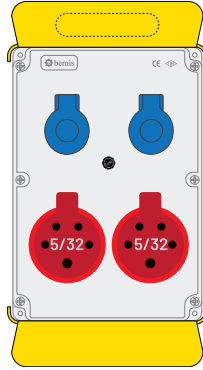

BKP-8229-2020  
3.230,00 TL

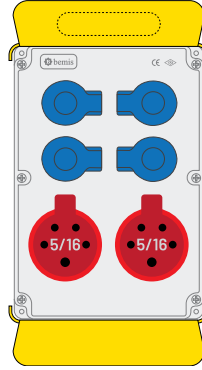

BKP-8226-4016  
3.342,00 TL

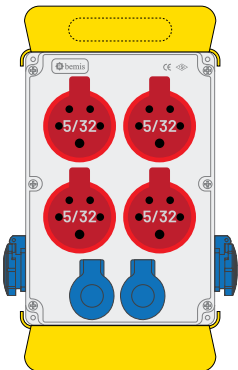

BKP-8249-4016  
4.801,00 TL



## BORU AYAKLI 210x300x90mm

Kablo Uzunluęu  
1,5 metre



Termal Sigorta



PG16 / PG21  
Rekor



ABS



IP44



1

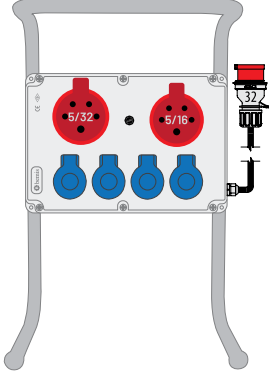

BKP38296-4011  
4.409,00 TL

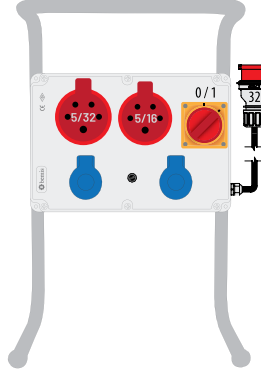

BKP38296-2013  
5.173,00 TL

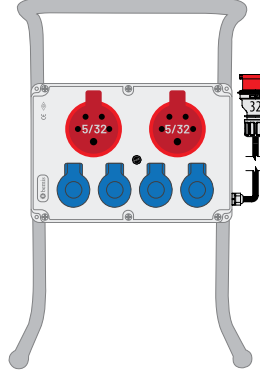

BKP38229-4011  
4.515,00 TL

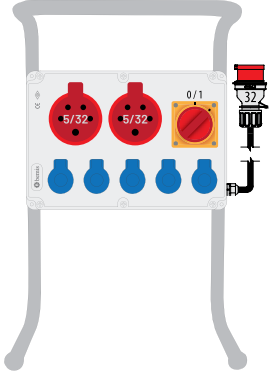

BKP38229-5015  
5.671,00 TL

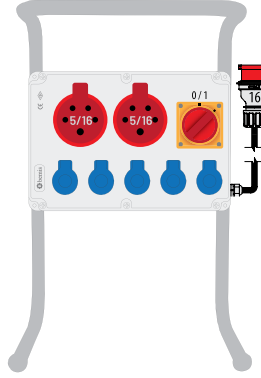

BKP78226-5015  
4.267,00 TL

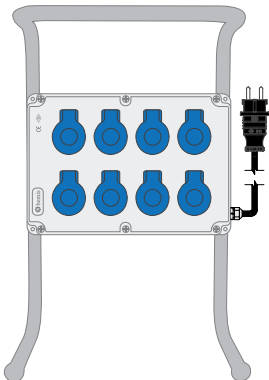

BKP98280-0012  
3.287,00 TL

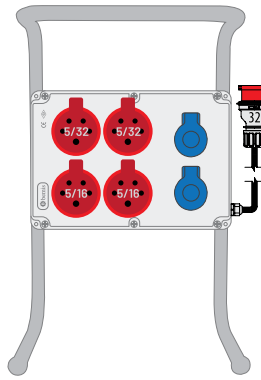

BKP38229-26212  
4.450,00 TL



## InterLock®

16A.



32A.



63A.



**CEE Norm  
Interlock Priz  
380V. 3P+E+N (ABS)**

| Ürün Kodu     | Açıklama                   | IP   | Kutu | Koli | Fiyat       |
|---------------|----------------------------|------|------|------|-------------|
| BC1-1403-7540 | 3/16A. 90° Eğik Duvar Priz | IP67 | 1    | 0    | 3.795,00 TL |
| BC1-1403-7560 | 3/16A. Düz Duvar Priz      | IP67 | 1    | 0    | 3.323,50 TL |
| BC1-1504-7540 | 4/16A. 90° Eğik Duvar Priz | IP67 | 1    | 0    | 3.910,00 TL |
| BC1-1504-7560 | 4/16A. Düz Duvar Priz      | IP67 | 1    | 0    | 3.381,00 TL |
| BC1-1505-7540 | 5/16A. 90° Eğik Duvar Priz | IP67 | 1    | 0    | 4.140,00 TL |
| BC1-1505-7560 | 5/16A. Düz Duvar Priz      | IP67 | 1    | 0    | 3.438,50 TL |
| BC1-3403-7540 | 3/32A. 90° Eğik Duvar Priz | IP67 | 1    | 0    | 4.140,00 TL |
| BC1-3504-7540 | 4/32A. 90° Eğik Duvar Priz | IP67 | 1    | 0    | 4.255,00 TL |
| BC1-3505-7540 | 5/32A. 90° Eğik Duvar Priz | IP67 | 1    | 0    | 4.485,00 TL |
| BC1-4504-7540 | 4/63A. 90° Eğik Duvar Priz | IP67 | 1    | 0    | 9.000,00 TL |
| BC1-4505-7540 | 5/63A. 90° Eğik Duvar Priz | IP67 | 1    | 0    | 9.200,00 TL |

**Hatalı kullanımı engelleyen, kendini ve cihazı koruyan priz**

Uluslararası Standartları; IEC 309-1 - IEC 309-2

Avrupa Standartları; En 60 309-1 - EN 60 309-2

Alev ve Yangın dayanımı, kızaran tel testinde 850 santigratı aşan değerler;

Mekanik kilitleme şalteri, sadece fiş girişi ile aktif olur.

Fiş, sadece şalter "Off" pozisyonuna geldiğinde çıkabilir.

Şalter IEC 60947 standardı ile uyumlu, AC 21, AC 22, AC 23 ile kullanılabilir.

Koruma sınıfı değeri IP67

Mekanik koruma değeri IK8





## Yüksek Akım Ürünlerin Genel Kullanım Alanları

### Temel Uygulama Alanları:

- Limanlar ve konteyner depolama
- Gemiler ve tersaneler
- Hareketli ve ağır yükler
- İnşaat alanları
- Tünel ve maden sahaları
- Ocaklar ve açık madenler
- Tren sistemleri
- Sanayi tesisleri
- Etkinlik ve büyük organizasyonlar
- Endüstriyel fırın tesisleri
- Savunma sanayi

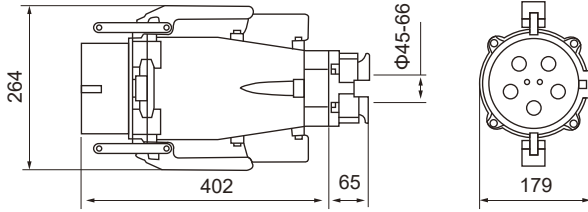

## Yüksek Amper

200A. - 250A - 350A. - 400A.

### Temel Karakteristikler:

**Yüksek akım kapasitesi:** 200A, 250A, 350A, 400A, seçenekleriyle geniş kullanım alanı.

**Yüksek gerilim dayanımı:** 380V-415V AC, 50/60 Hz uyumlu sistemler.

**Çoklu bağlantı seçenekleri:** 4 kontak (3P+E) ve 5 kontak (3P+N+E) konfigürasyonları.

**Pilot kontak desteği:** 2 adet pilot kontak ile ek güvenlik ve kontrol.

**IP 67 koruma sınıfı:** Zorlu çevre koşullarına karşı tam sızdırmazlık.

**Gümüş kaplama kontaklar:** Daha iyi iletkenlik ve uzun ömürlü bağlantılar.

**Kolay montaj ve demontaj:** Yardımcı kollar ile hızlı ve zahmetsiz kullanım.

**Değiştirilebilir kontak parçaları:** 250A ve 400A modeller için önden kolayca değiştirme imkânı.

**Gelişmiş güvenlik önlemleri:** Devre kesicili, elektrik kilitlemeli, mekanik kilitlemeli ve toprak kaçak koruma sistemleri.

**Standartlara tam uyum:** IEC EN 60309-1 / VDE 0623 ve IEC 60309-2 kodlama sistemleriyle tasarım.

| Gövde     | Nominal Akım (A) | Anma Akımı (A) | Çalışma Sıcaklığı | Kablo Kesiti (mm <sup>2</sup> ) |
|-----------|------------------|----------------|-------------------|---------------------------------|
| Plastik   | 200              | 200            | - 40 °C / +100 °C | 35 - 150                        |
| Plastik   | 250              | 250            | - 40 °C / +100 °C | 35 - 150                        |
| Alüminyum | 350              | 350            | - 40 °C / +100 °C | 70 - 240                        |
| Alüminyum | 400              | 400            | - 40 °C / +100 °C | 70 - 240                        |



**4x200A. (3P+E) 380V.**

| Ürün Kodu          | Açıklama                   | IP   | Kutu | Koli | Fiyat      |
|--------------------|----------------------------|------|------|------|------------|
| BC1-7504-7011      | 4/200A Düz Fiş             | IP67 | 1    | 0    | FİYAT ALIN |
| yeni BC1-7504-7022 | 4/200A Eğik Fiş            | IP67 | 1    | 0    | FİYAT ALIN |
| BC1-7504-7312      | 4/200A Uzatma Priz         | IP67 | 1    | 0    | FİYAT ALIN |
| BC1-7504-7413      | 4/200A Makine Priz         | IP67 | 1    | 0    | FİYAT ALIN |
| yeni BC1-7504-7114 | 4/200A Makine Fişi         | IP67 | 1    | 0    | FİYAT ALIN |
| BC1-7504-7540      | 4/200A 90° Eğik Duvar Priz | IP67 | 1    | 0    | FİYAT ALIN |

**5x200A. (3P+E+N) 380V.**

| Ürün Kodu          | Açıklama                   | IP   | Kutu | Koli | Fiyat      |
|--------------------|----------------------------|------|------|------|------------|
| BC1-7505-7011      | 5/200A Düz Fiş             | IP67 | 1    | 0    | FİYAT ALIN |
| yeni BC1-7505-7022 | 5/200A Eğik Fiş            | IP67 | 1    | 0    | FİYAT ALIN |
| BC1-7505-7312      | 5/200A Uzatma Priz         | IP67 | 1    | 0    | FİYAT ALIN |
| BC1-7505-7413      | 5/200A Makine Priz         | IP67 | 1    | 0    | FİYAT ALIN |
| yeni BC1-7505-7114 | 5/200A Makine Fişi         | IP67 | 1    | 0    | FİYAT ALIN |
| yeni BC1-7505-7540 | 5/200A 90° Eğik Duvar Priz | IP67 | 1    | 0    | FİYAT ALIN |

**250 Amper Seri****4x250A. (3P+E) 380V.**

| Ürün Kodu          | Açıklama                   | IP   | Kutu | Koli | Fiyat      |
|--------------------|----------------------------|------|------|------|------------|
| BC1-1014-7011      | 4/250A Düz Fiş             | IP67 | 1    | 0    | FİYAT ALIN |
| yeni BC1-1014-7022 | 4/250A Eğik Fiş            | IP67 | 1    | 0    | FİYAT ALIN |
| BC1-1014-7312      | 4/250A Uzatma priz         | IP67 | 1    | 0    | FİYAT ALIN |
| BC1-1014-7413      | 4/250A Makine Priz         | IP67 | 1    | 0    | FİYAT ALIN |
| yeni BC1-1014-7114 | 4/250A Makine Fişi         | IP67 | 1    | 0    | FİYAT ALIN |
| yeni BC1-1014-7540 | 4/250A 90° Eğik Duvar Priz | IP67 | 1    | 0    | FİYAT ALIN |

**5x250A. (3P+E+N) 380V.**

| Ürün Kodu          | Açıklama                   | IP   | Kutu | Koli | Fiyat      |
|--------------------|----------------------------|------|------|------|------------|
| BC1-1015-7011      | 5/250A Düz Fiş             | IP67 | 1    | 0    | FİYAT ALIN |
| yeni BC1-1015-7022 | 5/250A Eğik Fiş            | IP67 | 1    | 0    | FİYAT ALIN |
| BC1-1015-7312      | 5/250A Uzatma priz         | IP67 | 1    | 0    | FİYAT ALIN |
| BC1-1015-7413      | 5/250A Makine Priz         | IP67 | 1    | 0    | FİYAT ALIN |
| yeni BC1-1015-7114 | 5/250A Makine Fişi         | IP67 | 1    | 0    | FİYAT ALIN |
| yeni BC1-1015-7540 | 5/250A 90° Eğik Duvar Priz | IP67 | 1    | 0    | FİYAT ALIN |



**Not:** Fiyatları döviz olan ürünlerde vade ve indirim uygulanmamaktadır.  
Teknik detaylara [www.bemis.com.tr](http://www.bemis.com.tr) web sitemizden ulaşabilirsiniz.



## 350 Amper Seri

### 4x350A. (3P+E) 380V.

| Ürün Kodu     | Açıklama                   | IP   | Kutu | Koli | Fiyat      |
|---------------|----------------------------|------|------|------|------------|
| BC1-1114-7011 | 4/350A Düz Fiş             | IP67 | 1    | 0    | FİYAT ALIN |
| BC1-1114-7022 | 4/350A Eğik Fiş            | IP67 | 1    | 0    | FİYAT ALIN |
| BC1-1114-7312 | 4/350A Uzatma priz         | IP67 | 1    | 0    | FİYAT ALIN |
| BC1-1114-7413 | 4/350A Makine Priz         | IP67 | 1    | 0    | FİYAT ALIN |
| BC1-1114-7114 | 4/350A Makine Fişi         | IP67 | 1    | 0    | FİYAT ALIN |
| BC1-1114-7540 | 4/350A 90° Eğik Duvar Priz | IP67 | 1    | 0    | FİYAT ALIN |

### 5x350A. (3P+E+N) 380V.

| Ürün Kodu     | Açıklama                   | IP   | Kutu | Koli | Fiyat      |
|---------------|----------------------------|------|------|------|------------|
| BC1-1115-7011 | 5/350A Düz Fiş             | IP67 | 1    | 0    | FİYAT ALIN |
| BC1-1115-7022 | 5/350A Eğik Fiş            | IP67 | 1    | 0    | FİYAT ALIN |
| BC1-1115-7312 | 5/350A Uzatma priz         | IP67 | 1    | 0    | FİYAT ALIN |
| BC1-1115-7413 | 5/350A Makine Priz         | IP67 | 1    | 0    | FİYAT ALIN |
| BC1-1115-7114 | 5/350A Makine Fişi         | IP67 | 1    | 0    | FİYAT ALIN |
| BC1-1115-7540 | 5/350A 90° Eğik Duvar Priz | IP67 | 1    | 0    | FİYAT ALIN |

## 400 Amper Seri

### 4x400A. (3P+E) 380V.

| Ürün Kodu     | Açıklama                   | IP   | Kutu | Koli | Fiyat      |
|---------------|----------------------------|------|------|------|------------|
| BC1-9504-7011 | 4/400A Düz Fiş             | IP67 | 1    | 0    | FİYAT ALIN |
| BC1-9504-7022 | 4/400A Eğik Fiş            | IP67 | 1    | 0    | FİYAT ALIN |
| BC1-9504-7312 | 4/400A Uzatma Priz         | IP67 | 1    | 0    | FİYAT ALIN |
| BC1-9504-7413 | 4/400A Makine Priz         | IP67 | 1    | 0    | FİYAT ALIN |
| BC1-9504-7114 | 4/400A Makine Fişi         | IP67 | 1    | 0    | FİYAT ALIN |
| BC1-9504-7540 | 4/400A 90° Eğik Duvar Priz | IP67 | 1    | 0    | FİYAT ALIN |

### 5x400A. (3P+E+N) 380V.

| Ürün Kodu     | Açıklama                  | IP   | Kutu | Koli | Fiyat      |
|---------------|---------------------------|------|------|------|------------|
| BC1-9505-7011 | 5/400A Düz Fiş            | IP67 | 1    | 0    | FİYAT ALIN |
| BC1-9505-7022 | 5/400A Eğik Fiş           | IP67 | 1    | 0    | FİYAT ALIN |
| BC1-9505-7312 | 5/400A Uzatma Priz        | IP67 | 1    | 0    | FİYAT ALIN |
| BC1-9505-7413 | 5/400A Makine Priz        | IP67 | 1    | 0    | FİYAT ALIN |
| BC1-9505-7114 | 5/400A Makine Fişi        | IP67 | 1    | 0    | FİYAT ALIN |
| BC1-9505-7540 | 5/400A90° Eğik Duvar Priz | IP67 | 1    | 0    | FİYAT ALIN |



**Not:** Fiyatları döviz olan ürünlerde vade ve indirim uygulanmamaktadır.  
Teknik detaylara [www.bemis.com.tr](http://www.bemis.com.tr) web sitemizden ulaşabilirsiniz.



100  
yüzde  
yerli...

**B** bemis

## Aydınlatma

Trafo - El Lambası



Üreten Ülke Güçlüdür

| Ürün Kodu     | Açıklama   | IP   | Kutu | Koli | Fiyat       |
|---------------|--|------|------|------|-------------|
| BA1-1001-0001 | Seyyar El Lambası (Anahtarlı)                                | IP20 | 1    | 12   | 769,60 TL   |
| BA1-1001-1021 | Seyyar El Lambası (Anahtarlı 7,5mt Kablolu İzole Trafo İçin) | IP20 | 1    | 6    | 1.304,00 TL |
| BA1-1001-1031 | Seyyar El Lambası (Anahtarlı 7,5mt Kablolu)                  | IP20 | 1    | 6    | 1.095,00 TL |
| BA1-2001-0001 | Seyyar El Lambası (Anahtarsız)                               | IP20 | 1    | 12   | 713,70 TL   |
| BA1-2001-1031 | Seyyar El Lambası (Anahtarsız 7,5mt Kablolu)                 | IP20 | 1    | 6    | 1.032,00 TL |

| Ürün Kodu     | Açıklama                              | IP   | Kutu | Koli | Fiyat       |
|---------------|---------------------------------------|------|------|------|-------------|
| BA2-0110-0121 | 24V. Çıkışlı 100W. Trafo              | IP20 | 1    | 0    | 4.127,00 TL |
| BA2-0111-1121 | 24V. Çıkışlı 100W. Trafolu Aydınlatma | IP20 | 1    | 0    | 5.397,00 TL |
| BA2-0210-0121 | 24V. Çıkışlı 200W. Trafo              | IP20 | 1    | 0    | 5.397,00 TL |
| BA2-0211-1121 | 24V. Çıkışlı 200W. Trafolu Aydınlatma | IP20 | 1    | 0    | 6.666,00 TL |



Anahtarlı El Lambası  
BA1-1001-0001



Anahtarsız El Lambası  
BA1-2001-0001



Anahtarlı 7,5mt.  
Kablolu El Lambası  
BA1-1001-1031



Anahtarsız 7,5mt.  
Kablolu El Lambası  
BA1-2001-1031



Anahtarlı 7,5mt. 2x1mm  
Kablolu El Lambası  
24V. Fişli  
BA1-1001-1021



24V. 100W. Trafolu  
El Lambası  
BA2-0111-1121



24V. 100W. Trafo  
BA2-0110-0121



24V. 200W. Trafolu  
El Lambası  
BA2-0211-1121



24V. 200W. Trafo  
BA2-0210-0121



**B** bemis

**YENİ  
ÜRÜN**

# V20 KOMBİNASYON SERİSİ

IP44 - IP67



*Kalite saygının ifadesidir!..*





YENİ ÖZELLİK  
**KOMBİNASYONLARIMIZ ARTIK SU TERAZİLİ!**

Türkiye'de ilk olarak hayata geçirilen uygulama son kullanıcılar için daha düzenli bir montaj imkanı sağlamaktadır



TÜRKİYE'DE  
İLK



*Kalite saygının ifadesidir!..*



| Ürün Kodu     | Açıklama   | IP   | Kutu | Koli | Fiyat       |
|---------------|--|------|------|------|-------------|
| BD1-2000-0000 | V Otamat Raylı 1 Klemensli                             | IP44 | 1    | 12   | 380,00 TL   |
| BD1-2101-0000 | Delikli Boş Kombinasyon                                | IP44 | 1    | 12   | 380,00 TL   |
| BD1-2101-2020 | Ön 1 Ad.Delikli 1/16A 220V 2 Ad. Yan                   | IP44 | 1    | 12   | 594,00 TL   |
| BD1-2103-0000 | 1/16A. 220V. 1 Ad. M.P. Ön                             | IP44 | 1    | 12   | 507,00 TL   |
| BD1-2103-2020 | 1/16A. 220V. 1 Ad. M.P. Ön-1/16A. 220V. 2 Ad. Yan      | IP44 | 1    | 12   | 723,00 TL   |
| BD1-2105-0000 | 3/25A. 380V. 1 Ad. Ön                                  | IP44 | 1    | 12   | 547,00 TL   |
| BD1-2105-1020 | 3/25A. 380V. 1 Ad. Ön 1/16A. 220V. 1 Ad. Yan           | IP44 | 1    | 12   | 655,00 TL   |
| BD1-2105-2020 | 3/25A. 380V. 1 Ad. Ön 1/16A. 220V. 2 Ad. Yan           | IP44 | 1    | 12   | 763,00 TL   |
| BD1-2112-0000 | 4/16A. 380V. 1 Ad. Ön                                  | IP44 | 1    | 12   | 658,00 TL   |
| BD1-2112-2020 | 4/16A. 380V. 1 Ad. Ön. 1/16A. 220V. 2 Ad. Yan          | IP44 | 1    | 12   | 874,00 TL   |
| BD1-2118-0000 | 5/16A. 380V. 1 Ad. Ön                                  | IP44 | 1    | 12   | 730,00 TL   |
| BD1-2118-1020 | 5/16A. 380V. 1 Ad. Ön - 1/16A. 220V. 1 Ad. Yan         | IP44 | 1    | 12   | 838,00 TL   |
| BD1-2118-2020 | 5/16A. 380V. 1 Ad. Ön 1/16A. 220V. 2 Ad. Yan           | IP44 | 1    | 12   | 945,00 TL   |
| BD1-2123-2020 | 3/32A. 220V. 1 Ad. Ön - 1/16A. 220V. 2 Ad. Yan         | IP44 | 1    | 12   | 941,00 TL   |
| BD1-2128-0000 | 4/32A. 380V. 1 Ad. Ön                                  | IP44 | 1    | 12   | 765,00 TL   |
| BD1-2128-2020 | 4/32A. 380V. 1 Ad. Ön - 1/16A. 220V. 2 Ad. Yan         | IP44 | 1    | 12   | 981,00 TL   |
| BD1-2134-0000 | 5/32A. 380V. 1 Ad. Ön                                  | IP44 | 1    | 12   | 814,00 TL   |
| BD1-2134-1020 | 5/32A. 380V. 1 Ad. Ön - 1/16A. 220V. 1 Ad. Yan         | IP44 | 1    | 12   | 922,00 TL   |
| BD1-2134-2020 | 5/32A. 380V. 1 Ad. Ön 1/16A. 220V. 2 Ad. Yan           | IP44 | 1    | 12   | 1.030,00 TL |
| BD1-2202-0000 | 1/16A. 220V. 2 Ad. Ön Prizli                           | IP44 | 1    | 12   | 594,00 TL   |
| BD1-2202-2020 | 1/16A. 220V. 2 Ad. Ön 1/16A. 220V. 2 Ad. Yan           | IP44 | 1    | 12   | 810,00 TL   |
| BD1-6000-0000 | V Otamat Raylı 1 Klemensli                             | IP66 | 1    | 12   | 405,00 TL   |
| BD1-6114-0000 | 5/16A. 380V. 1 Ad. Ön                                  | IP66 | 1    | 12   | 872,00 TL   |
| BD1-6114-2020 | 5/16A. 380V. IP67 1 Ad. Ön 1/16A. 220V. IP68 2 Ad. Yan | IP66 | 1    | 12   | 1.334,00 TL |
| BD1-6124-0000 | 4/32A. 380V. 1 Ad. Ön                                  | IP66 | 1    | 12   | 920,00 TL   |
| BD1-6130-0000 | 5/32A. 380V. 1 Ad. Ön                                  | IP66 | 1    | 12   | 964,00 TL   |
| BD1-6130-2020 | 5/32A. 380V. IP67 1 Ad. Ön 1/16A. 220V. IP68 2 Ad. Yan | IP66 | 1    | 12   | 1.510,00 TL |



**Not:** Delikli kombinsayonlarımız, somunlu prizlerimize göre delinmektedir.



**5 SİGORTA KAPASİTELİ**

| Ürün Kodu     | Açıklama   | IP   | Kutu | Koli | Fiyat       |
|---------------|--|------|------|------|-------------|
| BH1-2000-0000 | V Otamat Raylı 1 Klemensli                             | IP44 | 1    | 12   | 472,00 TL   |
| BH1-2101-0000 | Delikli Boş Kombinasyon                                | IP44 | 1    | 12   | 472,00 TL   |
| BH1-2101-2020 | Ön 1 Ad.Delikli 1/16A 220V 2 Ad. Yan                   | IP44 | 1    | 12   | 688,00 TL   |
| BH1-2103-0000 | 1/16A. 220V. 1 Ad. M.P. Ön                             | IP44 | 1    | 12   | 601,00 TL   |
| BH1-2103-2020 | 1/16A. 220V. 1 Ad. M.P. Ön-1/16A. 220V. 2 Ad. Yan      | IP44 | 1    | 12   | 817,00 TL   |
| BH1-2105-0000 | 3/25A. 380V. 1 Ad. Ön                                  | IP44 | 1    | 12   | 641,00 TL   |
| BH1-2105-1020 | 3/25A. 380V. 1 Ad. Ön 1/16A. 220V. 1 Ad. Yan           | IP44 | 1    | 12   | 748,00 TL   |
| BH1-2105-2020 | 3/25A. 380V. 1 Ad. Ön 1/16A. 220V. 2 Ad. Yan           | IP44 | 1    | 12   | 856,00 TL   |
| BH1-2112-0000 | 4/16A. 380V. 1 Ad. Ön                                  | IP44 | 1    | 12   | 752,00 TL   |
| BH1-2112-2020 | 4/16A. 380V. 1 Ad. Ön. 1/16A. 220V. 2 Ad. Yan          | IP44 | 1    | 12   | 968,00 TL   |
| BH1-2118-0000 | 5/16A. 380V. 1 Ad. Ön                                  | IP44 | 1    | 12   | 823,00 TL   |
| BH1-2118-1020 | 5/16A. 380V. 1 Ad. Ön - 1/16A. 220V. 1 Ad. Yan         | IP44 | 1    | 12   | 931,00 TL   |
| BH1-2118-2020 | 5/16A. 380V. 1 Ad. Ön 1/16A. 220V. 2 Ad. Yan           | IP44 | 1    | 12   | 1.039,00 TL |
| BH1-2123-2020 | 3/32A. 220V. 1 Ad. Ön - 1/16A. 220V. 2 Ad. Yan         | IP44 | 1    | 12   | 1.035,00 TL |
| BH1-2128-0000 | 4/32A. 380V. 1 Ad. Ön                                  | IP44 | 1    | 12   | 859,00 TL   |
| BH1-2128-2020 | 4/32A. 380V. 1 Ad. Ön - 1/16A. 220V. 2 Ad. Yan         | IP44 | 1    | 12   | 1.075,00 TL |
| BH1-2134-0000 | 5/32A. 380V. 1 Ad. Ön                                  | IP44 | 1    | 12   | 908,00 TL   |
| BH1-2134-1020 | 5/32A. 380V. 1 Ad. Ön - 1/16A. 220V. 1 Ad. Yan         | IP44 | 1    | 12   | 1.016,00 TL |
| BH1-2134-2020 | 5/32A. 380V. 1 Ad. Ön 1/16A. 220V. 2 Ad. Yan           | IP44 | 1    | 12   | 1.124,00 TL |
| BH1-2202-0000 | 1/16A. 220V. 2 Ad. Ön Prizli                           | IP44 | 1    | 12   | 688,00 TL   |
| BH1-2202-2020 | 1/16A. 220V. 2 Ad. Ön 1/16A. 220V. 2 Ad. Yan           | IP44 | 1    | 12   | 904,00 TL   |
| BH1-6000-0000 | V Otamat Raylı 1 Klemensli                             | IP66 | 1    | 12   | 524,00 TL   |
| BH1-6114-0000 | 5/16A. 380V. 1 Ad. Ön                                  | IP66 | 1    | 12   | 1.015,00 TL |
| BH1-6114-2020 | 5/16A. 380V. IP67 1 Ad. Ön 1/16A. 220V. IP68 2 Ad. Yan | IP66 | 1    | 12   | 1.609,00 TL |
| BH1-6124-0000 | 4/32A. 380V. 1 Ad. Ön                                  | IP66 | 1    | 12   | 1.062,00 TL |
| BH1-6130-0000 | 5/32A. 380V. 1 Ad. Ön                                  | IP66 | 1    | 12   | 1.107,00 TL |
| BH1-6130-2020 | 5/32A. 380V. IP67 1 Ad. Ön 1/16A. 220V. IP68 2 Ad. Yan | IP66 | 1    | 12   | 1.817,00 TL |

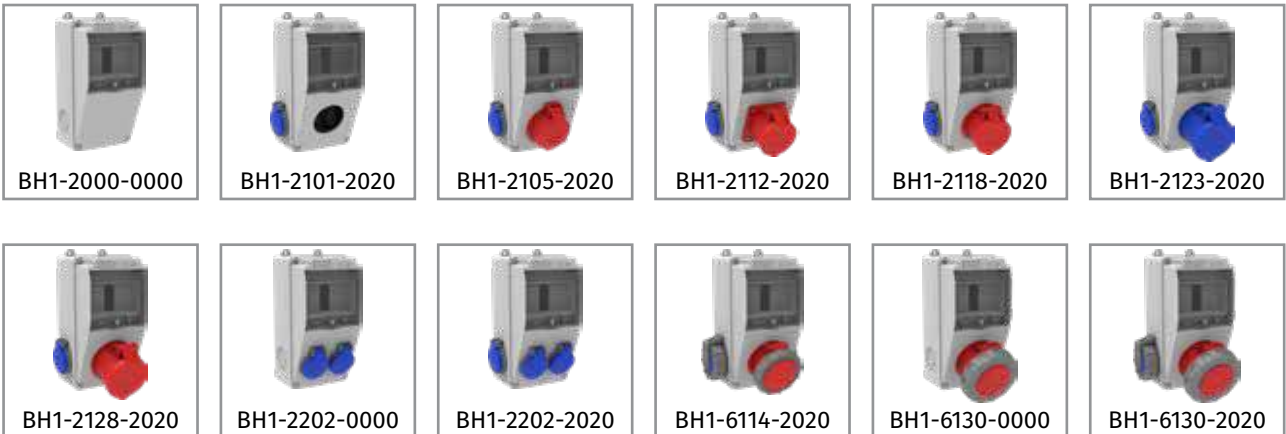

**Not:** Delikli kombinasyonlarımız, somunlu prizlerimize göre delinmektedir.

| Ürün Kodu     | Açıklama  | IP   | Kutu | Koli | Fiyat       |
|---------------|---|------|------|------|-------------|
| BD5-2000-0000 | V Otamat Raylı 1 Klemensli Kombinasyon                                  | IP44 | 1    | 12   | 482,00 TL   |
| BD5-2101-0000 | Ön Delikli Boş Kombinasyon  | IP44 | 1    | 12   | 482,00 TL   |
| BD5-2101-2020 | Ön 1 Ad. Delikli - Yan 2 Ad. 1/16A. 220V.                               | IP44 | 1    | 12   | 698,00 TL   |
| BD5-2103-0000 | 1/16A. 220V. 1 Ad. M.P. Ön  | IP44 | 1    | 12   | 611,00 TL   |
| BD5-2103-2020 | 1/16A. 220V. 1 Ad. M.P. Ön - 1/16A. 220V. 2 Ad. Yan                     | IP44 | 1    | 12   | 827,00 TL   |
| BD5-2105-0000 | 3/25A. 380V. 1 Ad. Ön   | IP44 | 1    | 12   | 650,00 TL   |
| BD5-2105-2020 | Ön 1 Ad. 3/25A. 380V. Yan 2 Ad. 1/16A. 220V.                            | IP44 | 1    | 12   | 866,00 TL   |
| BD5-2105-4020 | 3/25A. 380V. 1 Ad. Ön - 1/16A. 220V. 2 Ad. Yan - 1/16A. 220V. 2 Ad. Alt | IP44 | 1    | 12   | 1.082,00 TL |
| BD5-2112-0000 | 4/16A. 380V. 1 Ad. Ön   | IP44 | 1    | 12   | 762,00 TL   |
| BD5-2112-2020 | 4/16A. 380V. 1 Ad. Ön - 1/16A. 220V. 2 Ad. Yan                          | IP44 | 1    | 12   | 978,00 TL   |
| BD5-2112-4020 | 4/16A. 380V. 1 Ad. Ön - 1/16A. 220V. 2 Ad. Yan - 1/16A. 220V. 2 Ad. Alt | IP44 | 1    | 12   | 1.194,00 TL |
| BD5-2118-0000 | 5/16A. 380V. 1 Ad. Ön   | IP44 | 1    | 12   | 833,00 TL   |
| BD5-2118-2020 | Ön 1 Ad. 5/16A. 380V. Yan 2 Ad. 1/16A. 220V.                            | IP44 | 1    | 12   | 1.049,00 TL |
| BD5-2118-4020 | 5/16A. 380V. 1 Ad. Ön - 1/16A. 220V. 2 Ad. Yan - 1/16A. 220V. 2 Ad. Alt | IP44 | 1    | 12   | 1.265,00 TL |
| BD5-2123-2020 | 3/32A. 220V. 1 Ad. Ön - 1/16A. 220V. 2 Ad. Yan                          | IP44 | 1    | 12   | 1.045,00 TL |
| BD5-2128-0000 | 4/32A. 380V. 1 Ad. Ön   | IP44 | 1    | 12   | 869,00 TL   |
| BD5-2128-2020 | 4/32A. 380V. 1 Ad. Ön - 1/16A. 220V. 2 Ad. Yan                          | IP44 | 1    | 12   | 1.085,00 TL |
| BD5-2128-4020 | 4/32A. 380V. 1 Ad. Ön - 1/16A. 220V. 2 Ad. Yan - 1/16A. 220V. 2 Ad. Alt | IP44 | 1    | 12   | 1.301,00 TL |
| BD5-2134-0000 | 5/32A. 380V. 1 Ad. Ön   | IP44 | 1    | 12   | 918,00 TL   |
| BD5-2134-2020 | Ön 1 Ad. 5/32A. 380V. Yan 2 Ad. 1/16A. 220V.                            | IP44 | 1    | 12   | 1.134,00 TL |
| BD5-2134-4020 | 5/32A. 380V. 1 Ad. Ön - 1/16A. 220V. 2 Ad. Yan - 1/16A. 220V. 2 Ad. Alt | IP44 | 1    | 12   | 1.350,00 TL |
| BD5-2144-2020 | 4/63A. 380V. 1 Ad. Ön - 1/16A. 220V. 2 Ad. Yan                          | IP44 | 1    | 12   | 1.889,00 TL |
| BD5-2202-0000 | 1/16A. 220V. 2 Ad. Ön   | IP44 | 1    | 12   | 698,00 TL   |
| BD5-2202-2020 | 1/16A. 220V. 2 Ad. Ön - 1/16A. 220V. 2 Ad. Yan                          | IP44 | 1    | 12   | 914,00 TL   |
| BD5-6000-0000 | V Otamat Raylı 1 Klemensli Kombinasyon                                  | IP66 | 1    | 12   | 534,00 TL   |
| BD5-6102-2020 | 1/16A. 220V. 1 Ad. Ön - 1/16A. 220V. 2 Ad. Yan                          | IP66 | 1    | 12   | 1.871,00 TL |
| BD5-6114-0000 | 5/16A. 380V. 1 Ad. Ön   | IP66 | 1    | 12   | 1.026,00 TL |
| BD5-6114-2020 | Ön 1 Ad. 5/16A. 380V. Yan 2 Ad. 1/16A. 220V.                            | IP66 | 1    | 12   | 1.916,00 TL |
| BD5-6124-0000 | 4/32A. 380V. 1 Ad. Ön   | IP66 | 1    | 12   | 1.073,00 TL |
| BD5-6124-2020 | 4/32A. 380V. 1 Ad. Ön - 1/16A. 220V. 2 Ad. Yan                          | IP66 | 1    | 12   | 1.964,00 TL |
| BD5-6130-0000 | 5/32A. 380V. 1 Ad. Ön   | IP66 | 1    | 12   | 1.117,00 TL |
| BD5-6130-2020 | Ön 1 Ad. 5/32A. 380V. Yan 2 Ad. 1/16A. 220V.                            | IP66 | 1    | 12   | 2.008,00 TL |
| BD5-6140-2020 | 4/63A. 380V. 1 Ad. Ön - 1/16A. 220V. 2 Ad. Yan                          | IP66 | 1    | 12   | 2.828,00 TL |



**7 SİGORTA KAPASİTELİ**

| Ürün Kodu     | Açıklama  | IP   | Kutu | Koli | Fiyat       |
|---------------|---|------|------|------|-------------|
| BH5-2000-0000 | V Otamat Raylı 1 Klemensli Kombinasyon                                  | IP44 | 1    | 12   | 520,00 TL   |
| BH5-2101-0000 | Ön Delikli Boş Kombinasyon  | IP44 | 1    | 12   | 520,00 TL   |
| BH5-2101-2020 | Ön 1 Ad. Delikli - Yan 2 Ad. 1/16A. 220V.                               | IP44 | 1    | 12   | 736,00 TL   |
| BH5-2103-0000 | 1/16A. 220V. 1 Ad. M.P. Ön  | IP44 | 1    | 12   | 649,00 TL   |
| BH5-2103-2020 | 1/16A. 220V. 1 Ad. M.P. Ön - 1/16A. 220V. 2 Ad. Yan                     | IP44 | 1    | 12   | 865,00 TL   |
| BH5-2105-0000 | 3/25A. 380V. 1 Ad. Ön   | IP44 | 1    | 12   | 688,00 TL   |
| BH5-2105-2020 | Ön 1 Ad. 3/25A. 380V. Yan 2 Ad. 1/16A. 220V.                            | IP44 | 1    | 12   | 904,00 TL   |
| BH5-2105-4020 | 3/25A. 380V. 1 Ad. Ön - 1/16A. 220V. 2 Ad. Yan - 1/16A. 220V. 2 Ad. Alt | IP44 | 1    | 12   | 1.120,00 TL |
| BH5-2112-0000 | 4/16A. 380V. 1 Ad. Ön   | IP44 | 1    | 12   | 800,00 TL   |
| BH5-2112-2020 | 4/16A. 380V. 1 Ad. Ön - 1/16A. 220V. 2 Ad. Yan                          | IP44 | 1    | 12   | 1.016,00 TL |
| BH5-2112-4020 | 4/16A. 380V. 1 Ad. Ön - 1/16A. 220V. 2 Ad. Yan - 1/16A. 220V. 2 Ad. Alt | IP44 | 1    | 12   | 1.232,00 TL |
| BH5-2118-0000 | 5/16A. 380V. 1 Ad. Ön   | IP44 | 1    | 12   | 871,00 TL   |
| BH5-2118-2020 | Ön 1 Ad. 5/16A. 380V. Yan 2 Ad. 1/16A. 220V.                            | IP44 | 1    | 12   | 1.087,00 TL |
| BH5-2118-4020 | 5/16A. 380V. 1 Ad. Ön - 1/16A. 220V. 2 Ad. Yan - 1/16A. 220V. 2 Ad. Alt | IP44 | 1    | 12   | 1.303,00 TL |
| BH5-2123-2020 | 3/32A. 220V. 1 Ad. Ön - 1/16A. 220V. 2 Ad. Yan                          | IP44 | 1    | 12   | 1.083,00 TL |
| BH5-2128-0000 | 4/32A. 380V. 1 Ad. Ön   | IP44 | 1    | 12   | 907,00 TL   |
| BH5-2128-2020 | 4/32A. 380V. 1 Ad. Ön - 1/16A. 220V. 2 Ad. Yan                          | IP44 | 1    | 12   | 1.123,00 TL |
| BH5-2128-4020 | 4/32A. 380V. 1 Ad. Ön - 1/16A. 220V. 2 Ad. Yan - 1/16A. 220V. 2 Ad. Alt | IP44 | 1    | 12   | 1.339,00 TL |
| BH5-2134-0000 | 5/32A. 380V. 1 Ad. Ön   | IP44 | 1    | 12   | 956,00 TL   |
| BH5-2134-2020 | Ön 1 Ad. 5/32A. 380V. Yan 2 Ad. 1/16A. 220V.                            | IP44 | 1    | 12   | 1.172,00 TL |
| BH5-2134-4020 | 5/32A. 380V. 1 Ad. Ön - 1/16A. 220V. 2 Ad. Yan - 1/16A. 220V. 2 Ad. Alt | IP44 | 1    | 12   | 1.388,00 TL |
| BH5-2144-2020 | 4/63A. 380V. 1 Ad. Ön - 1/16A. 220V. 2 Ad. Yan                          | IP44 | 1    | 12   | 1.927,00 TL |
| BH5-2202-0000 | 1/16A. 220V. 2 Ad. Ön   | IP44 | 1    | 12   | 736,00 TL   |
| BH5-2202-2020 | 1/16A. 220V. 2 Ad. Ön - 1/16A. 220V. 2 Ad. Yan                          | IP44 | 1    | 12   | 952,00 TL   |
| BH5-6000-0000 | V Otamat Raylı 1 Klemensli Kombinasyon                                  | IP66 | 1    | 12   | 572,00 TL   |
| BH5-6102-2020 | 1/16A. 220V. 1 Ad. Ön - 1/16A. 220V. 2 Ad. Yan                          | IP66 | 1    | 12   | 1.909,00 TL |
| BH5-6114-0000 | 5/16A. 380V. 1 Ad. Ön   | IP66 | 1    | 12   | 1.063,00 TL |
| BH5-6114-2020 | Ön 1 Ad. 5/16A. 380V. Yan 2 Ad. 1/16A. 220V.                            | IP66 | 1    | 12   | 1.954,00 TL |
| BH5-6124-0000 | 4/32A. 380V. 1 Ad. Ön   | IP66 | 1    | 12   | 1.111,00 TL |
| BH5-6124-2020 | 4/32A. 380V. 1 Ad. Ön - 1/16A. 220V. 2 Ad. Yan                          | IP66 | 1    | 12   | 2.002,00 TL |
| BH5-6130-0000 | 5/32A. 380V. 1 Ad. Ön   | IP66 | 1    | 12   | 1.155,00 TL |
| BH5-6130-2020 | Ön 1 Ad. 5/32A. 380V. Yan 2 Ad. 1/16A. 220V.                            | IP66 | 1    | 12   | 2.046,00 TL |
| BH5-6140-2020 | 4/63A. 380V. 1 Ad. Ön - 1/16A. 220V. 2 Ad. Yan                          | IP66 | 1    | 12   | 2.866,00 TL |



| Ürün Kodu     | Açıklama   | IP   | Kutu | Koli | Fiyat       |
|---------------|--|------|------|------|-------------|
| BD2-2000-0000 | V Otamat Raylı 2 Klemensli Kombinasyon                                 | IP44 | 1    | 6    | 680,00 TL   |
| BD2-2118-2020 | 5/16A. 380V. 1 Ad. Ön - 1/16A. 220V. 2 Ad. Ön                          | IP44 | 1    | 6    | 1.247,00 TL |
| BD2-2118-2022 | 5/16A. 380V. 1 Ad. Ön - 1/16A. 220V. 2 Ad. Ön - 1/16A. 220V. 2 Ad. Yan | IP44 | 1    | 6    | 1.463,00 TL |
| BD2-2134-1030 | 5/32A. 380V. 1 Ad. Ön - 1/16A. 220V. 1 Ad. M.P. Ön                     | IP44 | 1    | 6    | 1.245,00 TL |
| BD2-2134-1182 | 5/32A. 380V. 1 Ad. Ön - 5/16A. 380V. 1 Ad. Ön - 1/16A. 220V. 2 Ad. Yan | IP44 | 1    | 6    | 1.683,00 TL |
| BD2-2134-1282 | 5/32A. 380V. 1 Ad. Ön - 4/32A. 380V. 1 Ad. Ön - 1/16A. 220V. 2 Ad. Yan | IP44 | 1    | 6    | 1.719,00 TL |
| BD2-2134-2020 | 5/32A. 380V. 1 Ad. Ön - 1/16A. 220V. 2 Ad. Ön                          | IP44 | 1    | 6    | 1.332,00 TL |
| BD2-2149-2020 | 5/63A. 380V. 1 Ad. Ön - 1/16A. 220V. 2 Ad. Ön                          | IP44 | 1    | 6    | 2.432,00 TL |
| BD2-2201-0000 | Ön 2 Ad. Delikli Boş Kombinasyon                                       | IP44 | 1    | 6    | 680,00 TL   |
| BD2-2201-2010 | Ön 2 Ad. Delikli Yan 2 Ad. Delikli Kombinasyon                         | IP44 | 1    | 6    | 680,00 TL   |
| BD2-2201-2020 | Ön 2 Ad. Delikli Yan 2 Ad. 1/16A. 220V.                                | IP44 | 1    | 6    | 896,00 TL   |
| BD2-2205-0000 | 3/25A. 380V. 2 Ad. Ön  | IP44 | 1    | 6    | 1.017,00 TL |
| BD2-2205-2020 | Ön 2 Ad. 3/25A. 380V. Yan 2 Ad. 1/16A. 220V.                           | IP44 | 1    | 6    | 1.233,00 TL |
| BD2-2205-4020 | 3/25A. 380V. 2 Ad. Ön - 1/16A. 220V. 4 Ad. Yan                         | IP44 | 1    | 6    | 1.448,00 TL |
| BD2-2212-2020 | 4/16A. 380V. 2 Ad. Ön - 1/16A. 220V. 2 Ad. Yan                         | IP44 | 1    | 6    | 1.456,00 TL |
| BD2-2218-0000 | 5/16A. 380V. 2 Ad. Yan   | IP44 | 1    | 6    | 1.382,00 TL |
| BD2-2218-2020 | Ön 2 Ad. 5/16A. 380V. Yan 2 Ad. 1/16A. 220V.                           | IP44 | 1    | 6    | 1.598,00 TL |
| BD2-2218-4020 | 5/16A. 380V. 2 Ad. Ön - 1/16A. 220V. 4 Ad. Yan                         | IP44 | 1    | 6    | 1.814,00 TL |
| BD2-2228-0000 | 4/32A. 380V. 2 Ad. Ön  | IP44 | 1    | 6    | 1.454,00 TL |
| BD2-2228-2020 | Ön 2 Ad. 4/32A. 380V. Yan 2 Ad. 1/16A. 220V.                           | IP44 | 1    | 6    | 1.670,00 TL |
| BD2-2234-0000 | 5/32A. 380V. 2 Ad. Ön  | IP44 | 1    | 6    | 1.552,00 TL |
| BD2-2234-2020 | Ön 2 Ad. 5/32A. 380V. Yan 2 Ad. 1/16A. 220V.                           | IP44 | 1    | 6    | 1.768,00 TL |
| BD2-2234-4020 | 5/32A. 380V. 2 Ad. Ön - 1/16A. 220V. 4 Ad. Yan                         | IP44 | 1    | 6    | 1.984,00 TL |
| BD2-2402-0000 | 1/16A. 220V. 4 Ad. P.P. Ön   | IP44 | 1    | 6    | 1.112,00 TL |
| BD2-2602-0000 | 1/16A. 220V. 6 Ad. P.P. Ön   | IP44 | 1    | 6    | 1.328,00 TL |
| BD2-6000-0000 | V Otamat Raylı 2 Klemensli Kombinasyon                                 | IP66 | 1    | 6    | 715,00 TL   |
| BD2-6129-2020 | 5/32A. 45° Eğik M.P 1 Ad. Ön. 1/16A IP68 2 Ad. Yan                     | IP66 | 1    | 6    | 1.919,00 TL |
| BD2-6130-1142 | 5/32A. 380V. 1 Ad. Ön 5/16A. 380V. 1 Ad. Ön 1/16A. 220V. 2 Ad. Yan     | IP66 | 1    | 6    | 2.326,00 TL |
| BD2-6130-2020 | 5/32A. 380V. 1 Ad. Ön 1/16A. 220V. 2 Ad. Yan                           | IP66 | 1    | 6    | 1.931,00 TL |
| BD2-6208-0000 | 4/16A. 380V. 2 Ad. Ön  | IP66 | 1    | 6    | 1.637,00 TL |
| BD2-6214-2020 | 5/16A. 380V. IP67 2 Ad. Ön 1/16A. 220V. IP68 2 Ad. Yan                 | IP66 | 1    | 6    | 2.185,00 TL |
| BD2-6224-0000 | 4/32A. 380V. 2 Ad. Ön  | IP66 | 1    | 6    | 1.792,00 TL |
| BD2-6230-0000 | 5/32A. 380V. 2 Ad. Ön  | IP66 | 1    | 6    | 1.881,00 TL |
| BD2-6230-2020 | 5/32A. 380V. 2 Ad. Ön 1/16A. 220V. IP68 2 Ad. Yan                      | IP66 | 1    | 6    | 2.465,00 TL |



**10 SİGORTA KAPASİTELİ**

| Ürün Kodu     | Açıklama   | IP   | Kutu | Koli | Fiyat       |
|---------------|--|------|------|------|-------------|
| BH2-2000-0000 | V Otamat Raylı 2 Klemensli Kombinasyon                                 | IP44 | 1    | 6    | 866,00 TL   |
| BH2-2118-2020 | 5/16A. 380V. 1 Ad. Ön - 1/16A. 220V. 2 Ad. Ön                          | IP44 | 1    | 6    | 1.432,00 TL |
| BH2-2118-2022 | 5/16A. 380V. 1 Ad. Ön - 1/16A. 220V. 2 Ad. Ön - 1/16A. 220V. 2 Ad. Yan | IP44 | 1    | 6    | 1.648,00 TL |
| BH2-2134-1030 | 5/32A. 380V. 1 Ad. Ön - 1/16A. 220V. 1 Ad. M.P. Ön                     | IP44 | 1    | 6    | 1.430,00 TL |
| BH2-2134-1182 | 5/32A. 380V. 1 Ad. Ön - 5/16A. 380V. 1 Ad. Ön - 1/16A. 220V. 2 Ad. Yan | IP44 | 1    | 6    | 1.868,00 TL |
| BH2-2134-1282 | 5/32A. 380V. 1 Ad. Ön - 4/32A. 380V. 1 Ad. Ön - 1/16A. 220V. 2 Ad. Yan | IP44 | 1    | 6    | 1.904,00 TL |
| BH2-2134-2020 | 5/32A. 380V. 1 Ad. Ön - 1/16A. 220V. 2 Ad. Ön                          | IP44 | 1    | 6    | 1.517,00 TL |
| BH2-2149-2020 | 5/63A. 380V. 1 Ad. Ön - 1/16A. 220V. 2 Ad. Ön                          | IP44 | 1    | 6    | 2.617,00 TL |
| BH2-2201-0000 | Ön 2 Ad. Delikli Boş Kombinasyon                                       | IP44 | 1    | 6    | 866,00 TL   |
| BH2-2201-2010 | Ön 2 Ad. Delikli Yan 2 Ad. Delikli Kombinasyon                         | IP44 | 1    | 6    | 866,00 TL   |
| BH2-2201-2020 | Ön 2 Ad. Delikli Yan 2 Ad. 1/16A. 220V.                                | IP44 | 1    | 6    | 1.081,00 TL |
| BH2-2205-0000 | 3/25A. 380V. 2 Ad. Ön  | IP44 | 1    | 6    | 1.202,00 TL |
| BH2-2205-2020 | Ön 2 Ad. 3/25A. 380V. Yan 2 Ad. 1/16A. 220V.                           | IP44 | 1    | 6    | 1.418,00 TL |
| BH2-2205-4020 | 3/25A. 380V. 2 Ad. Ön - 1/16A. 220V. 4 Ad. Yan                         | IP44 | 1    | 6    | 1.634,00 TL |
| BH2-2212-2020 | 4/16A. 380V. 2 Ad. Ön - 1/16A. 220V. 2 Ad. Yan                         | IP44 | 1    | 6    | 1.641,00 TL |
| BH2-2218-0000 | 5/16A. 380V. 2 Ad. Yan   | IP44 | 1    | 6    | 1.568,00 TL |
| BH2-2218-2020 | Ön 2 Ad. 5/16A. 380V. Yan 2 Ad. 1/16A. 220V.                           | IP44 | 1    | 6    | 1.784,00 TL |
| BH2-2218-4020 | 5/16A. 380V. 2 Ad. Ön - 1/16A. 220V. 4 Ad. Yan                         | IP44 | 1    | 6    | 1.999,00 TL |
| BH2-2228-0000 | 4/32A. 380V. 2 Ad. Ön  | IP44 | 1    | 6    | 1.639,00 TL |
| BH2-2228-2020 | Ön 2 Ad. 4/32A. 380V. Yan 2 Ad. 1/16A. 220V.                           | IP44 | 1    | 6    | 1.855,00 TL |
| BH2-2234-0000 | 5/32A. 380V. 2 Ad. Ön  | IP44 | 1    | 6    | 1.737,00 TL |
| BH2-2234-2020 | Ön 2 Ad. 5/32A. 380V. Yan 2 Ad. 1/16A. 220V.                           | IP44 | 1    | 6    | 1.953,00 TL |
| BH2-2234-4020 | 5/32A. 380V. 2 Ad. Ön - 1/16A. 220V. 4 Ad. Yan                         | IP44 | 1    | 6    | 2.169,00 TL |
| BH2-2402-0000 | 1/16A. 220V. 4 Ad. P.P. Ön   | IP44 | 1    | 6    | 1.297,00 TL |
| BH2-2602-0000 | 1/16A. 220V. 6 Ad. P.P. Ön   | IP44 | 1    | 6    | 1.513,00 TL |
| BH2-6000-0000 | V Otamat Raylı 2 Klemensli Kombinasyon                                 | IP66 | 1    | 6    | 971,00 TL   |
| BH2-6129-2020 | 5/32A. 45° Eğik M.P 1 Ad. Ön. 1/16A IP68 2 Ad. Yan                     | IP66 | 1    | 6    | 1.993,00 TL |
| BH2-6130-1142 | 5/32A. 380V. 1 Ad. Ön 5/16A. 380V. 1 Ad. Ön 1/16A. 220V. 2 Ad. Yan     | IP66 | 1    | 6    | 2.453,00 TL |
| BH2-6130-2020 | 5/32A. 380V. 1 Ad. Ön 1/16A. 220V. 2 Ad. Yan                           | IP66 | 1    | 6    | 2.019,00 TL |
| BH2-6208-0000 | 4/16A. 380V. 2 Ad. Ön  | IP66 | 1    | 6    | 1.893,00 TL |
| BH2-6214-2020 | 5/16A. 380V. IP67 2 Ad. Ön 1/16A. 220V. IP68 2 Ad. Yan                 | IP66 | 1    | 6    | 2.250,00 TL |
| BH2-6224-0000 | 4/32A. 380V. 2 Ad. Ön  | IP66 | 1    | 6    | 2.048,00 TL |
| BH2-6230-0000 | 5/32A. 380V. 2 Ad. Ön  | IP66 | 1    | 6    | 2.137,00 TL |
| BH2-6230-2020 | 5/32A. 380V. 2 Ad. Ön 1/16A. 220V. IP68 2 Ad. Yan                      | IP66 | 1    | 6    | 2.590,00 TL |



| Ürün Kodu     | Açıklama   | IP   | Kutu | Koli | Fiyat       |
|---------------|--|------|------|------|-------------|
| BD6-2000-0000 | V Otamat Raylı 2 Klemensli Kombinasyon                                 | IP44 | 1    | 6    | 815,00 TL   |
| BD6-2118-2020 | 5/16A. 380V. 1 Ad. Ön - 1/16A. 220V. 2 Ad. Ön                          | IP44 | 1    | 6    | 1.382,00 TL |
| BD6-2118-2022 | 5/16A. 380V. 1 Ad. Ön - 1/16A. 220V. 2 Ad. Ön - 1/16A. 220V. 2 Ad. Yan | IP44 | 1    | 6    | 1.598,00 TL |
| BD6-2134-1182 | 5/32A. 380V. 1 Ad. Ön - 5/16A. 380V. 1 Ad. Ön - 1/16A. 220V. 2 Ad. Yan | IP44 | 1    | 6    | 1.818,00 TL |
| BD6-2134-1282 | 5/32A. 380V. 1 Ad. Ön - 4/32A. 380V. 1 Ad. Ön - 1/16A. 220V. 2 Ad. Yan | IP44 | 1    | 6    | 1.854,00 TL |
| BD6-2134-2020 | 5/32A. 380V. 1 Ad. Ön - 1/16A. 220V. 2 Ad. Ön                          | IP44 | 1    | 6    | 1.467,00 TL |
| BD6-2149-2020 | 5/63A. 380V. 1 Ad. Ön - 1/16A. 220V. 2 Ad. Ön                          | IP44 | 1    | 6    | 2.566,00 TL |
| BD6-2201-0000 | Ön 2 Ad. Delikli Boş Kombinasyon                                       | IP44 | 1    | 6    | 815,00 TL   |
| BD6-2201-2010 | Ön 2 Ad. Delikli Yan 2 Ad. Delikli Boş Kombinasyon                     | IP44 | 1    | 6    | 815,00 TL   |
| BD6-2201-2020 | Ön 2 Ad. Delikli 2 Ad. Yan 1/16A. 220V. Kombinasyon                    | IP44 | 1    | 6    | 1.031,00 TL |
| BD6-2205-0000 | 3/25A. 380V. 2 Ad. Ön  | IP44 | 1    | 6    | 1.152,00 TL |
| BD6-2205-2020 | Ön 2 Ad. 3/25A. 380V. Yan 2 Ad. 1/16A. 220V.                           | IP44 | 1    | 6    | 1.368,00 TL |
| BD6-2205-4020 | 3/25A. 380V. 2 Ad. Ön - 1/16A. 220V. 4 Ad. Yan                         | IP44 | 1    | 6    | 1.583,00 TL |
| BD6-2212-2020 | 4/16A. 380V. 2 Ad. Ön - 1/16A. 220V. 2 Ad. Yan                         | IP44 | 1    | 6    | 1.591,00 TL |
| BD6-2218-0000 | 5/16A. 380V. 2 Ad. Yan   | IP44 | 1    | 6    | 1.517,00 TL |
| BD6-2218-2020 | Ön 2 Ad. 5/16A. 380V. Yan 2Ad. 1/16A. 220V.                            | IP44 | 1    | 6    | 1.733,00 TL |
| BD6-2228-0000 | 4/32A. 380V. 2 Ad. Ön  | IP44 | 1    | 6    | 1.589,00 TL |
| BD6-2228-2020 | 4/32A. 380V. 2 Ad. Ön - 1/16A. 220V. 2 Ad. Yan                         | IP44 | 1    | 6    | 1.805,00 TL |
| BD6-2234-0000 | 5/32A. 380V. 2 Ad. Ön  | IP44 | 1    | 6    | 1.687,00 TL |
| BD6-2234-2020 | Ön 2 Ad. 5/32A. 380V. Yan 2 Ad. 1/16A. 220V.                           | IP44 | 1    | 6    | 1.903,00 TL |
| BD6-2234-4020 | 5/32A. 380V. 2 Ad. Ön - 1/16A. 220V. 4 Ad. Yan                         | IP44 | 1    | 6    | 2.119,00 TL |
| BD6-2249-2020 | 5/63A. 380V. 2 Ad. Ön - 1/16A. 220V. 2 Ad. Yan                         | IP44 | 1    | 6    | 4.102,00 TL |
| BD6-2802-4020 | 1/16A. 220V. 8 Ad. P.P. Ön - 1/16A. 220V. 4 Ad. P.P. Yan               | IP44 | 1    | 6    | 2.110,00 TL |
| BD6-6000-0000 | V Otamat Raylı 2 Klemensli Kombinasyon                                 | IP66 | 1    | 6    | 900,00 TL   |
| BD6-6208-0000 | 4/16A. 380V. 2 Ad. Ön  | IP66 | 1    | 6    | 1.822,00 TL |
| BD6-6208-2020 | 4/16A. 380V. 2 Ad. Ön - 1/16A. 220V. 2 Ad. Yan                         | IP66 | 1    | 6    | 2.713,00 TL |
| BD6-6214-2020 | 5/16A. 380V. 2 Ad. Ön - 1/16A. 220V. 2 Ad. Yan                         | IP66 | 1    | 6    | 2.773,00 TL |
| BD6-6224-0000 | 4/32A. 380V. 2 Ad. Ön  | IP66 | 1    | 6    | 1.977,00 TL |
| BD6-6224-2020 | 4/32A. 380V. 2 Ad. Ön - 1/16A. 220V. 2 Ad. Yan                         | IP66 | 1    | 6    | 2.868,00 TL |
| BD6-6230-0000 | 5/32A. 380V. 2 Ad. Ön  | IP66 | 1    | 6    | 2.066,00 TL |
| BD6-6230-2020 | Ön 2 Ad. 5/32A. 380V. Yan 2 Ad. 1/16A. 220V. Som. Priz                 | IP66 | 1    | 6    | 2.957,00 TL |
| BD6-6240-2020 | 4/63A. 380V. 2 Ad. Ön - 1/16A. 220V. 2 Ad. Yan                         | IP66 | 1    | 6    | 4.596,00 TL |
| BD6-6245-2020 | 5/63A. 380V. 2 Ad. Ön - 1/16A. 220V. 2 Ad. Yan                         | IP66 | 1    | 6    | 5.377,00 TL |
| BD6-6302-2020 | 1/16A. 220V. 3 Ad. Ön - 1/16A. 220V. 2 Ad. Yan                         | IP66 | 1    | 6    | 3.128,00 TL |



12 SİGORTA KAPASİTELİ

| Ürün Kodu     | Açıklama   | IP   | Kutu | Koli | Fiyat       |
|---------------|--|------|------|------|-------------|
| BH6-2000-0000 | V Otamat Raylı 2 Klemensli Kombinasyon                                 | IP44 | 1    | 6    | 999,00 TL   |
| BH6-2118-2020 | 5/16A. 380V. 1 Ad. Ön - 1/16A. 220V. 2 Ad. Ön                          | IP44 | 1    | 6    | 1.566,00 TL |
| BH6-2118-2022 | 5/16A. 380V. 1 Ad. Ön - 1/16A. 220V. 2 Ad. Ön - 1/16A. 220V. 2 Ad. Yan | IP44 | 1    | 6    | 1.782,00 TL |
| BH6-2134-1182 | 5/32A. 380V. 1 Ad. Ön - 5/16A. 380V. 1 Ad. Ön - 1/16A. 220V. 2 Ad. Yan | IP44 | 1    | 6    | 2.001,00 TL |
| BH6-2134-1282 | 5/32A. 380V. 1 Ad. Ön - 4/32A. 380V. 1 Ad. Ön - 1/16A. 220V. 2 Ad. Yan | IP44 | 1    | 6    | 2.037,00 TL |
| BH6-2134-2020 | 5/32A. 380V. 1 Ad. Ön - 1/16A. 220V. 2 Ad. Ön                          | IP44 | 1    | 6    | 1.650,00 TL |
| BH6-2149-2020 | 5/63A. 380V. 1 Ad. Ön - 1/16A. 220V. 2 Ad. Ön                          | IP44 | 1    | 6    | 2.750,00 TL |
| BH6-2201-0000 | Ön 2 Ad. Delikli Boş Kombinasyon                                       | IP44 | 1    | 6    | 999,00 TL   |
| BH6-2201-2010 | Ön 2 Ad. Delikli Yan 2 Ad. Delikli Boş Kombinasyon                     | IP44 | 1    | 6    | 999,00 TL   |
| BH6-2201-2020 | Ön 2 Ad. Delikli 2 Ad. Yan 1/16A. 220V. Kombinasyon                    | IP44 | 1    | 6    | 1.215,00 TL |
| BH6-2205-0000 | 3/25A. 380V. 2 Ad. Ön  | IP44 | 1    | 6    | 1.335,00 TL |
| BH6-2205-2020 | Ön 2 Ad. 3/25A. 380V. Yan 2 Ad. 1/16A. 220V.                           | IP44 | 1    | 6    | 1.551,00 TL |
| BH6-2205-4020 | 3/25A. 380V. 2 Ad. Ön - 1/16A. 220V. 4 Ad. Yan                         | IP44 | 1    | 6    | 1.767,00 TL |
| BH6-2212-2020 | 4/16A. 380V. 2 Ad. Ön - 1/16A. 220V. 2 Ad. Yan                         | IP44 | 1    | 6    | 1.774,00 TL |
| BH6-2218-0000 | 5/16A. 380V. 2 Ad. Yan   | IP44 | 1    | 6    | 1.701,00 TL |
| BH6-2218-2020 | Ön 2 Ad. 5/16A. 380V. Yan 2Ad. 1/16A. 220V.                            | IP44 | 1    | 6    | 1.917,00 TL |
| BH6-2228-0000 | 4/32A. 380V. 2 Ad. Ön  | IP44 | 1    | 6    | 1.772,00 TL |
| BH6-2228-2020 | 4/32A. 380V. 2 Ad. Ön - 1/16A. 220V. 2 Ad. Yan                         | IP44 | 1    | 6    | 1.988,00 TL |
| BH6-2234-0000 | 5/32A. 380V. 2 Ad. Ön  | IP44 | 1    | 6    | 1.870,00 TL |
| BH6-2234-2020 | Ön 2 Ad. 5/32A. 380V. Yan 2 Ad. 1/16A. 220V.                           | IP44 | 1    | 6    | 2.086,00 TL |
| BH6-2234-4020 | 5/32A. 380V. 2 Ad. Ön - 1/16A. 220V. 4 Ad. Yan                         | IP44 | 1    | 6    | 2.302,00 TL |
| BH6-2249-2020 | 5/63A. 380V. 2 Ad. Ön - 1/16A. 220V. 2 Ad. Yan                         | IP44 | 1    | 6    | 4.285,00 TL |
| BH6-2802-4020 | 1/16A. 220V. 8 Ad. P.P. Ön - 1/16A. 220V. 4 Ad. P.P. Yan               | IP44 | 1    | 6    | 2.294,00 TL |
| BH6-6000-0000 | V Otamat Raylı 2 Klemensli Kombinasyon                                 | IP66 | 1    | 6    | 1.128,00 TL |
| BH6-6208-0000 | 4/16A. 380V. 2 Ad. Ön  | IP66 | 1    | 6    | 2.050,00 TL |
| BH6-6208-2020 | 4/16A. 380V. 2 Ad. Ön - 1/16A. 220V. 2 Ad. Yan                         | IP66 | 1    | 6    | 2.940,00 TL |
| BH6-6214-2020 | 5/16A. 380V. 2 Ad. Ön - 1/16A. 220V. 2 Ad. Yan                         | IP66 | 1    | 6    | 3.001,00 TL |
| BH6-6224-0000 | 4/32A. 380V. 2 Ad. Ön  | IP66 | 1    | 6    | 2.205,00 TL |
| BH6-6224-2020 | 4/32A. 380V. 2 Ad. Ön - 1/16A. 220V. 2 Ad. Yan                         | IP66 | 1    | 6    | 3.096,00 TL |
| BH6-6230-0000 | 5/32A. 380V. 2 Ad. Ön  | IP66 | 1    | 6    | 2.294,00 TL |
| BH6-6230-2020 | Ön 2 Ad. 5/32A. 380V. Yan 2 Ad. 1/16A. 220V. Som. Priz                 | IP66 | 1    | 6    | 3.209,00 TL |
| BH6-6240-2020 | 4/63A. 380V. 2 Ad. Ön - 1/16A. 220V. 2 Ad. Yan                         | IP66 | 1    | 6    | 4.824,00 TL |
| BH6-6245-2020 | 5/63A. 380V. 2 Ad. Ön - 1/16A. 220V. 2 Ad. Yan                         | IP66 | 1    | 6    | 5.605,00 TL |
| BH6-6302-2020 | 1/16A. 220V. 3 Ad. Ön - 1/16A. 220V. 2 Ad. Yan                         | IP66 | 1    | 6    | 3.355,00 TL |



| Ürün Kodu     | Açıklama   | IP   | Kutu | Koli | Fiyat       |
|---------------|--|------|------|------|-------------|
| BD9-2000-0000 | V Otomat Raylı Boş Kombinasyon                                     | IP44 | 1    | 3    | 1.141,00 TL |
| BD9-2134-1182 | 5/32A. 380V. 1 Ad. Ön-5/16A. 380V. 1 Ad. Ön-1/16A. 220V. 2 Ad. Yan | IP44 | 1    | 3    | 2.144,00 TL |
| BD9-2134-2120 | 5/32A. 380V. 1 Ad. Ön-4/16A. 380V. 2 Ad. Ön                        | IP44 | 1    | 3    | 2.136,00 TL |
| BD9-2144-1282 | 4/32A. 380V. 1 Ad. Ön-4/63A. 380V. 1 Ad. Ön-1/16A. 220V. 2 Ad. Yan | IP44 | 1    | 3    | 2.934,00 TL |
| BD9-2149-2120 | 5/63A. 380V. 1 Ad. Ön-4/16A. 380V. 2 Ad. Ön                        | IP44 | 1    | 3    | 3.236,00 TL |
| BD9-2201-2010 | Ön 2 Ad. Delikli Yan 2 Ad. Delikli Kombinasyon                     | IP44 | 1    | 3    | 1.141,00 TL |
| BD9-2205-1030 | 3/25A. 380V. 2 Ad. Ön-1/16A. 220V. 1 Ad. Ön                        | IP44 | 1    | 3    | 1.606,00 TL |
| BD9-2205-4020 | 3/25A. 380V. 2 Ad. Ön-1/16A. 220V. 4 Ad. Yan                       | IP44 | 1    | 3    | 1.909,00 TL |
| BD9-2218-2020 | Ön 2 Ad. 5/16A. 380V. Yan 2 Ad. 1/16A. 220V.                       | IP44 | 1    | 3    | 2.059,00 TL |
| BD9-2234-1020 | 5/32A. 380V. 2 Ad. Ön-1/16A. 220V. 1 Ad. P.P. Ön                   | IP44 | 1    | 3    | 2.120,00 TL |
| BD9-2234-1182 | 5/32A. 380V. 2 Ad. Ön-5/16A. 380V. 1 Ad. Ön-1/16A. 220V. 2 Ad. Yan | IP44 | 1    | 3    | 2.579,00 TL |
| BD9-2234-1232 | 5/32A. 380V. 2 Ad. Ön-3/32A. 220V. 1 Ad. Ön-1/16A. 220V. 2 Ad. Yan | IP44 | 1    | 3    | 2.575,00 TL |
| BD9-2234-2020 | Ön 2 Ad. 5/32A. 380V. Yan 2 Ad. 1/16A. 220V.                       | IP44 | 1    | 3    | 2.228,00 TL |
| BD9-2234-2024 | 5/32A. 380V. 2 Ad. Ön-1/16A. 220V. 2 Ad. Ön-1/16A. 220V. 4 Ad. Yan | IP44 | 1    | 3    | 2.660,00 TL |
| BD9-2234-4020 | 5/32A. 380V. 2 Ad. Ön-1/16A. 220V. 4 Ad. Yan                       | IP44 | 1    | 3    | 2.444,00 TL |
| BD9-2249-2020 | 5/63A. 380V. 2 Ad.-1/16A. 220V. 2 Ad. Yan                          | IP44 | 1    | 3    | 4.579,00 TL |
| BD9-2301-0000 | Ön 3 Ad. Delikli Boş Kombinasyon                                   | IP44 | 1    | 3    | 1.141,00 TL |
| BD9-2305-2020 | 3/25A. 380V. 3 Ad. Ön-1/16A. 220V. 2 Ad. Yan                       | IP44 | 1    | 3    | 1.861,00 TL |
| BD9-2318-2020 | 5/16A. 380V. 3 Ad. Ön-1/16A. 220V. 2 Ad. Yan                       | IP44 | 1    | 3    | 2.410,00 TL |
| BD9-2334-2020 | 5/32A. 380V. 3 Ad. Ön-1/16A. 220V. 2 Ad. Yan                       | IP44 | 1    | 3    | 2.664,00 TL |
| BD9-2602-6020 | 1/16A. 220V. 10 Ad. Ön-1/16A. 220V. 2 Ad. Yan                      | IP44 | 1    | 3    | 2.436,00 TL |
| BD9-6000-0000 | V Otomat Raylı Boş Kombinasyon                                     | IP66 | 1    | 3    | 1.377,00 TL |
| BD9-6000-2020 | 1/16A. 220V. 2 Ad. Somunlu Priz Yan                                | IP66 | 1    | 3    | 2.268,00 TL |
| BD9-6130-1020 | 5/32A. 380V. 1 Ad. Ön-1/16A. 220V. 1 Ad. Ön                        | IP66 | 1    | 3    | 2.406,00 TL |
| BD9-6130-1142 | 5/32A. 380V. 1 Ad. Ön-5/16A. 380V. 1 Ad. Ön-1/16A. 220V. 2 Ad. Yan | IP66 | 1    | 3    | 3.342,00 TL |
| BD9-6130-1241 | 4/32A. 380V. 1 Ad. Ön-5/32A. 380V. 1 Ad. Ön-1/16A. 220V. 1 Ad. Ön  | IP66 | 1    | 3    | 2.944,00 TL |
| BD9-6224-1302 | 5/32A. 380V. 1 Ad. Ön-4/32A. 380V. 2 Ad. Ön-1/16A. 220V. 2 Ad. Yan | IP66 | 1    | 3    | 3.927,00 TL |
| BD9-6230-2020 | 5/32A. 380V. 2 Ad. Ön-1/16A. 220V. 2 Ad. Yan                       | IP66 | 1    | 3    | 3.434,00 TL |
| BD9-6314-0000 | 5/16A. 380V. 3 Ad. Ön  | IP66 | 1    | 3    | 2.850,00 TL |
| BD9-6314-2020 | 5/16A. 380V. 3 Ad. Ön-1/16A. 220V. 2 Ad. Yan                       | IP66 | 1    | 3    | 3.463,00 TL |
| BD9-6324-2020 | 4/32A. 380V. 3 Ad. Ön-1/16A. 220V. 2 Ad. Yan                       | IP66 | 1    | 3    | 3.605,00 TL |
| BD9-6330-2020 | 5/32A. 380V. 3 Ad. Ön-1/16A. 220V. 2 Ad. Yan                       | IP66 | 1    | 3    | 3.739,00 TL |





**V15 Halogen Free KOMBİNASYON  
(300x325x140)****15 SİGORTA KAPASİTELİ**

| Ürün Kodu     | Açıklama   | IP   | Kutu | Koli | Fiyat       |
|---------------|--|------|------|------|-------------|
| BH9-2000-0000 | V Otomat Raylı Boş Kombinasyon                                     | IP44 | 1    | 3    | 1.342,00 TL |
| BH9-2134-1182 | 5/32A. 380V. 1 Ad. Ön-5/16A. 380V. 1 Ad. Ön-1/16A. 220V. 2 Ad. Yan | IP44 | 1    | 3    | 2.344,00 TL |
| BH9-2134-2120 | 5/32A. 380V. 1 Ad. Ön-4/16A. 380V. 2 Ad. Ön                        | IP44 | 1    | 3    | 2.336,00 TL |
| BH9-2144-1282 | 4/32A. 380V. 1 Ad. Ön-4/63A. 380V. 1 Ad. Ön-1/16A. 220V. 2 Ad. Yan | IP44 | 1    | 3    | 3.134,00 TL |
| BH9-2149-2120 | 5/63A. 380V. 1 Ad. Ön-4/16A. 380V. 2 Ad. Ön                        | IP44 | 1    | 3    | 3.436,00 TL |
| BH9-2201-2010 | Ön 2 Ad. Delikli Yan 2 Ad. Delikli Kombinasyon                     | IP44 | 1    | 3    | 1.341,00 TL |
| BH9-2205-1030 | 3/25A. 380V. 2 Ad. Ön-1/16A. 220V. 1 Ad. M.P. Ön                   | IP44 | 1    | 3    | 1.806,00 TL |
| BH9-2205-4020 | 3/25A. 380V. 2 Ad. Ön-1/16A. 220V. 4 Ad. Yan                       | IP44 | 1    | 3    | 2.109,00 TL |
| BH9-2218-2020 | Ön 2 Ad. 5/16A. 380V. Yan 2 Ad. 1/16A. 220V.                       | IP44 | 1    | 3    | 2.259,00 TL |
| BH9-2234-1020 | 5/32A. 380V. 2 Ad. Ön-1/16A. 220V. 1 Ad. P.P. Ön                   | IP44 | 1    | 3    | 2.320,00 TL |
| BH9-2234-1182 | 5/32A. 380V. 2 Ad. Ön-5/16A. 380V. 1 Ad. Ön-1/16A. 220V. 2 Ad. Yan | IP44 | 1    | 3    | 2.779,00 TL |
| BH9-2234-1232 | 5/32A. 380V. 2 Ad. Ön-3/32A. 220V. 1 Ad. Ön-1/16A. 220V. 2 Ad. Yan | IP44 | 1    | 3    | 2.775,00 TL |
| BH9-2234-2020 | Ön 2 Ad. 5/32A. 380V. Yan 2 Ad. 1/16A. 220V.                       | IP44 | 1    | 3    | 2.428,00 TL |
| BH9-2234-2024 | 5/32A. 380V. 2 Ad. Ön-1/16A. 220V. 2 Ad. Ön-1/16A. 220V. 4 Ad. Yan | IP44 | 1    | 3    | 2.860,00 TL |
| BH9-2234-4020 | 5/32A. 380V. 2 Ad. Ön-1/16A. 220V. 4 Ad. Yan                       | IP44 | 1    | 3    | 2.644,00 TL |
| BH9-2249-2020 | 5/63A. 380V. 2 Ad.-1/16A. 220V. 2 Ad. Yan                          | IP44 | 1    | 3    | 4.779,00 TL |
| BH9-2301-0000 | Ön 3 Ad. Delikli Boş Kombinasyon                                   | IP44 | 1    | 3    | 1.341,00 TL |
| BH9-2305-2020 | 3/25A. 380V. 3 Ad. Ön-1/16A. 220V. 2 Ad. Yan                       | IP44 | 1    | 3    | 2.061,00 TL |
| BH9-2318-2020 | 5/16A. 380V. 3 Ad. Ön-1/16A. 220V. 2 Ad. Yan                       | IP44 | 1    | 3    | 2.610,00 TL |
| BH9-2334-2020 | 5/32A. 380V. 3 Ad. Ön-1/16A. 220V. 2 Ad. Yan                       | IP44 | 1    | 3    | 2.864,00 TL |
| BH9-2602-6020 | 1/16A. 220V. 10 Ad. Ön-1/16A. 220V. 2 Ad. Yan                      | IP44 | 1    | 3    | 2.636,00 TL |
| BH9-6000-0000 | V Otomat Raylı Boş Kombinasyon                                     | IP66 | 1    | 3    | 1.578,00 TL |
| BH9-6000-2020 | 1/16A. 220V. 2 Ad. Somunlu Priz Yan                                | IP66 | 1    | 3    | 2.468,00 TL |
| BH9-6130-1020 | 5/32A. 380V. 1 Ad. Ön-1/16A. 220V. 1 Ad. Ön                        | IP66 | 1    | 3    | 2.606,00 TL |
| BH9-6130-1142 | 5/32A. 380V. 1 Ad. Ön-5/16A. 380V. 1 Ad. Ön-1/16A. 220V. 2 Ad. Yan | IP66 | 1    | 3    | 3.542,00 TL |
| BH9-6130-1241 | 4/32A. 380V. 1 Ad. Ön-5/32A. 380V. 1 Ad. Ön-1/16A. 220V. 1 Ad. Ön  | IP66 | 1    | 3    | 3.144,00 TL |
| BH9-6224-1302 | 5/32A. 380V. 1 Ad. Ön-4/32A. 380V. 2 Ad. Ön-1/16A. 220V. 2 Ad. Yan | IP66 | 1    | 3    | 4.127,00 TL |
| BH9-6230-2020 | 5/32A. 380V. 2 Ad. Ön-1/16A. 220V. 2 Ad. Yan                       | IP66 | 1    | 3    | 3.634,00 TL |
| BH9-6314-0000 | 5/16A. 380V. 3 Ad. Ön  | IP66 | 1    | 3    | 3.050,00 TL |
| BH9-6314-2020 | 5/16A. 380V. 3 Ad. Ön-1/16A. 220V. 2 Ad. Yan                       | IP66 | 1    | 3    | 3.663,00 TL |
| BH9-6324-2020 | 4/32A. 380V. 3 Ad. Ön-1/16A. 220V. 2 Ad. Yan                       | IP66 | 1    | 3    | 3.804,00 TL |
| BH9-6330-2020 | 5/32A. 380V. 3 Ad. Ön-1/16A. 220V. 2 Ad. Yan                       | IP66 | 1    | 3    | 3.939,00 TL |



| Ürün Kodu     | Açıklama   | IP   | Kutu | Koli | Fiyat       |
|---------------|--|------|------|------|-------------|
| BD4-2000-0000 | V Otomat Raylı Boş Kombinasyon   | IP44 | 1    | 5    | 1.727,00 TL |
| BD4-2123-1442 | 3/32A. 220V. 1 Ad. Ön-4/63A. 380V. 1 Ad. Ön-1/16A. 220V. 2 Ad. P.P. Ön | IP44 | 1    | 5    | 3.480,00 TL |
| BD4-2134-1182 | 5/32A. 380V. 1 Ad. Ön-5/16A. 380V. 1 Ad. Ön-1/16A. 220V. 2 Ad. Yan     | IP44 | 1    | 5    | 2.730,00 TL |
| BD4-2134-2120 | 5/32A. 380V. 1 Ad. Ön-4/16A. 380V. 2 Ad. Ön                            | IP44 | 1    | 5    | 2.723,00 TL |
| BD4-2134-3020 | 5/32A. 380V. 1 Ad. Ön-1/16A. 220V. 3 Ad. P.P. Ön                       | IP44 | 1    | 5    | 2.487,00 TL |
| BD4-2144-1282 | 4/32A. 380V. 1 Ad. Ön-4/63A. 380V. 1 Ad. Ön-1/16A. 220V. 2 Ad. Yan     | IP44 | 1    | 5    | 3.520,00 TL |
| BD4-2149-2120 | 5/63A. 380V. 1 Ad. Ön-4/16A. 380V. 2 Ad. Ön                            | IP44 | 1    | 5    | 3.822,00 TL |
| BD4-2201-2010 | Ön 2 Ad. Delikli Yan 2 Ad. Delikli Kombinasyon                         | IP44 | 1    | 5    | 1.727,00 TL |
| BD4-2205-1030 | 3/25A. 380V. 2 Ad. Ön-1/16A. 220V. 1 Ad. M.P. Ön                       | IP44 | 1    | 5    | 2.192,00 TL |
| BD4-2205-4020 | 3/25A. 380V. 2 Ad. Ön-1/16A. 220V. 4 Ad. Yan                           | IP44 | 1    | 5    | 2.495,00 TL |
| BD4-2218-2020 | Ön 2 Ad. 5/16A. 380V. Yan 2 Ad. 1/16A. 220V.                           | IP44 | 1    | 5    | 2.645,00 TL |
| BD4-2234-1020 | 5/32A. 380V. 2 Ad. Ön-1/16A. 220V. 1 Ad. P.P. Ön                       | IP44 | 1    | 5    | 2.707,00 TL |
| BD4-2234-1182 | 5/32A. 380V. 2 Ad. Ön-5/16A. 380V. 1 Ad. Ön-1/16A. 220V. 2 Ad. Yan     | IP44 | 1    | 5    | 3.166,00 TL |
| BD4-2234-1232 | 5/32A. 380V. 2 Ad. Ön-3/32A. 220V. 1 Ad. Ön-1/16A. 220V. 2 Ad. Yan     | IP44 | 1    | 5    | 3.161,00 TL |
| BD4-2234-2020 | Ön 2 Ad. 5/32A. 380V. Yan 2 Ad. 1/16A. 220V.                           | IP44 | 1    | 5    | 2.815,00 TL |
| BD4-2234-2024 | 5/32A. 380V. 2 Ad. Ön-1/16A. 220V. 2 Ad. Ön-1/16A. 220V. 4 Ad. Yan     | IP44 | 1    | 5    | 3.246,00 TL |
| BD4-2234-4020 | 5/32A. 380V. 2 Ad. Ön-1/16A. 220V. 4 Ad. Yan                           | IP44 | 1    | 5    | 3.031,00 TL |
| BD4-2249-2020 | 5/63A. 380V. 2 Ad.-1/16A. 220V. 2 Ad. Yan                              | IP44 | 1    | 5    | 5.166,00 TL |
| BD4-2301-0000 | Ön 3 Ad. Delikli Boş Kombinasyon                                       | IP44 | 1    | 5    | 1.727,00 TL |
| BD4-2305-2020 | Ön 3 Ad. 3/25A. 380V. Yan 2 Ad. 1/16A. 220V.                           | IP44 | 1    | 5    | 2.448,00 TL |
| BD4-2305-6020 | 3/25A. 380V. 3 Ad. Ön-1/16A. 220V. 6AD Yan                             | IP44 | 1    | 5    | 2.879,00 TL |
| BD4-2318-2020 | 5/16A. 380V. 3 Ad. Ön-1/16A. 220V. 2 Ad. Yan                           | IP44 | 1    | 5    | 2.996,00 TL |
| BD4-2318-4020 | 5/16A. 380V. 3 Ad. Ön-1/16A. 220V. 4 Ad. Yan                           | IP44 | 1    | 5    | 3.212,00 TL |
| BD4-2334-2020 | Ön 3 Ad. 5/32A. 380V. Yan 2 Ad. 1/16A. 220V.                           | IP44 | 1    | 5    | 3.250,00 TL |
| BD4-2334-4020 | 5/32A. 380V. 3 Ad. Ön-1/16A. 220V. 4 Ad. Yan                           | IP44 | 1    | 5    | 3.466,00 TL |
| BD4-2334-6020 | 5/32A. 380V. 3 Ad. Ön-1/16A. 220V. 6 Ad. Yan                           | IP44 | 1    | 5    | 3.682,00 TL |
| BD4-2602-6020 | 1/16A. 220V. 10 Ad. Ön-1/16A. 220V. 2 Ad. Yan                          | IP44 | 1    | 5    | 3.022,00 TL |
| BD4-6000-0000 | V Otomat Raylı Boş Kombinasyon   | IP66 | 1    | 5    | 1.900,00 TL |
| BD4-6000-2020 | 1/16A. 220V. 2 Ad. Somunlu Priz Yan                                    | IP66 | 1    | 5    | 2.791,00 TL |
| BD4-6130-1020 | 5/32A. 380V. 1 Ad. Ön-1/16A. 220V. 1 Ad. Ön                            | IP66 | 1    | 5    | 2.928,00 TL |
| BD4-6130-1142 | 5/32A. 380V. 1 Ad. Ön-5/16A. 380V. 1 Ad. Ön-1/16A. 220V. 2 Ad. Yan     | IP66 | 1    | 5    | 3.864,00 TL |
| BD4-6130-1241 | 4/32A. 380V. 1 Ad. Ön-5/32A. 380V. 1 Ad. Ön-1/16A. 220V. 1 Ad. Ön      | IP66 | 1    | 5    | 3.466,00 TL |
| BD4-6224-1302 | 5/32A. 380V. 1 Ad. Ön-4/32A. 380V. 2 Ad. Ön-1/16A. 220V. 2 Ad. Yan     | IP66 | 1    | 5    | 4.450,00 TL |
| BD4-6230-2020 | 5/32A. 380V. 2 Ad. Ön-1/16A. 220V. 2 Ad. Yan                           | IP66 | 1    | 5    | 3.956,00 TL |
| BD4-6230-4020 | Ön 2 Ad. 5/32A. 380V. Yan 4 Ad. 1/16A. 220V. Som. Priz                 | IP66 | 1    | 5    | 4.847,00 TL |
| BD4-6314-0000 | 5/16A. 380V. 3 Ad. Ön  | IP66 | 1    | 5    | 3.373,00 TL |
| BD4-6314-2020 | 5/16A. 380V. 3 Ad. Ön-1/16A. 220V. 2 Ad. Yan                           | IP66 | 1    | 5    | 3.985,00 TL |
| BD4-6324-2020 | 4/32A. 380V. 3 Ad. Ön-1/16A. 220V. 2 Ad. Yan                           | IP66 | 1    | 5    | 4.127,00 TL |
| BD4-6330-2020 | 5/32A. 380V. 3 Ad. Ön-1/16A. 220V. 2 Ad. Yan                           | IP66 | 1    | 5    | 4.262,00 TL |



17 SİGORTA KAPASİTELİ

| Ürün Kodu     | Açıklama   | IP   | Kutu | Koli | Fiyat       |
|---------------|--|------|------|------|-------------|
| BH4-2000-0000 | V Otomat Raylı Boş Kombinasyon   | IP44 | 1    | 5    | 1.927,00 TL |
| BH4-2123-1442 | 3/32A. 220V. 1 Ad. Ön-4/63A. 380V. 1 Ad. Ön-1/16A. 220V. 2 Ad. P.P. Ön | IP44 | 1    | 5    | 3.680,00 TL |
| BH4-2134-1182 | 5/32A. 380V. 1 Ad. Ön-5/16A. 380V. 1 Ad. Ön-1/16A. 220V. 2 Ad. Yan     | IP44 | 1    | 5    | 2.930,00 TL |
| BH4-2134-2120 | 5/32A. 380V. 1 Ad. Ön-4/16A. 380V. 2 Ad. Ön                            | IP44 | 1    | 5    | 2.923,00 TL |
| BH4-2134-3020 | 5/32A. 380V. 1 Ad. Ön-1/16A. 220V. 3 Ad. P.P. Ön                       | IP44 | 1    | 5    | 2.687,00 TL |
| BH4-2144-1282 | 4/32A. 380V. 1 Ad. Ön-4/63A. 380V. 1 Ad. Ön-1/16A. 220V. 2 Ad. Yan     | IP44 | 1    | 5    | 3.720,00 TL |
| BH4-2149-2120 | 5/63A. 380V. 1 Ad. Ön-4/16A. 380V. 2 Ad. Ön                            | IP44 | 1    | 5    | 4.022,00 TL |
| BH4-2201-2010 | Ön 2 Ad. Delikli Yan 2 Ad. Delikli Kombinasyon                         | IP44 | 1    | 5    | 1.927,00 TL |
| BH4-2205-1030 | 3/25A. 380V. 2 Ad. Ön-1/16A. 220V. 1 Ad. M.P. Ön                       | IP44 | 1    | 5    | 2.392,00 TL |
| BH4-2205-4020 | 3/25A. 380V. 2 Ad. Ön-1/16A. 220V. 4 Ad. Yan                           | IP44 | 1    | 5    | 2.695,00 TL |
| BH4-2218-2020 | Ön 2 Ad. 5/16A. 380V. Yan 2 Ad. 1/16A. 220V.                           | IP44 | 1    | 5    | 2.845,00 TL |
| BH4-2234-1020 | 5/32A. 380V. 2 Ad. Ön-1/16A. 220V. 1 Ad. P.P. Ön                       | IP44 | 1    | 5    | 2.907,00 TL |
| BH4-2234-1182 | 5/32A. 380V. 2 Ad. Ön-5/16A. 380V. 1 Ad. Ön-1/16A. 220V. 2 Ad. Yan     | IP44 | 1    | 5    | 3.366,00 TL |
| BH4-2234-1232 | 5/32A. 380V. 2 Ad. Ön-3/32A. 220V. 1 Ad. Ön-1/16A. 220V. 2 Ad. Yan     | IP44 | 1    | 5    | 3.361,00 TL |
| BH4-2234-2020 | Ön 2 Ad. 5/32A. 380V. Yan 2 Ad. 1/16A. 220V.                           | IP44 | 1    | 5    | 3.015,00 TL |
| BH4-2234-2024 | 5/32A. 380V. 2 Ad. Ön-1/16A. 220V. 2 Ad. Ön-1/16A. 220V. 4 Ad. Yan     | IP44 | 1    | 5    | 3.446,00 TL |
| BH4-2234-4020 | 5/32A. 380V. 2 Ad. Ön-1/16A. 220V. 4 Ad. Yan                           | IP44 | 1    | 5    | 3.230,00 TL |
| BH4-2249-2020 | 5/63A. 380V. 2 Ad.-1/16A. 220V. 2 Ad. Yan                              | IP44 | 1    | 5    | 5.214,00 TL |
| BH4-2301-0000 | Ön 3 Ad. Delikli Boş Kombinasyon                                       | IP44 | 1    | 5    | 1.927,00 TL |
| BH4-2305-2020 | Ön 3 Ad. 3/25A. 380V. Yan 2 Ad. 1/16A. 220V.                           | IP44 | 1    | 5    | 2.648,00 TL |
| BH4-2305-6020 | 3/25A. 380V. 3 Ad. Ön-1/16A. 220V. 6AD Yan                             | IP44 | 1    | 5    | 3.079,00 TL |
| BH4-2318-2020 | 5/16A. 380V. 3 Ad. Ön-1/16A. 220V. 2 Ad. Yan                           | IP44 | 1    | 5    | 3.196,00 TL |
| BH4-2318-4020 | 5/16A. 380V. 3 Ad. Ön-1/16A. 220V. 4 Ad. Yan                           | IP44 | 1    | 5    | 3.412,00 TL |
| BH4-2334-2020 | Ön 3 Ad. 5/32A. 380V. Yan 2 Ad. 1/16A. 220V.                           | IP44 | 1    | 5    | 3.450,00 TL |
| BH4-2334-4020 | 5/32A. 380V. 3 Ad. Ön-1/16A. 220V. 4 Ad. Yan                           | IP44 | 1    | 5    | 3.666,00 TL |
| BH4-2334-6020 | 5/32A. 380V. 3 Ad. Ön-1/16A. 220V. 6 Ad. Yan                           | IP44 | 1    | 5    | 3.882,00 TL |
| BH4-2602-6020 | 1/16A. 220V. 10 Ad. Ön-1/16A. 220V. 2 Ad. Yan                          | IP44 | 1    | 5    | 3.222,00 TL |
| BH4-6000-0000 | V Otomat Raylı Boş Kombinasyon   | IP66 | 1    | 5    | 2.164,00 TL |
| BH4-6000-2020 | 1/16A. 220V. 2 Ad. Somunlu Priz Yan                                    | IP66 | 1    | 5    | 3.055,00 TL |
| BH4-6130-1020 | 5/32A. 380V. 1 Ad. Ön-1/16A. 220V. 1 Ad. Ön                            | IP66 | 1    | 5    | 3.192,00 TL |
| BH4-6130-1142 | 5/32A. 380V. 1 Ad. Ön-5/16A. 380V. 1 Ad. Ön-1/16A. 220V. 2 Ad. Yan     | IP66 | 1    | 5    | 4.129,00 TL |
| BH4-6130-1241 | 4/32A. 380V. 1 Ad. Ön-5/32A. 380V. 1 Ad. Ön-1/16A. 220V. 1 Ad. Ön      | IP66 | 1    | 5    | 3.730,00 TL |
| BH4-6224-1302 | 5/32A. 380V. 1 Ad. Ön-4/32A. 380V. 2 Ad. Ön-1/16A. 220V. 2 Ad. Yan     | IP66 | 1    | 5    | 4.714,00 TL |
| BH4-6230-2020 | 5/32A. 380V. 2 Ad. Ön-1/16A. 220V. 2 Ad. Yan                           | IP66 | 1    | 5    | 4.220,00 TL |
| BH4-6230-4020 | Ön 2 Ad. 5/32A. 380V. Yan 4 Ad. 1/16A. 220V. Som. Priz                 | IP66 | 1    | 5    | 5.111,00 TL |
| BH4-6314-0000 | 5/16A. 380V. 3 Ad. Ön  | IP66 | 1    | 5    | 3.637,00 TL |
| BH4-6314-2020 | 5/16A. 380V. 3 Ad. Ön-1/16A. 220V. 2 Ad. Yan                           | IP66 | 1    | 5    | 4.528,00 TL |
| BH4-6324-2020 | 4/32A. 380V. 3 Ad. Ön-1/16A. 220V. 2 Ad. Yan                           | IP66 | 1    | 5    | 4.669,00 TL |
| BH4-6330-2020 | 5/32A. 380V. 3 Ad. Ön-1/16A. 220V. 2 Ad. Yan                           | IP66 | 1    | 5    | 4.803,00 TL |



YENİ

B**bemis**
**V20 KOMBİNASYON**  
**(220x500x140)**
**20 SİGORTA KAPASİTELİ**

| Ürün Kodu      | Açıklama  | IP   | Kutu | Koli | Fiyat       |
|----------------|---|------|------|------|-------------|
| BD10-2000-0000 | V Otomat Raylı Boş Kombinasyon  | IP44 | 4    | 0    | 1.850,00 TL |
| BD10-2401-2010 | Ön 4 Ad. Delikli - Yan 2 Ad. Delikli Kombinasyon                      | IP44 | 4    | 0    | 1.850,00 TL |
| BD10-2401-2020 | Ön 4 Ad. Delikli - Yan 2 Ad. 1/16A. 220V. Pano Priz                   | IP44 | 4    | 0    | 2.057,00 TL |
| BD10-2205-4020 | Ön 2 Ad. 3/25A. 380V. - Yan 4 Ad. 1/16A. 220V. Pano Priz              | IP44 | 4    | 0    | 2.638,00 TL |
| BD10-2228-2020 | Ön 2 Ad. 4/32A. 380V. - Yan 2 Ad. 1/16A. 220V. Pano Priz              | IP44 | 4    | 0    | 2.871,00 TL |
| BD10-2234-2020 | Ön 2 Ad. 5/32A. 380V. - Yan 2 Ad. 1/16A. 220V. Pano Priz              | IP44 | 4    | 0    | 2.974,00 TL |
| BD10-2134-1184 | Ön 1 Ad. 5/32A. - 1 Ad. 5/16A. 380V. - Yan 4 Ad. 1/16A. 220V. P. Priz | IP44 | 4    | 0    | 3.091,00 TL |
| BD10-2234-2184 | Ön 2 Ad. 5/32A. - 2 Ad. 5/16A. 380V. - Yan 4 Ad. 1/16A. 220V. P. Priz | IP44 | 4    | 0    | 3.920,00 TL |
| BD10-2405-4020 | Ön 4 Ad. 3/25A. 380V. - Yan 4 ad. 1/16A. 220V. Pano Priz              | IP44 | 4    | 0    | 3.013,00 TL |
| BD10-2418-2020 | Ön 4 Ad. 5/16A. 380V. - Yan 2 Ad. 1/16A. 220V. Pano Priz              | IP44 | 4    | 0    | 3.535,00 TL |
| BD10-2428-2020 | Ön 4 Ad. 4/32A. 380V. - Yan 2 Ad. 1/16A. 220V. Pano Priz              | IP44 | 4    | 0    | 3.686,00 TL |
| BD10-2434-2020 | Ön 4 Ad. 5/32A. 380V. - Yan 2 Ad. 1/16A. 220V. Pano Priz              | IP44 | 4    | 0    | 3.892,00 TL |
| BD10-2434-4020 | Ön 4 Ad. 5/32A. 380V. - Yan 4 Ad. 1/16A. 220V. Pano Priz              | IP44 | 4    | 0    | 4.098,00 TL |
| BD10-2602-0000 | Ön 6 Ad. 1/16A. 220V. Pano Priz                                       | IP44 | 4    | 0    | 2.469,00 TL |
| BD10-2602-6020 | Ön 6 Ad. 1/16A. 220V. - Yan 6 Ad. 1/16A. 220V. Pano Priz              | IP44 | 4    | 0    | 3.088,00 TL |
| BD10-2244-2020 | Ön 2 Ad. 4/63A. 380V. - Yan 2 Ad. 1/16A. 220V. Pano Priz              | IP44 | 4    | 0    | 4.563,00 TL |
| BD10-2249-2020 | Ön 2 Ad. 5/63A. 380V. - Yan 2 Ad. 1/16A. 220V. Pano Priz              | IP44 | 4    | 0    | 5.289,00 TL |
| BD10-6000-0000 | V Otomat Raylı Boş Kombinasyon  | IP66 | 4    | 0    | 2.100,00 TL |
| BD10-6414-2020 | Ön 4 Ad. 5/16A. 380V. - Yan 2 Ad. 1/16A. 220V. Pano Priz              | IP66 | 4    | 0    | 5.034,00 TL |
| BD10-6430-2020 | Ön 4 Ad. 5/32A. 380V. - Yan 2 Ad. 1/16A. 220V. Pano Priz              | IP66 | 4    | 0    | 5.421,00 TL |
| BD10-6424-2020 | Ön 4 Ad. 4/32A. 380V. - Yan 2 Ad. 1/16A. 220V. Pano Priz              | IP66 | 4    | 0    | 5.233,00 TL |
| BD10-6430-4020 | Ön 4 Ad. 5/32A. 380V. - Yan 4 Ad. 1/16A. 220V. Pano Priz              | IP66 | 4    | 0    | 6.287,00 TL |
| BD10-6240-2020 | Ön 2 Ad. 4/63A. 380V. - Yan 2 Ad. 1/16A. 220V. Pano Priz              | IP66 | 4    | 0    | 5.919,00 TL |
| BD10-6245-2020 | Ön 2 Adet 5/63A. 380V. - Yan 2 Ad. 1/16A. 220V. Pano Priz             | IP66 | 4    | 0    | 6.741,00 TL |

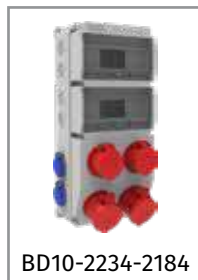

**20 SİGORTA KAPASİTELİ**

| Ürün Kodu      | Açıklama  | IP   | Kutu | Koli | Fiyat       |
|----------------|---|------|------|------|-------------|
| BH10-2000-0000 | V Otomat Raylı Boş Kombinasyon  | IP44 | 4    | 0    | 2.050,00 TL |
| BH10-2401-2010 | Ön 4 Ad. Delikli - Yan 2 Ad. Delikli Kombinasyon                      | IP44 | 4    | 0    | 2.050,00 TL |
| BH10-2401-2020 | Ön 4 Ad. Delikli - Yan 2 Ad. 1/16A. 220V. Pano Priz                   | IP44 | 4    | 0    | 2.257,00 TL |
| BH10-2205-4020 | Ön 2 Ad. 3/25A. 380V. - Yan 4 Ad. 1/16A. 220V. Pano Priz              | IP44 | 4    | 0    | 2.838,00 TL |
| BH10-2228-2020 | Ön 2 Ad. 4/32A. 380V. - Yan 2 Ad. 1/16A. 220V. Pano Priz              | IP44 | 4    | 0    | 3.071,00 TL |
| BH10-2234-2020 | Ön 2 Ad. 5/32A. 380V. - Yan 2 Ad. 1/16A. 220V. Pano Priz              | IP44 | 4    | 0    | 3.174,00 TL |
| BH10-2134-1184 | Ön 1 Ad. 5/32A. - 1 Ad. 5/16A. 380V. - Yan 4 Ad. 1/16A. 220V. P. Priz | IP44 | 4    | 0    | 3.291,00 TL |
| BH10-2234-2184 | Ön 2 Ad. 5/32A. - 2 Ad. 5/16A. 380V. - Yan 4 Ad. 1/16A. 220V. P. Priz | IP44 | 4    | 0    | 4.120,00 TL |
| BH10-2405-4020 | Ön 4 Ad. 3/25A. 380V. - Yan 4 ad. 1/16A. 220V. Pano Priz              | IP44 | 4    | 0    | 3.213,00 TL |
| BH10-2418-2020 | Ön 4 Ad. 5/16A. 380V. - Yan 2 Ad. 1/16A. 220V. Pano Priz              | IP44 | 4    | 0    | 3.735,00 TL |
| BH10-2428-2020 | Ön 4 Ad. 4/32A. 380V. - Yan 2 Ad. 1/16A. 220V. Pano Priz              | IP44 | 4    | 0    | 3.886,00 TL |
| BH10-2434-2020 | Ön 4 Ad. 5/32A. 380V. - Yan 2 Ad. 1/16A. 220V. Pano Priz              | IP44 | 4    | 0    | 4.092,00 TL |
| BH10-2434-4020 | Ön 4 Ad. 5/32A. 380V. - Yan 4 Ad. 1/16A. 220V. Pano Priz              | IP44 | 4    | 0    | 4.298,00 TL |
| BH10-2602-0000 | Ön 6 Ad. 1/16A. 220V. Pano Priz                                       | IP44 | 4    | 0    | 2.669,00 TL |
| BH10-2602-6020 | Ön 6 Ad. 1/16A. 220V. - Yan 6 Ad. 1/16A. 220V. Pano Priz              | IP44 | 4    | 0    | 3.288,00 TL |
| BH10-2244-2020 | Ön 2 Ad. 4/63A. 380V. - Yan 2 Ad. 1/16A. 220V. Pano Priz              | IP44 | 4    | 0    | 4.763,00 TL |
| BH10-2249-2020 | Ön 2 Ad. 5/63A. 380V. - Yan 2 Ad. 1/16A. 220V. Pano Priz              | IP44 | 4    | 0    | 5.489,00 TL |
| BH10-6000-0000 | V Otomat Raylı Boş Kombinasyon  | IP66 | 4    | 0    | 2.300,00 TL |
| BH10-6414-2020 | Ön 4 Ad. 5/16A. 380V. - Yan 2 Ad. 1/16A. 220V. Pano Priz              | IP66 | 4    | 0    | 5.234,00 TL |
| BH10-6430-2020 | Ön 4 Ad. 5/32A. 380V. - Yan 2 Ad. 1/16A. 220V. Pano Priz              | IP66 | 4    | 0    | 5.621,00 TL |
| BH10-6424-2020 | Ön 4 Ad. 4/32A. 380V. - Yan 2 Ad. 1/16A. 220V. Pano Priz              | IP66 | 4    | 0    | 5.433,00 TL |
| BH10-6430-4020 | Ön 4 Ad. 5/32A. 380V. - Yan 4 Ad. 1/16A. 220V. Pano Priz              | IP66 | 4    | 0    | 6.487,00 TL |
| BH10-6240-2020 | Ön 2 Ad. 4/63A. 380V. - Yan 2 Ad. 1/16A. 220V. Pano Priz              | IP66 | 4    | 0    | 6.119,00 TL |
| BH10-6245-2020 | Ön 2 Adet 5/63A. 380V. - Yan 2 Ad. 1/16A. 220V. Pano Priz             | IP66 | 4    | 0    | 6.941,00 TL |

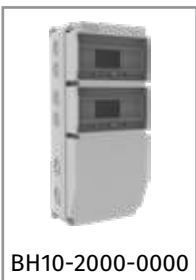

| Ürün Kodu     | Açıklama  | IP   | Kutu | Koli | Fiyat        |
|---------------|---|------|------|------|--------------|
| BD8-2000-0000 | 2 Ad. V Otomat Raylı Boş Kombinasyon                                  | IP44 | 2    | 0    | 2.861,00 TL  |
| BD8-2134-1186 | 5/32A. 380V. 1 Ad. - 5/16A. 380V. 1 Ad. - 1/16A. 220V. 6 Ad. P.P. Ön  | IP44 | 2    | 0    | 4.294,00 TL  |
| BD8-2205-4020 | 3/25A. 380V. 2 Ad. - 1/16A. 220V. 4 Ad. P.P. Ön                       | IP44 | 2    | 0    | 3.628,00 TL  |
| BD8-2205-4030 | 3/25A. 380V. 2 Ad. - 1/16A. 220V. 4 Ad. M.P. Ön                       | IP44 | 2    | 0    | 3.711,00 TL  |
| BD8-2218-2070 | 5/16A. 380V. 2 Ad. - 3/16A. 220V. 2 Ad. Ön                            | IP44 | 2    | 0    | 4.036,00 TL  |
| BD8-2218-6020 | 5/16A. 380V. 2 Ad. - 1/16A. 220V. 6 Ad. P.P. Ön                       | IP44 | 2    | 0    | 4.209,00 TL  |
| BD8-2228-3124 | 4/16A. 380V. 3 Ad. - 4/32A. 380V. 2 Ad. - 1/16A. 220V. 4 Ad. P.P.     | IP44 | 2    | 0    | 4.904,00 TL  |
| BD8-2228-6020 | 4/32A. 380V. 2 Ad. - 1/16A. 220V. 6 Ad. P.P. Ön                       | IP44 | 2    | 0    | 4.281,00 TL  |
| BD8-2234-2236 | 5/32A. 380V. 2 Ad. - 3/32A. 220V. 2 Ad. - 1/16A. 220V. 6 Ad. P.P. Ön  | IP44 | 2    | 0    | 5.072,00 TL  |
| BD8-2234-2494 | 5/32A. 380V. 2 Ad. - 5/63A. 380V. 2 Ad. - 1/16A. 220V. 4 Ad. P.P.     | IP44 | 2    | 0    | 7.233,00 TL  |
| BD8-2234-3184 | 5/16A. 380V. 3 Ad. - 5/32A. 380V. 2 Ad. - 1/16A. 220V. 4 Ad. P.P.     | IP44 | 2    | 0    | 5.216,00 TL  |
| BD8-2234-4020 | 5/32A. 380V. 2 Ad. - 1/16A. 220V. 4 Ad. P.P. Ön                       | IP44 | 2    | 0    | 4.163,00 TL  |
| BD8-2234-6020 | 5/32A. 380V. 2 Ad. - 1/16A. 220V. 6 Ad. P.P. Ön                       | IP44 | 2    | 0    | 4.379,00 TL  |
| BD8-2249-6020 | 5/63A. 380V. 2 Ad. - 1/16A. 220V. 6 Ad. Ön                            | IP44 | 2    | 0    | 6.578,00 TL  |
| BD8-2305-5025 | 3/25A. 380V. 3 Ad. - 1/16A. 220V. 10 Ad. P.P. Ön                      | IP44 | 2    | 0    | 4.443,00 TL  |
| BD8-2328-4020 | 4/32A. 380V. 3 Ad. - 1/16A. 220V. 4 Ad. P.P. Ön                       | IP44 | 2    | 0    | 4.452,00 TL  |
| BD8-2334-2020 | 5/32A. 380V. 3 Ad. - 1/16A. 220V. 2 Ad. P.P. Ön                       | IP44 | 2    | 0    | 4.383,00 TL  |
| BD8-2334-3070 | 5/32A. 380V. 3 Ad. - 3/16A. 220V. 3 Ad. Ön                            | IP44 | 2    | 0    | 4.878,00 TL  |
| BD8-2334-3184 | 5/16A. 380V. 3 Ad. - 5/32A. 380V. 3 Ad. - 1/16A. 220V. 4 Ad. P.P. Yan | IP44 | 2    | 0    | 5.652,00 TL  |
| BD8-2405-4020 | Ön 4 Ad. 3/25A. 380V. Ön 4 Ad. 1/16A. 220V. Pano Priz                 | IP44 | 2    | 0    | 3.964,00 TL  |
| BD8-2405-6020 | 3/25A. 380V. 4 Ad. - 1/16A. 220V. 6 Ad. P.P.                          | IP44 | 2    | 0    | 4.180,00 TL  |
| BD8-2418-6020 | 5/16A. 380V. 4 Ad. - 1/16A. 220V. 6 Ad. P.P.                          | IP44 | 2    | 0    | 4.911,00 TL  |
| BD8-2428-4020 | 4/32A. 380V. 4 Ad. - 1/16A. 220V. 4 Ad. P.P. Ön                       | IP44 | 2    | 0    | 4.838,00 TL  |
| BD8-2434-0000 | 5/32A. 380V. 4 Ad. Ön   | IP44 | 2    | 0    | 4.603,00 TL  |
| BD8-2434-2020 | Ön 4 Ad. 5/32A. 380V. Ön 2 Ad. 1/16A. 220V. Pano Priz                 | IP44 | 2    | 0    | 4.818,00 TL  |
| BD8-2434-4020 | Ön 4 Ad. 5/32A. 380V. Ön 4 Ad. 1/16A. 220V. Pano Priz                 | IP44 | 2    | 0    | 5.034,00 TL  |
| BD8-2502-5029 | 1/16A. 220V. 19 Ad. P.P. Ön   | IP44 | 2    | 0    | 4.910,00 TL  |
| BD8-2505-6020 | 3/25A. 380V. 5 Ad. - 1/16A. 220V. 6 Ad. P.P.                          | IP44 | 2    | 0    | 4.348,00 TL  |
| BD8-2518-6020 | 5/16A. 380V. 5 Ad. - 1/16A. 220V. 6 Ad. P.P.                          | IP44 | 2    | 0    | 5.262,00 TL  |
| BD8-2605-4020 | 3/25A. 380V. 6 Ad. - 1/16A. 220V. 4 Ad. P.P.                          | IP44 | 2    | 0    | 4.300,00 TL  |
| BD8-2612-0000 | 4/16A. 380V. 6 Ad. Ön   | IP44 | 2    | 0    | 4.538,00 TL  |
| BD8-2618-4020 | 5/16A. 380V. 6 Ad. - 1/16A. 220V. 4 Ad. P.P. Yan                      | IP44 | 2    | 0    | 5.398,00 TL  |
| BD8-2634-0000 | 5/32A. 380V. 6Ad. Ön  | IP44 | 2    | 0    | 5.474,00 TL  |
| BD8-6000-0000 | 2 Ad. V Otomat Raylı Boş Kombinasyon                                  | IP66 | 2    | 0    | 3.019,00 TL  |
| BD8-6224-4020 | 4/32A. 380V. 2 Ad. - 1/16A. 220V. 4 Ad. Somunlu Priz Ön               | IP66 | 2    | 0    | 5.878,00 TL  |
| BD8-6230-4032 | 5/32A. 380V. 2 Ad. - 3/16A. 220V. 4 Ad. - 1/16A. 220V. 2 Ad. Yan      | IP66 | 2    | 0    | 6.616,00 TL  |
| BD8-6245-2304 | 5/32A. 380V. 2 Ad. - 5/63A. 380V. 2 Ad. - 1/16A. 220V. 4 Ad.          | IP66 | 2    | 0    | 9.552,00 TL  |
| BD8-6255-0000 | 4/125A. 380V. 2 Ad. Ön  | IP66 | 2    | 0    | 10.907,00 TL |
| BD8-6260-2450 | 5/125A. 380V. 2 Ad. - 5/63A. 380V. 2 Ad.                              | IP66 | 2    | 0    | 14.624,00 TL |
| BD8-6330-2450 | 5/32A. 380V. 3 Ad. - 5/63A. 380V. 2 Ad.                               | IP66 | 2    | 0    | 8.353,00 TL  |
| BD8-6330-3140 | 5/32A. 380V. 3 Ad. - 5/16A. 380V. 3 Ad.                               | IP66 | 2    | 0    | 6.241,00 TL  |
| BD8-6430-4020 | 5/32A. 380V. 4 Ad. - 1/16A. 220V. 2 Ad. Ön - 1/16A. 220V. 2 Ad. Yan   | IP66 | 2    | 0    | 7.132,00 TL  |
| BD8-6614-0000 | 5/16A. 380V. 6 Ad.  | IP66 | 2    | 0    | 5.965,00 TL  |
| BD8-6630-0000 | 5/32A. 380V. 6 Ad.  | IP66 | 2    | 0    | 6.516,00 TL  |
| BD8-6630-4020 | Ön 6 Ad. 5/32A. 380V. Yan 4 Ad. 1/16A. 220V. Som. Priz                | IP66 | 2    | 0    | 8.406,00 TL  |



BD8-2228-3124



BD8-2234-2494

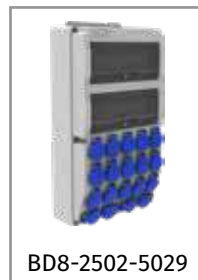

BD8-2502-5029



BD8-6230-4032



BD8-6330-2450



BD8-6630-0000

26 SİGORTA KAPASİTELİ

| Ürün Kodu     | Açıklama  | IP   | Kutu | Koli | Fiyat        |
|---------------|---|------|------|------|--------------|
| BH8-2000-0000 | 2 Ad. V Otomat Raylı Boş Kombinasyon                                  | IP44 | 2    | 0    | 3.386,00 TL  |
| BH8-2134-1186 | 5/32A. 380V. 1 Ad. - 5/16A. 380V. 1 Ad. - 1/16A. 220V. 6 Ad. P.P. Ön  | IP44 | 2    | 0    | 4.820,00 TL  |
| BH8-2205-4020 | 3/25A. 380V. 2 Ad. - 1/16A. 220V. 4 Ad. P.P. Ön                       | IP44 | 2    | 0    | 4.154,00 TL  |
| BH8-2205-4030 | 3/25A. 380V. 2 Ad. - 1/16A. 220V. 4 Ad. M.P. Ön                       | IP44 | 2    | 0    | 4.237,00 TL  |
| BH8-2218-2070 | 5/16A. 380V. 2 Ad. - 3/16A. 220V. 2 Ad. Ön                            | IP44 | 2    | 0    | 4.562,00 TL  |
| BH8-2218-6020 | 5/16A. 380V. 2 Ad. - 1/16A. 220V. 6 Ad. P.P. Ön                       | IP44 | 2    | 0    | 4.735,00 TL  |
| BH8-2228-3124 | 4/16A. 380V. 3 Ad. - 4/32A. 380V. 2 Ad. - 1/16A. 220V. 4 Ad. P.P.     | IP44 | 2    | 0    | 5.430,00 TL  |
| BH8-2228-6020 | 4/32A. 380V. 2 Ad. - 1/16A. 220V. 6 Ad. P.P. Ön                       | IP44 | 2    | 0    | 4.807,00 TL  |
| BH8-2234-2236 | 5/32A. 380V. 2 Ad. - 3/32A. 220V. 2 Ad. - 1/16A. 220V. 6 Ad. P.P.     | IP44 | 2    | 0    | 5.598,00 TL  |
| BH8-2234-2494 | 5/32A. 380V. 2 Ad. - 5/63A. 380V. 2 Ad. - 1/16A. 220V. 4 Ad. P.P.     | IP44 | 2    | 0    | 7.760,00 TL  |
| BH8-2234-3184 | 5/16A. 380V. 3 Ad. - 5/32A. 380V. 2 Ad. - 1/16A. 220V. 4 Ad. P.P.     | IP44 | 2    | 0    | 5.742,00 TL  |
| BH8-2234-4020 | 5/32A. 380V. 2 Ad. - 1/16A. 220V. 4 Ad. P.P. Ön                       | IP44 | 2    | 0    | 4.689,00 TL  |
| BH8-2234-6020 | 5/32A. 380V. 2 Ad. - 1/16A. 220V. 6 Ad. P.P. Ön                       | IP44 | 2    | 0    | 4.905,00 TL  |
| BH8-2249-6020 | 5/63A. 380V. 2 Ad. - 1/16A. 220V. 6 Ad. Ön                            | IP44 | 2    | 0    | 7.104,00 TL  |
| BH8-2305-5025 | 3/25A. 380V. 3 Ad. - 1/16A. 220V. 10 Ad. P.P. Ön                      | IP44 | 2    | 0    | 4.969,00 TL  |
| BH8-2328-4020 | 4/32A. 380V. 3 Ad. - 1/16A. 220V. 4 Ad. P.P. Ön                       | IP44 | 2    | 0    | 4.978,00 TL  |
| BH8-2334-2020 | 5/32A. 380V. 3 Ad. - 1/16A. 220V. 2 Ad. P.P. Ön                       | IP44 | 2    | 0    | 4.909,00 TL  |
| BH8-2334-3070 | 5/32A. 380V. 3 Ad. - 3/16A. 220V. 3 Ad. Ön                            | IP44 | 2    | 0    | 5.404,00 TL  |
| BH8-2334-3184 | 5/16A. 380V. 3 Ad. - 5/32A. 380V. 3 Ad. - 1/16A. 220V. 4 Ad. P.P. Yan | IP44 | 2    | 0    | 6.178,00 TL  |
| BH8-2405-4020 | Ön 4 Ad. 3/25A. 380V. Ön 4 Ad. 1/16A. 220V. Pano Priz                 | IP44 | 2    | 0    | 4.490,00 TL  |
| BH8-2405-6020 | 3/25A. 380V. 4 Ad. - 1/16A. 220V. 6 Ad. P.P.                          | IP44 | 2    | 0    | 4.706,00 TL  |
| BH8-2418-6020 | 5/16A. 380V. 4 Ad. - 1/16A. 220V. 6 Ad. P.P.                          | IP44 | 2    | 0    | 5.438,00 TL  |
| BH8-2428-4020 | 4/32A. 380V. 4 Ad. - 1/16A. 220V. 4 Ad. P.P. Ön                       | IP44 | 2    | 0    | 5.364,00 TL  |
| BH8-2434-0000 | 5/32A. 380V. 4 Ad. Ön   | IP44 | 2    | 0    | 5.129,00 TL  |
| BH8-2434-2020 | Ön 4 Ad. 5/32A. 380V. Ön 2 Ad. 1/16A. 220V. Pano Priz                 | IP44 | 2    | 0    | 5.345,00 TL  |
| BH8-2434-4020 | Ön 4 Ad. 5/32A. 380V. Ön 4 Ad. 1/16A. 220V. Pano Priz                 | IP44 | 2    | 0    | 5.560,00 TL  |
| BH8-2502-5029 | 1/16A. 220V. 19 Ad. P.P. Ön   | IP44 | 2    | 0    | 5.436,00 TL  |
| BH8-2505-6020 | 3/25A. 380V. 5 Ad. - 1/16A. 220V. 6 Ad. P.P.                          | IP44 | 2    | 0    | 4.874,00 TL  |
| BH8-2518-6020 | 5/16A. 380V. 5 Ad. - 1/16A. 220V. 6 Ad. P.P.                          | IP44 | 2    | 0    | 5.789,00 TL  |
| BH8-2605-4020 | 3/25A. 380V. 6 Ad. - 1/16A. 220V. 4 Ad. P.P.                          | IP44 | 2    | 0    | 4.826,00 TL  |
| BH8-2612-0000 | 4/16A. 380V. 6 Ad. Ön   | IP44 | 2    | 0    | 5.064,00 TL  |
| BH8-2618-4020 | 5/16A. 380V. 6 Ad. - 1/16A. 220V. 4 Ad. P.P. Yan                      | IP44 | 2    | 0    | 5.924,00 TL  |
| BH8-2634-0000 | 5/32A. 380V. 6Ad. Ön  | IP44 | 2    | 0    | 6.000,00 TL  |
| BH8-6000-0000 | 2 Ad. V Otomat Raylı Boş Kombinasyon                                  | IP66 | 2    | 0    | 3.764,00 TL  |
| BH8-6224-4020 | 4/32A. 380V. 2 Ad. - 1/16A. 220V. 4 Ad. Somunlu Priz Ön               | IP66 | 2    | 0    | 6.622,00 TL  |
| BH8-6230-4032 | 5/32A. 380V. 2 Ad. - 3/16A. 220V. 4 Ad. - 1/16A. 220V. 2 Ad. Yan      | IP66 | 2    | 0    | 7.360,00 TL  |
| BH8-6245-2304 | 5/32A. 380V. 2 Ad. - 5/63A. 380V. 2 Ad. - 1/16A. 220V. 4 Ad.          | IP66 | 2    | 0    | 10.296,00 TL |
| BH8-6255-0000 | 4/125A. 380V. 2 Ad. Ön  | IP66 | 2    | 0    | 11.651,00 TL |
| BH8-6260-2450 | 5/125A. 380V. 2 Ad. - 5/63A. 380V. 2 Ad.                              | IP66 | 2    | 0    | 15.369,00 TL |
| BH8-6330-2450 | 5/32A. 380V. 3 Ad. - 5/63A. 380V. 2 Ad.                               | IP66 | 2    | 0    | 9.097,00 TL  |
| BH8-6330-3140 | 5/32A. 380V. 3 Ad. - 5/16A. 380V. 3 Ad.                               | IP66 | 2    | 0    | 6.985,00 TL  |
| BH8-6430-4020 | 5/32A. 380V. 4 Ad. - 1/16A. 220V. 2 Ad. Ön - 1/16A. 220V. 2 Ad. Yan   | IP66 | 2    | 0    | 7.877,00 TL  |
| BH8-6614-0000 | 5/16A. 380V. 6 Ad.  | IP66 | 2    | 0    | 6.709,00 TL  |
| BH8-6630-0000 | 5/32A. 380V. 6 Ad.  | IP66 | 2    | 0    | 7.260,00 TL  |
| BH8-6630-4020 | Ön 6 Ad. 5/32A. 380V. Yan 4 Ad. 1/16A. 220V. Som. Priz                | IP66 | 2    | 0    | 9.152,00 TL  |

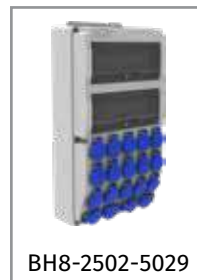



**MONTAJLI KOMBİNASYONLAR'da sigortalar müşteri tarafından sağlanması halinde sigorta montajı ücretsiz olarak yapılır.**



## Kablo Montajlı Kombinasyonlar

V5 - V7 - V10 - V12 - V15 - V17 - V26



**IP67**

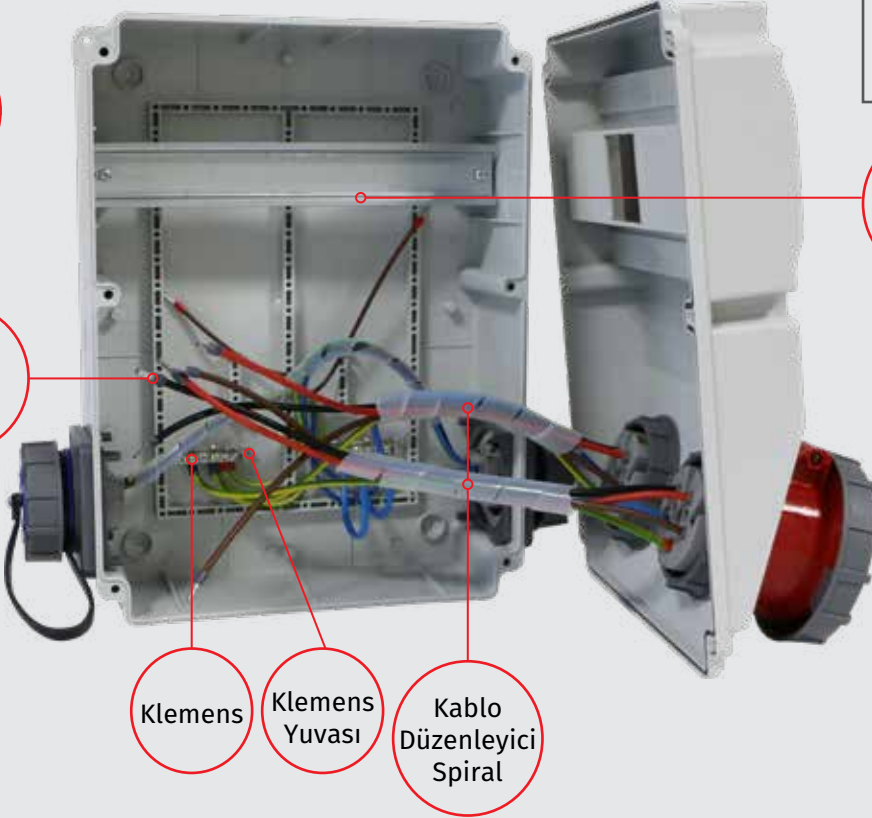

**V10**



**IP44**



**V7**



**V5 KABLO MONTAJLI KOMBİNASYON**

| Ürün Kodu     | Açıklama  | IP   | Kutu | Koli | Fiyat       |
|---------------|---|------|------|------|-------------|
| BD1M2105-2020 | 3/25A. 380V. 1 Ad. Ön - 1/16A. 220V. 2 Ad. Yan (ABS)                | IP44 | 1    | 12   | 1.050,00 TL |
| BD1M2118-2020 | 5/16A. 380V. 1 Ad. Ön - 1/16A. 220V. 2 Ad. Yan (ABS)                | IP44 | 1    | 12   | 1.264,00 TL |
| BD1M2134-2020 | 5/32A. 380V. 1 Ad. Ön - 1/16A. 220V. 2 Ad. Yan (ABS)                | IP44 | 1    | 12   | 1.348,00 TL |
| BH1M2105-2020 | 3/25A. 380V. 1 Ad. Ön - 1/16A. 220V. 2 Ad. Yan (ABS-H.F.)           | IP44 | 1    | 12   | 1.133,00 TL |
| BH1M2118-2020 | 5/16A. 380V. 1 Ad. Ön - 1/16A. 220V. 2 Ad. Yan (ABS-H.F.)           | IP44 | 1    | 12   | 1.349,00 TL |
| BH1M2134-2020 | 5/32A. 380V. 1 Ad. Ön - 1/16A. 220V. 2 Ad. Yan (ABS-H.F.)           | IP44 | 1    | 12   | 1.434,00 TL |
| BD1M6114-2020 | 5/16A. 380V. IP67 1 Ad. Ön - 1/16A. 220V. IP68 2 ad. Yan (ABS)      | IP66 | 1    | 12   | 1.939,00 TL |
| BD1M6130-2020 | 5/32A. 380V. IP67 1 Ad. Ön - 1/16A. 220V. IP68 2 ad. Yan (ABS)      | IP66 | 1    | 12   | 2.156,00 TL |
| BH1M6114-2020 | 5/16A. 380V. IP67 1 Ad. Ön - 1/16A. 220V. IP68 2 ad. Yan (ABS-H.F.) | IP66 | 1    | 12   | 2.030,00 TL |
| BH1M6130-2020 | 5/32A. 380V. IP67 1 Ad. Ön - 1/16A. 220V. IP68 2 ad. Yan (ABS-H.F.) | IP66 | 1    | 12   | 2.226,00 TL |

**V7 KABLO MONTAJLI KOMBİNASYON**

| Ürün Kodu     | Açıklama  | IP   | Kutu | Koli | Fiyat       |
|---------------|---|------|------|------|-------------|
| BD5M2105-2020 | 3/25A. 380V. 1 Ad. Ön - 1/16A. 220V. 2 Ad. Yan (ABS)      | IP44 | 1    | 12   | 1.190,00 TL |
| BD5M2118-2020 | 5/16A. 380V. 1 Ad. Ön - 1/16A. 220V. 2 Ad. Yan (ABS)      | IP44 | 1    | 12   | 1.407,00 TL |
| BD5M2134-2020 | 5/32A. 380V. 1 Ad. Ön - 1/16A. 220V. 2 Ad. Yan (ABS)      | IP44 | 1    | 12   | 1.491,00 TL |
| BH5M2105-2020 | 3/25A. 380V. 1 Ad. Ön - 1/16A. 220V. 2 Ad. Yan (ABS-H.F.) | IP44 | 1    | 12   | 1.181,00 TL |
| BH5M2118-2020 | 5/16A. 380V. 1 Ad. Ön - 1/16A. 220V. 2 Ad. Yan (ABS-H.F.) | IP44 | 1    | 12   | 1.397,00 TL |
| BH5M2134-2020 | 5/32A. 380V. 1 Ad. Ön - 1/16A. 220V. 2 Ad. Yan (ABS-H.F.) | IP44 | 1    | 12   | 1.482,00 TL |
| BD5M6114-2020 | 5/16A. 380V. 1 Ad. Ön - 1/16A. 220V. 2 Ad. Yan (ABS)      | IP66 | 1    | 12   | 2.227,00 TL |
| BD5M6130-2020 | 5/32A. 380V. 1 Ad. Ön - 1/16A. 220V. 2 Ad. Yan (ABS)      | IP66 | 1    | 12   | 2.318,00 TL |
| BH5M6114-2020 | 5/16A. 380V. 1 Ad. Ön - 1/16A. 220V. 2 Ad. Yan (ABS-H.F.) | IP66 | 1    | 12   | 2.264,00 TL |
| BH5M6130-2020 | 5/32A. 380V. 1 Ad. Ön - 1/16A. 220V. 2 Ad. Yan (ABS-H.F.) | IP66 | 1    | 12   | 2.356,00 TL |

**V10 KABLO MONTAJLI KOMBİNASYON**

| Ürün Kodu     | Açıklama  | IP   | Kutu | Koli | Fiyat       |
|---------------|---|------|------|------|-------------|
| BD2M2205-2020 | 3/25A. 380V. 2 Ad. Ön - 1/16A. 220V. 2 Ad. Yan (ABS)                | IP44 | 1    | 6    | 1.643,80 TL |
| BD2M2218-2020 | 5/16A. 380V. 2 Ad. Ön - 1/16A. 220V. 2 Ad. Yan (ABS)                | IP44 | 1    | 6    | 2.075,80 TL |
| BD2M2234-2020 | 5/32A. 380V. 2 Ad. Ön - 1/16A. 220V. 2 Ad. Yan (ABS)                | IP44 | 1    | 6    | 2.245,80 TL |
| BH2M2205-2020 | 3/25A. 380V. 2 Ad. Ön - 1/16A. 220V. 2 Ad. Yan (ABS-H.F.)           | IP44 | 1    | 6    | 1.828,00 TL |
| BH2M2218-2020 | 5/16A. 380V. 2 Ad. Ön - 1/16A. 220V. 2 Ad. Yan (ABS-H.F.)           | IP44 | 1    | 6    | 2.261,00 TL |
| BH2M2234-2020 | 5/32A. 380V. 2 Ad. Ön - 1/16A. 220V. 2 Ad. Yan (ABS-H.F.)           | IP44 | 1    | 6    | 2.431,00 TL |
| BD2M6214-2020 | 5/16A. 380V. IP67 2 Ad. Ön - 1/16A. 220V. IP68 2 Ad. Yan (ABS)      | IP66 | 1    | 6    | 2.885,00 TL |
| BD2M6230-2020 | 5/32A. 380V. IP67 2 Ad. Ön - 1/16A. 220V. IP68 2 Ad. Yan (ABS)      | IP66 | 1    | 6    | 3.348,00 TL |
| BH2M6214-2020 | 5/16A. 380V. IP67 2 Ad. Ön - 1/16A. 220V. IP68 2 Ad. Yan (ABS-H.F.) | IP66 | 1    | 6    | 3.033,00 TL |
| BH2M6230-2020 | 5/32A. 380V. IP67 2 Ad. Ön - 1/16A. 220V. IP68 2 Ad. Yan (ABS-H.F.) | IP66 | 1    | 6    | 3.487,00 TL |

**V12 KABLO MONTAJLI KOMBİNASYON**

| Ürün Kodu     | Açıklama   | IP   | Kutu | Koli | Fiyat       |
|---------------|--|------|------|------|-------------|
| BD6M2205-2020 | 3/25A. 380V. 2 Ad. Ön - 1/16A. 220V. 2 Ad. Yan (ABS)           | IP44 | 1    | 6    | 1.828,00 TL |
| BD6M2218-2020 | 5/16A. 380V. 2 Ad. Ön - 1/16A. 220V. 2 Ad. Yan (ABS)           | IP44 | 1    | 6    | 2.261,00 TL |
| BD6M2234-2020 | 5/32A. 380V. 2 Ad. Ön - 1/16A. 220V. 2 Ad. Yan (ABS)           | IP44 | 1    | 6    | 2.431,00 TL |
| BH6M2205-2020 | 3/25A. 380V. 2 Ad. Ön - 1/16A. 220V. 2 Ad. Yan (ABS-H.F.)      | IP44 | 1    | 6    | 1.962,00 TL |
| BH6M2218-2020 | 5/16A. 380V. 2 Ad. Ön - 1/16A. 220V. 2 Ad. Yan (ABS-H.F.)      | IP44 | 1    | 6    | 2.394,00 TL |
| BH6M2234-2020 | 5/32A. 380V. 2 Ad. Ön - 1/16A. 220V. 2 Ad. Yan (ABS-H.F.)      | IP44 | 1    | 6    | 2.564,00 TL |
| BD6M6214-2020 | 5/16A. 380V. 2 Ad. Ön - 1/16A. 220V. 2 Ad. M.P. Yan (ABS)      | IP66 | 1    | 6    | 3.322,00 TL |
| BD6M6230-2020 | 5/32A. 380V. 2 Ad. Ön - 1/16A. 220V. 2 Ad. M.P. Yan (ABS)      | IP66 | 1    | 6    | 3.506,00 TL |
| BH6M6214-2020 | 5/16A. 380V. 2 Ad. Ön - 1/16A. 220V. 2 Ad. M.P. Yan (ABS-H.F.) | IP66 | 1    | 6    | 3.479,00 TL |
| BH6M6230-2020 | 5/32A. 380V. 2 Ad. Ön - 1/16A. 220V. 2 Ad. M.P. Yan (ABS-H.F.) | IP66 | 1    | 6    | 3.662,00 TL |

MONTAJLI KOMBİNASYONLAR'da sigortalar müşteri tarafından sağlanması halinde sigorta montajı ücretsiz olarak yapılır.

**V15 KABLO MONTAJLI KOMBİNASYON**

| Ürün Kodu     | Açıklama   | IP   | Kutu | Koli | Fiyat       |
|---------------|--|------|------|------|-------------|
| BD9M2305-2020 | 3/25A. 380V. 3 Ad. Ön - 1/16A. 220V. 2 Ad. Yan (ABS)           | IP44 | 1    | 2    | 2.406,00 TL |
| BD9M2318-2020 | 5/16A. 380V. 3 Ad. Ön - 1/16A. 220V. 2 Ad. Yan (ABS)           | IP44 | 1    | 2    | 3.055,00 TL |
| BD9M2334-2020 | 5/32A. 380V. 3 Ad. Ön - 1/16A. 220V. 2 Ad. Yan (ABS)           | IP44 | 1    | 2    | 3.309,00 TL |
| BH9M2305-2020 | 3/25A. 380V. 3 Ad. Ön - 1/16A. 220V. 2 Ad. Yan (ABS-H.F.)      | IP44 | 1    | 2    | 2.606,00 TL |
| BH9M2318-2020 | 5/16A. 380V. 3 Ad. Ön - 1/16A. 220V. 2 Ad. Yan (ABS-H.F.)      | IP44 | 1    | 2    | 3.255,00 TL |
| BH9M2334-2020 | 5/32A. 380V. 3 Ad. Ön - 1/16A. 220V. 2 Ad. Yan (ABS-H.F.)      | IP44 | 1    | 2    | 3.509,00 TL |
| BD9M6314-2020 | 5/16A. 380V. 3 Ad. Ön - 1/16A. 220V. 2 Ad. M.P. Yan (ABS)      | IP66 | 1    | 2    | 4.387,00 TL |
| BD9M6330-2020 | 5/32A. 380V. 3 Ad. Ön - 1/16A. 220V. 2 Ad. M.P. Yan (ABS)      | IP66 | 1    | 2    | 4.662,00 TL |
| BH9M6314-2020 | 5/16A. 380V. 3 Ad. Ön - 1/16A. 220V. 2 Ad. M.P. Yan (ABS-H.F.) | IP66 | 1    | 2    | 4.586,00 TL |
| BH9M6330-2020 | 5/32A. 380V. 3 Ad. Ön - 1/16A. 220V. 2 Ad. M.P. Yan (ABS-H.F.) | IP66 | 1    | 2    | 4.862,00 TL |

**V17 KABLO MONTAJLI KOMBİNASYON**

| Ürün Kodu     | Açıklama   | IP   | Kutu | Koli | Fiyat       |
|---------------|--|------|------|------|-------------|
| BD4M2305-2020 | 3/25A. 380V. 3 Ad. Ön - 1/16A. 220V. 2 Ad. Yan (ABS)           | IP44 | 1    | 2    | 2.992,00 TL |
| BD4M2318-2020 | 5/16A. 380V. 3 Ad. Ön - 1/16A. 220V. 2 Ad. Yan (ABS)           | IP44 | 1    | 2    | 3.642,00 TL |
| BD4M2334-2020 | 5/32A. 380V. 3 Ad. Ön - 1/16A. 220V. 2 Ad. Yan (ABS)           | IP44 | 1    | 2    | 3.896,00 TL |
| BH4M2305-2020 | 3/25A. 380V. 3 Ad. Ön - 1/16A. 220V. 2 Ad. Yan (ABS-H.F.)      | IP44 | 1    | 2    | 3.192,00 TL |
| BH4M2318-2020 | 5/16A. 380V. 3 Ad. Ön - 1/16A. 220V. 2 Ad. Yan (ABS-H.F.)      | IP44 | 1    | 2    | 3.842,00 TL |
| BH4M2334-2020 | 5/32A. 380V. 3 Ad. Ön - 1/16A. 220V. 2 Ad. Yan (ABS-H.F.)      | IP44 | 1    | 2    | 4.096,00 TL |
| BD4M6314-2020 | 5/16A. 380V. 3 Ad. Ön - 1/16A. 220V. 2 Ad. M.P. Yan (ABS)      | IP66 | 1    | 2    | 4.973,00 TL |
| BD4M6330-2020 | 5/32A. 380V. 3 Ad. Ön - 1/16A. 220V. 2 Ad. M.P. Yan (ABS)      | IP66 | 1    | 2    | 5.248,00 TL |
| BH4M6314-2020 | 5/16A. 380V. 3 Ad. Ön - 1/16A. 220V. 2 Ad. M.P. Yan (ABS-H.F.) | IP66 | 1    | 2    | 5.173,00 TL |
| BH4M6330-2020 | 5/32A. 380V. 3 Ad. Ön - 1/16A. 220V. 2 Ad. M.P. Yan (ABS-H.F.) | IP66 | 1    | 2    | 5.448,00 TL |

**V20 KABLO MONTAJLI KOMBİNASYON**

| Ürün Kodu      | Açıklama   | IP   | Kutu | Koli | Fiyat       |
|----------------|--|------|------|------|-------------|
| BD10M2234-2184 | 5/32A. 380V. 2 Ad. - 5/16A. 380V. 2 Ad. Ön - 1/16A. 220V. 4 Ad. Yan (ABS)      | IP44 | 1    | 4    | 5.125,00 TL |
| BD10M2418-2020 | 5/16A. 380V. 4 Ad. Ön - 1/16A. 220V. 2 Ad. Yan (ABS)                           | IP44 | 1    | 4    | 4.258,00 TL |
| BD10M2434-4020 | 5/32A. 380V. 4 Ad. Ön - 1/16A. 220V. 4 Ad. Yan (ABS)                           | IP44 | 1    | 4    | 4.942,00 TL |
| BD10M2249-2020 | 5/63A. 380V. 2 Ad. Ön - 1/16A. 220V. 2 Ad. Yan (ABS)                           | IP44 | 1    | 4    | 5.885,00 TL |
| BD10M6430-2020 | 5/32A. 380V. 4 Ad. Ön - 1/16A. 220V. 2 Ad. Yan (ABS)                           | IP67 | 1    | 4    | 6.144,00 TL |
| BD10M6240-2020 | 4/63A. 380V. 2 Ad. Ön - 1/16A. 220V. 2 Ad. Yan (ABS)                           | IP67 | 1    | 4    | 6.420,00 TL |
| BH10M2234-2184 | 5/32A. 380V. 2 Ad. - 5/16A. 380V. 2 Ad. Ön - 1/16A. 220V. 4 Ad. Yan (ABS-H.F.) | IP44 | 1    | 4    | 5.324,50 TL |
| BH10M2418-2020 | 5/16A. 380V. 4 Ad. Ön - 1/16A. 220V. 2 Ad. Yan (ABS-H.F.)                      | IP44 | 1    | 4    | 4.458,00 TL |
| BH10M2434-4020 | 5/32A. 380V. 4 Ad. Ön - 1/16A. 220V. 4 Ad. Yan (ABS-H.F.)                      | IP44 | 1    | 4    | 5.142,00 TL |
| BH10M2249-2020 | 5/63A. 380V. 2 Ad. Ön - 1/16A. 220V. 2 Ad. Yan (ABS-H.F.)                      | IP44 | 1    | 4    | 6.085,00 TL |
| BH10M6430-2020 | 5/32A. 380V. 4 Ad. Ön - 1/16A. 220V. 2 Ad. Yan (ABS-H.F.)                      | IP66 | 1    | 4    | 6.344,00 TL |
| BH10M6240-2020 | 4/63A. 380V. 2 Ad. Ön - 1/16A. 220V. 2 Ad. Yan (ABS-H.F.)                      | IP66 | 1    | 4    | 6.620,00 TL |

**V26 KABLO MONTAJLI KOMBİNASYON**

| Ürün Kodu     | Açıklama   | IP   | Kutu | Koli | Fiyat       |
|---------------|--|------|------|------|-------------|
| BD8M2405-4020 | 4 Ad. 3/25A. 380V. Ön - 4 Ad. 1/16A. 220V. Ön Pano Priz (ABS)      | IP44 | 1    | 0    | 4.785,00 TL |
| BD8M2418-4020 | 5/16A. 380V. 4 Ad. Ön - 1/16A. 220V. 4 Ad. Yan (ABS)               | IP44 | 1    | 0    | 5.651,00 TL |
| BD8M2434-4020 | 4 Ad. 5/32A. 380V. Ön - 4 Ad. 1/16A. 220V. Ön Pano Priz (ABS)      | IP44 | 1    | 0    | 5.990,00 TL |
| BH8M2405-4020 | 4 Ad. 3/25A. 380V. Ön - 4 Ad. 1/16A. 220V. Ön Pano Priz (ABS-H.F.) | IP44 | 1    | 0    | 5.311,00 TL |
| BH8M2418-4020 | 5/16A. 380V. 4 Ad. Ön - 1/16A. 220V. 4 Ad. Yan (ABS-H.F.)          | IP44 | 1    | 0    | 6.177,00 TL |
| BH8M2434-4020 | 4 Ad. 5/32A. 380V. Ön - 4 Ad. 1/16A. 220V. Ön Pano Priz (ABS-H.F.) | IP44 | 1    | 0    | 6.516,00 TL |
| BD8M6230-8030 | 2 Ad. 5/32A. 380V. Ön - 8 Ad. 1/16A. 220V. Ön Pano Priz (ABS)      | IP66 | 1    | 0    | 8.654,00 TL |
| BD8M6414-4020 | 5/16A. 380V. 4 Ad. Ön - 1/16A. 220V. 4 Ad. Yan (ABS)               | IP66 | 1    | 0    | 7.720,00 TL |
| BH8M6230-8030 | 2 Ad. 5/32A. 380V. Ön - 8 Ad. 1/16A. 220V. Ön Pano Priz (ABS-H.F.) | IP66 | 1    | 0    | 9.398,00 TL |
| BH8M6414-4020 | 5/16A. 380V. 4 Ad. Ön - 1/16A. 220V. 4 Ad. Yan (ABS-H.F.)          | IP66 | 1    | 0    | 8.465,00 TL |

MONTAJLI KOMBİNASYONLAR'da sigortalar müşteri tarafından sağlanması halinde sigorta montajı ücretsiz olarak yapılır.

| Ürün Kodu     | Açıklama  | IP   | Kutu | Koli | Fiyat       |
|---------------|---|------|------|------|-------------|
| BD8A2000-0000 | Boş Arabalı Kombinasyon                                     | IP44 | 1    | 0    | 6.114,00 TL |
| BD8A2234-4020 | 5/32A. 380V. 2 Ad. - 1/16A. 220V. 4 Ad. Arabalı Kombinasyon | IP44 | 1    | 0    | 7.687,00 TL |
| BD8A2418-4020 | 5/16A. 380V. 4 Ad. - 1/16A. 220V. 4 Ad. Arabalı Kombinasyon | IP44 | 1    | 0    | 8.218,00 TL |
| BD8A2434-4020 | 5/32A. 380V. 4 Ad. - 1/16A. 220V. 4 Ad. Arabalı Kombinasyon | IP44 | 1    | 0    | 8.764,00 TL |
| BD8A6224-4020 | 4/32A. 380V. 2 Ad. - 1/16A. 220V. 4 Ad. Arabalı Kombinasyon | IP66 | 1    | 0    | 8.434,00 TL |
| BD8A6230-4020 | 5/32A. 380V. 2 Ad. - 1/16A. 220V. 4 ad. Arabalı Kombinasyon | IP66 | 1    | 0    | 8.568,00 TL |



## Mini Kombinasyon (120x170x110) IP44 / IP67 Modellerimiz



### MİNİ KOMBİNASYON (120x170x110)

| Ürün Kodu     | Açıklama  | IP   | Kutu | Koli | Fiyat       |
|---------------|---|------|------|------|-------------|
| BD7-2000-0000 | Boş Kombinasyon 120X170X110   | IP44 | 1    | 16   | 330,00 TL   |
| BD7-2107-0000 | Ön 1 Ad. 3/16A. 220V. Makine Priz                                   | IP44 | 1    | 16   | 579,00 TL   |
| BD7-2107-1090 | Ön 1 Ad. Pako Şalter Ön 1 Ad. 3/16A. 220V. Makine Priz              | IP44 | 1    | 16   | 1.037,00 TL |
| BD7-2107-2020 | Ön 2 Ad. 1/16A. 220V. Pano Priz Ön 1 Ad. 3/16A. 220V. Makine Priz   | IP44 | 1    | 16   | 785,00 TL   |
| BD7-2118-0000 | Ön 1 Ad. 5/16A. 380V. Makine Priz                                   | IP44 | 1    | 16   | 699,00 TL   |
| BD7-2118-1090 | Ön 1 Ad. Pako Şalter Ön 1 Ad. 5/16A. 380V. Makine Priz              | IP44 | 1    | 16   | 1.413,00 TL |
| BD7-2118-2020 | Ön 2 Ad. 1/16A. 220V. Pano Priz Ön 1 Ad. 5/16A. 380V. Makine Priz   | IP44 | 1    | 16   | 905,00 TL   |
| BD7-2134-0000 | Ön 1 Ad. 5/32A. 380V. Makine Priz                                   | IP44 | 1    | 16   | 788,00 TL   |
| BD7-2134-1090 | Ön 1 Ad. Pako Şalter Ön 1 Ad. 5/32A. 380V. Makine Priz              | IP44 | 1    | 16   | 2.272,00 TL |
| BD7-2134-2020 | Ön 2 Ad. 1/16A. 220V. Pano Priz Ön 1 Ad. 5/32A. 380V. Makine Priz   | IP44 | 1    | 16   | 994,00 TL   |
| BD7-2402-0000 | Ön 4 Ad. 1/16A. 220V. Pano Priz                                     | IP44 | 1    | 16   | 742,00 TL   |
| BD7-2402-2020 | Ön 4 Ad. 1/16A. 220V. Yan 2 Ad. 1/16A. 220V. Pano Priz              | IP44 | 1    | 16   | 948,00 TL   |
| BD7-6000-0000 | Boş Kombinasyon 120X170X110   | IP66 | 1    | 16   | 364,00 TL   |
| BD7-6103-0000 | Ön 1 Ad. 3/16A. 220V. Makine Priz                                   | IP66 | 1    | 16   | 769,00 TL   |
| BD7-6103-1090 | Ön 1 Ad. Pako Şalter Ön 1 Ad. 3/16A. 220V. Makine Priz              | IP65 | 1    | 16   | 1.199,00 TL |
| BD7-6114-0000 | Ön 1 Ad. 5/16A. 380V. Makine Priz                                   | IP66 | 1    | 16   | 881,00 TL   |
| BD7-6114-1090 | Ön 1 Ad. Pako Şalter Ön 1 Ad. 5/16A. 380V. Makine Priz              | IP65 | 1    | 16   | 1.578,00 TL |
| BD7-6114-1092 | Ön 1 Ad. Pako Şalter 1 Ad. 5/16A. 380V. Yan 2 Ad. 1/16A. 220V. M.P. | IP66 | 1    | 16   | 1.681,00 TL |
| BD7-6114-2020 | Ön 1 Ad. 5/16A. 380V. Yan 2 Ad. 1/16A. 220V. Makine Priz            | IP65 | 1    | 16   | 1.381,00 TL |
| BD7-6130-0000 | Ön 1 Ad. 5/32A. 380V. Makine Priz                                   | IP66 | 1    | 16   | 977,00 TL   |
| BD7-6130-1090 | Ön 1 Ad. Pako Şalter Ön 1 Ad. 5/32A. 380V. Makine Priz              | IP66 | 1    | 16   | 2.436,00 TL |
| BD7-6130-1092 | Ön 1 Ad. Pako Şalter 1 Ad. 5/32A. 380V. Yan 2 Ad. 1/16A. 220V. M.P. | IP65 | 1    | 16   | 2.543,00 TL |
| BD7-6130-2020 | Ön 1 Ad. 5/32A. 380V. Yan 2 Ad. 1/16A. 220V. Makine Priz            | IP65 | 1    | 16   | 1.521,00 TL |



BD7-2000-0000



BD7-2402-0000



BD7-2402-2020



BD7-2107-4020



BD7-6103-4020

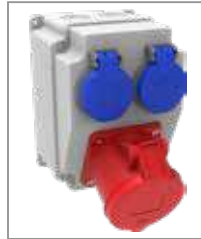

BD7-2134-2020

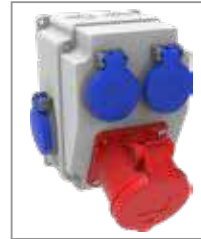

BD7-2134-4020



BD7-2107-1090



BD7-6130-2020



BD7-6103-1090



BD7-6130-1090



BD7-6130-1092

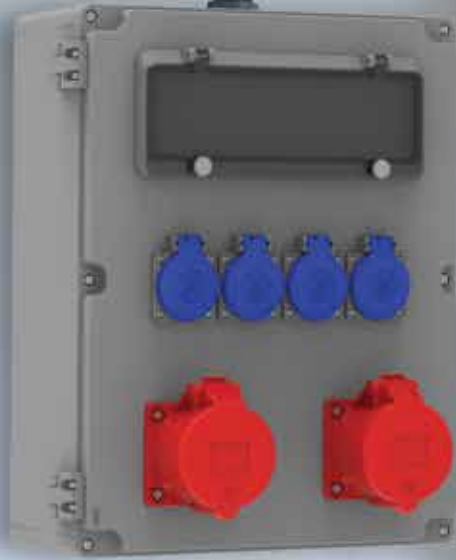

 **bemis**

# Alüminyum

*kombinasyon kutusu ile  
dayanıklı, uzun ömürlü  
endüstriyel çözümler  
sunuyoruz.*



# Alüminyum Kombinasyon Modellerimiz



## 190x350x90

| Ürün Kodu     | Açıklama  | Sigorta Kap.   | IP   | Koli | Fiyat       |
|---------------|---|----------------|------|------|-------------|
| BB4-7162-8210 | 5/32A. 380V. 2 ADET ÖN 1/16A. 220V. 2 ADET YAN          | 8 Sigorta Kap. | IP67 | 1    | 8.625,00 TL |
| BB4-7162-H2F0 | 5/16A. 380V. 45°EĞİK 2 ADET 3/16A. 220V. 45°EĞİK 2 ADET | 8 Sigorta Kap. | IP67 | 1    | 8.315,59 TL |

## 230x330x140

| Ürün Kodu     | Açıklama  | Sigorta Kap.   | IP   | Koli | Fiyat        |
|---------------|---|----------------|------|------|--------------|
| BB4-2192-8210 | 5/32A. 380V. 2 ADET 1/16A 220V. 2 ADET                                | 8 Sigorta Kap. | IP44 | 1    | 9.725,00 TL  |
| BB4-7190-0000 | PRİZSİZ ALÜMİNYUM KOMBİNASYON   | 8 Sigorta Kap. | IP67 | 1    | 9.550,00 TL  |
| BB4-7191-8210 | 5/32A. 380V. 1 ADET ÖN 1/16A. 220V. YAN 2 ADET                        | 8 Sigorta Kap. | IP67 | 1    | 10.559,23 TL |
| BB4-7192-8210 | 5/32A. 380V. 2 ADET 1/16A. 220V. 2 ADET                               | 8 Sigorta Kap. | IP67 | 1    | 11.172,73 TL |
| BB4-7192-8310 | 5/32A. 380V. 2 AD. 3/16A. 2 AD. 1/16A. 220V. 2 AD. (Sigorta Modülsüz) | -              | IP67 | 1    | 12.062,50 TL |
| BB4-7192-H210 | 5/16A. 380V. 45°EĞİK 2 ADET ÖN 1/16A. 220V. 2 ADET YAN                | 8 Sigorta Kap. | IP67 | 1    | 11.637,50 TL |
| BB4-7192-J210 | 5/32A. 380V. 45°EĞİK 2 ADET 1/16A. 220V. 2 ADET YAN                   | 8 Sigorta Kap. | IP67 | 1    | 12.362,50 TL |
| BB4M7192-8210 | 5/32A. 380V. 2 ADET 1/16A. 220V. 2 ADET KABLO BAĞLANTILI              | 8 Sigorta Kap. | IP67 | 1    | 12.362,50 TL |
| BB4M7192-J210 | 5/32A. 380V. 45°EĞİK 2 AD. 1/16A. 220V. 2 AD. KABLO BAĞLANTILI        | 8 Sigorta Kap. | IP67 | 1    | 12.787,50 TL |

## 310x400x140

| Ürün Kodu     | Açıklama   | Sigorta Kap.    | IP   | Koli | Fiyat        |
|---------------|--|-----------------|------|------|--------------|
| BB4-2184-8410 | 5/32A. 380V. 4 AD. 1/16A. 220V. 4 AD. (Sigorta Modülsüz)         | -               | IP44 | 1    | 11.500,00 TL |
| BB4-2182-8410 | 5/32A. 380V. 2 ADET 1/16A. 220V. 4 ADET                          | 12 Sigorta Kap. | IP44 | 1    | 12.815,00 TL |
| BB4-2182-8222 | 5/32A. 2 ADET 3/25A. 2 ADET ÖN 1/16A. 220V. 2 ADET YAN           | 12 Sigorta Kap. | IP44 | 1    | 13.141,26 TL |
| BB4-7180-0000 | PRİZSİZ ALÜMİNYUM KOMBİNASYON                                    | 12 Sigorta Kap. | IP67 | 1    | 10.000,00 TL |
| BB4-7181-8210 | 5/32A. 380V. 1 ADET 1/16A. 220V. 2 ADET                          | 12 Sigorta Kap. | IP67 | 1    | 12.150,00 TL |
| BB4-7182-7210 | 4/32A. 380V. 2 ADET 1/16A. 220V. 2 ADET                          | 8 Sigorta Kap.  | IP67 | 1    | 12.668,75 TL |
| BB4-7183-8000 | 5/32A. 380V. 3 ADET  | 12 Sigorta Kap. | IP67 | 1    | 13.375,00 TL |
| BB4-7182-8000 | 5/32A. 380V. 2 ADET  | 12 Sigorta Kap. | IP67 | 1    | 12.750,00 TL |
| BB4-7184-8210 | 5/32A. 380V. 4 ADET ÖN 1/16A. 220V. 2 ADET YAN                   | 12 Sigorta Kap. | IP67 | 1    | 14.862,50 TL |
| BB4-7182-8210 | 5/32A. 380V. 2 ADET 1/16A. 220V. 2 ADET                          | 12 Sigorta Kap. | IP67 | 1    | 13.625,00 TL |
| BB4-7182-J210 | 5/32A. 380V. 45°EĞİK 2 ADET 1/16A. 220V. 2 ADET                  | 12 Sigorta Kap. | IP67 | 1    | 13.687,50 TL |
| BB4-7182-8410 | 5/32A. 380V. 2 ADET 1/16A. 220V. 4 ADET                          | 12 Sigorta Kap. | IP67 | 1    | 14.500,00 TL |
| BB4-7181-B210 | 5/63A. 380V. 1 ADET 1/16A. 220V. 2 ADET                          | 12 Sigorta Kap. | IP67 | 1    | 13.525,00 TL |
| BB4M7182-8210 | 5/32A. 380V. 2 ADET 1/16A. 220V. 2 ADET KABLO BAĞLANTILI         | 12 Sigorta Kap. | IP67 | 1    | 14.062,50 TL |
| BB4M7182-J210 | 5/32A. 380V. 45°EĞİK 2 ADET 1/16A. 220V. 2 ADET KABLO BAĞLANTILI | 12 Sigorta Kap. | IP67 | 1    | 14.128,50 TL |
| BB4M7181-B210 | 5/63A. 380V. 1 ADET 1/16A. 220V. 2 ADET KABLO BAĞLANTILI         | 12 Sigorta Kap. | IP67 | 1    | 13.882,13 TL |

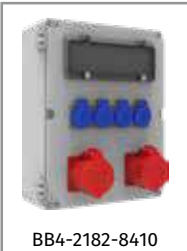

BB4-2182-8410



BB4-2184-8410



BB4-2192-8210



BB4-7182-8410



BB4-7162-H2F0



BB4-7183-8000



BB4-7191-8321



BB4-7192-J210



BB4-7192-8210

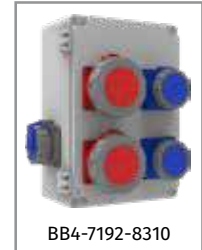

BB4-7192-8310

**450x600x350mm (Demonte Pano Ölçüsü)**

| Ürün Kodu     | Açıklama   | IP   | Kutu | Koli | Fiyat      |
|---------------|--|------|------|------|------------|
| BP3-2000-0000 | Boş şantiye panosu   | IP44 | 1    | 0    | FİYAT ALIN |
| BP3-2234-2188 | 5/32A. 380V. 2 Ad. - 5/16A. 380V. 2 Ad.-1/16A. 8 ad. P.P.  | IP44 | 1    | 0    | FİYAT ALIN |
| BP3-2249-2348 | 5/63A. 380V. 2 Ad. - 5/32A. 380V. 2 Ad.-1/16A. 8 Ad. P.P.  | IP44 | 1    | 0    | FİYAT ALIN |
| BP3-2255-2444 | 4/125A. 380V. 2 Ad. - 4/63A. 380V. 2 Ad.-1/16A. 4 Ad. P.P. | IP44 | 1    | 0    | FİYAT ALIN |
| BP3-2260-2454 | 5/125A. 380V. 2 Ad. - 5/63A. 380V. 2 Ad.-1/16A. 4 Ad. P.P. | IP44 | 1    | 0    | FİYAT ALIN |
| BP3-2418-8020 | 5/16A. 380V. 4 Ad. - 1/16A. 8 Ad. P.P.                     | IP44 | 1    | 0    | FİYAT ALIN |
| BP3-2434-8020 | 5/32A. 380V. 4 Ad. - 1/16A. 8 Ad. P.P.                     | IP44 | 1    | 0    | FİYAT ALIN |
| BP3-2444-8020 | 4/63A. 380V. 4 Ad. - 1/16A. 8 Ad. P.P.                     | IP44 | 1    | 0    | FİYAT ALIN |
| BP3-2449-8020 | 5/63A. 380V. 4 Ad. - 1/16A. 8 Ad. P.P.                     | IP44 | 1    | 0    | FİYAT ALIN |
| BP3-2805-8020 | 3/25A. 380V. 8 Ad. - 1/16A. 8 Ad. P.P.                     | IP44 | 1    | 0    | FİYAT ALIN |

Demonte Şantiye Panosu  
Tüm parçaları içerisinde



Sevkiyat'a Hazır Hali ve  
Ölçüleri: 450x600x350mm



Panolarımızın ana besleme  
girişi için alt kısımdan fırçalı  
ve geniş alan bırakılmıştır.

Müşterinin Montajını Yapmış Hali ve  
Ölçüleri: 550x900x420mm



Panolarımızın  
sabitlenme delikleri

Şantiye panolarında fiyatlara; otomat, kaçak akım ve kompakt şalterler **dahil değildir**.  
Temini müşteri tarafından sağlanması halinde montajı **ücretsiz** olarak yapılmaktadır.



550x900x420mm (16A. - 32A. Priz Montajlı Ölçüleri)  
700x900x420mm (63A. - 125A. Priz Montajlı Ölçüleri)

| Ürün Kodu     | Açıklama   | IP   | Kutu | Koli | Fiyat      |
|---------------|--|------|------|------|------------|
| BP3M2234-2188 | 5/32A. 380V. 2 Ad. - 5/16A. 380V. 2 Ad.-1/16A. 8 Ad. P.P.  | IP44 | 1    | 0    | FİYAT ALIN |
| BP3M2249-2348 | 5/63A. 380V. 2 Ad. - 5/32A. 380V. 2 Ad.-1/16A. 8 Ad. P.P.  | IP44 | 1    | 0    | FİYAT ALIN |
| BP3M2255-2444 | 4/125A. 380V. 2 Ad. - 4/63A. 380V. 2 Ad.-1/16A. 4 Ad. P.P. | IP44 | 1    | 0    | FİYAT ALIN |
| BP3M2260-2454 | 5/125A. 380V. 2 Ad. - 5/63A. 380V. 2 Ad.-1/16A. 4 Ad. P.P. | IP44 | 1    | 0    | FİYAT ALIN |
| BP3M2418-8020 | 5/16A. 380V. 4 Ad. - 1/16A. 8 Ad. P.P.                     | IP44 | 1    | 0    | FİYAT ALIN |
| BP3M2434-8020 | 5/32A. 380V. 4 Ad. - 1/16A. 8 Ad. P.P.                     | IP44 | 1    | 0    | FİYAT ALIN |
| BP3M2444-8020 | 4/63A. 380V. 4 Ad. - 1/16A. 8 Ad. P.P.                     | IP44 | 1    | 0    | FİYAT ALIN |
| BP3M2449-8020 | 5/63A. 380V. 4 Ad. - 1/16A. 8 Ad. P.P.                     | IP44 | 1    | 0    | FİYAT ALIN |
| BP3M2805-8020 | 3/25A. 380V. 8 Ad. - 1/16A. 8 Ad. P.P.                     | IP44 | 1    | 0    | FİYAT ALIN |

Fabrikada Tam Montajı Yapılmış  
Sevkiyat Hali

Fabrikada Tam Montajı Yapılmış  
Sevkiyat Hali

Fabrikada Priz Montajı Yapılmış  
Sevkiyat Hali

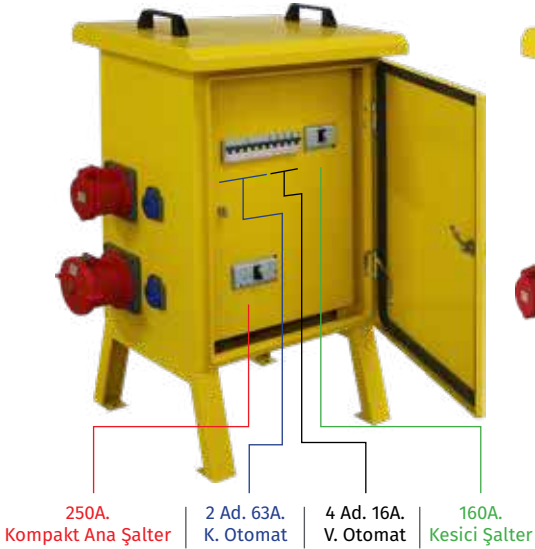

Kablo montajlı şantiye panolarında fiyatlara; otomat, kaçak akım ve kompakt şalterler **dahil değildir**.  
Temini müşteri tarafından sağlanması halinde montajı **ücretsiz** olarak yapılmaktadır.

**ABS. PANOLAR**

| Ürün Kodu     | Açıklama / Ölçü | IP   | Kutu | Koli | Fiyat       |
|---------------|-----------------|------|------|------|-------------|
| BPA-1001-0016 | 200x300x130 mm  | IP65 | 1    | 0    | 642,00 TL   |
| BPA-1101-0116 | 500X600X220 mm  | IP65 | 1    | 0    | 3.269,00 TL |
| BPA-2001-0026 | 250x350x150 mm  | IP65 | 1    | 0    | 924,00 TL   |
| BPA-3001-0036 | 300x400x170 mm  | IP65 | 1    | 0    | 1.257,00 TL |
| BPA-3001-0106 | 300x400x220 mm  | IP65 | 1    | 0    | 1.452,00 TL |
| BPA-4001-0046 | 350x500x190 mm  | IP65 | 1    | 0    | 1.736,00 TL |
| BPA-5001-0056 | 400x500x180 mm  | IP65 | 1    | 0    | 1.959,00 TL |
| BPA-6001-0066 | 400x500x240 mm  | IP65 | 1    | 0    | 2.254,00 TL |
| BPA-7001-0076 | 400x600x200 mm  | IP65 | 1    | 0    | 2.365,00 TL |
| BPA-8001-0086 | 500x700x250 mm  | IP65 | 1    | 0    | 3.949,00 TL |
| BPA-9001-0096 | 600x800x260 mm  | IP65 | 1    | 0    | 5.786,00 TL |

*Opak Kapak ABS Panolar*

| Ürün Kodu     | Açıklama / Ölçü | IP   | Kutu | Koli | Fiyat       |
|---------------|-----------------|------|------|------|-------------|
| BPC-1001-0016 | 200x300x130 mm  | IP65 | 1    | 0    | 848,00 TL   |
| BPC-1101-0116 | 500X600X220 mm  | IP65 | 1    | 0    | 4.213,00 TL |
| BPC-2001-0026 | 250x350x150 mm  | IP65 | 1    | 0    | 1.232,00 TL |
| BPC-3001-0036 | 300x400x170 mm  | IP65 | 1    | 0    | 1.670,00 TL |
| BPC-3001-0106 | 300x400x220 mm  | IP65 | 1    | 0    | 1.895,00 TL |
| BPC-4001-0046 | 350x500x190 mm  | IP65 | 1    | 0    | 2.281,00 TL |
| BPC-5001-0056 | 400x500x180 mm  | IP65 | 1    | 0    | 2.545,00 TL |
| BPC-6001-0066 | 400x500x240 mm  | IP65 | 1    | 0    | 2.969,00 TL |
| BPC-7001-0076 | 400x600x200 mm  | IP65 | 1    | 0    | 3.101,00 TL |
| BPC-8001-0086 | 500x700x250 mm  | IP65 | 1    | 0    | 5.113,00 TL |
| BPC-9001-0096 | 600x800x260 mm  | IP65 | 1    | 0    | 7.418,00 TL |

*Şeffaf Kapak ABS Panolar*

Şeffaf Kapak ABS Pano

- 650°C dayanıklı yanmaz gövde
- Halogen free

**IK 10  
IP 65**5 YIL  
GARANTİ

CE













YERLİ  
ÜRETİM

Opak Kapak ABS Pano



| Ürün Kodu     | Açıklama       | Ürün Ölçüsü (mm) | IP   | Kutu | Koli | Fiyat       |
|---------------|----------------|------------------|------|------|------|-------------|
| BB1-0141-0003 | Geçme Kapak    | Çap Ø70          | IP44 | 27   | 216  | 81,00 TL    |
| BB1-0241-0003 | Geçme Kapak    | Çap Ø90          | IP44 | 20   | 160  | 90,00 TL    |
| BB1-0341-0003 | Geçme Kapak    | 85x85x50         | IP44 | 75   | 0    | 99,00 TL    |
| BB1-0431-0083 | Vidalı Kapak   | 95x95x60         | IP44 | 8    | 64   | 116,00 TL   |
| BB1-0441-0003 | Geçme Kapak    | 95x95x50         | IP44 | 8    | 96   | 110,00 TL   |
| BB1-0521-0063 | Şeffaf Kapaklı | 120x120x140      | IP44 | 1    | 60   | 323,00 TL   |
| BB1-0531-0003 | Vidalı Kapak   | 120x120x70       | IP44 | 6    | 48   | 192,00 TL   |
| BB1-0531-0063 | Vidalı Kapak   | 120x120x140      | IP44 | 1    | 60   | 274,00 TL   |
| BB1-0621-0063 | Şeffaf Kapaklı | 120x224x140      | IP44 | 1    | 30   | 520,00 TL   |
| BB1-0631-0003 | Vidalı Kapak   | 120x255x80       | IP44 | 10   | 0    | 328,00 TL   |
| BB1-0631-0063 | Vidalı Kapak   | 120x224x140      | IP44 | 1    | 30   | 462,00 TL   |
| BB1-0721-0063 | Şeffaf Kapaklı | 220x300x140      | IP44 | 1    | 10   | 852,00 TL   |
| BB1-0731-0003 | Vidalı Kapak   | 210x300x90       | IP44 | 4    | 0    | 601,00 TL   |
| BB1-0731-0063 | Vidalı Kapak   | 220x300x140      | IP44 | 1    | 10   | 803,00 TL   |
| BB1-0921-0023 | Şeffaf Kapaklı | 120x170x70       | IP44 | 15   | 0    | 383,00 TL   |
| BB1-0921-0063 | Şeffaf Kapaklı | 120x170x140      | IP44 | 1    | 40   | 415,00 TL   |
| BB1-0931-0023 | Vidalı Kapak   | 120x170x70       | IP44 | 15   | 20   | 335,00 TL   |
| BB1-0931-0063 | Vidalı Kapak   | 120x170x140      | IP44 | 1    | 40   | 361,00 TL   |
| BB1-1021-0073 | Şeffaf Kapaklı | 340x340x160      | IP44 | 1    | 6    | 2.166,00 TL |
| BB1-1031-0073 | Vidalı Kapak   | 340x340x160      | IP44 | 1    | 6    | 2.022,00 TL |
| BB1-1121-0053 | Şeffaf Kapaklı | 110x110x100      | IP44 | 4    | 48   | 203,00 TL   |
| BB1-1131-0053 | Vidalı Kapak   | 110x110x100      | IP44 | 4    | 48   | 159,00 TL   |
| BB1-1221-0092 | Şeffaf Kapaklı | 300x535x150      | IP44 | 2    | 0    | 2.744,00 TL |
| BB1-1231-0023 | Vidalı Kapak   | 110x110x70       | IP44 | 6    | 48   | 149,00 TL   |
| BB1-1231-0092 | Vidalı Kapak   | 300x535x150      | IP44 | 2    | 0    | 2.455,00 TL |
| BB1-1331-0023 | Vidalı Kapak   | 110x150x70       | IP44 | 4    | 32   | 172,00 TL   |
| BB1-1631-0023 | Vidalı Kapak   | 110x180x70       | IP44 | 4    | 32   | 250,88 TL   |
| BB1-1531-0063 | Vidalı Kapak   | 200x500x140      | IP44 | 1    | 4    | 1.451,00 TL |
| BB1-1521-0063 | Şeffaf Kapak   | 200x500x140      | IP44 | 1    | 4    | 1.565,00 TL |

yeni  
yeni  
yeni

|  |  |   |  |  |   |
|--|--|---|--|--|---|
| <p>70 mm</p>  <p>BB2-0141-0003<br/>Halogen Free IP44<br/>BB1-0141-0003</p>  | <p>90 mm</p>  <p>BB2-0241-0003<br/>Halogen Free IP44<br/>BB1-0241-0003</p>  | <p>85x85x50</p>  <p>BB2-0341-0003<br/>Halogen Free IP44<br/>BB1-0341-0003</p>  | <p>95x95x50</p>  <p>BB2-0441-0003<br/>Halogen Free IP44<br/>BB1-0441-0003</p>   | <p>95x95x60</p>  <p>BB2-0431-0083 / IP44<br/>BB2-0431-0086 / IP67<br/>Halogen Free<br/>BB1-0431-0083 / IP44<br/>BB1-0431-0086 / IP67</p>    | <p>110x110x70</p>  <p>BB2-1231-0023 / IP44<br/>BB2-1231-0026 / IP67<br/>Halogen Free<br/>BB1-1231-0023 / IP44<br/>BB1-1231-0026 / IP67</p> |
| <p>110x110x100</p>  <p>BB2-1131-0053 / IP44<br/>BB2-1131-0056 / IP67<br/>Halogen Free<br/>BB1-1131-0053 / IP44<br/>BB1-1131-0056 / IP67</p> | <p>110x110x100</p>  <p>BB2-1121-0053 / IP44<br/>BB2-1121-0056 / IP67<br/>Halogen Free<br/>BB1-1121-0053 / IP44<br/>BB1-1121-0056 / IP67</p> | <p>120x120x70</p>  <p>BB2-0531-0003 / IP44<br/>BB2-0531-0006 / IP67<br/>Halogen Free<br/>BB1-0531-0003 / IP44<br/>BB1-0531-0006 / IP67</p> | <p>120x120x140</p>  <p>BB2-0531-0063 / IP44<br/>BB2-0531-0066 / IP67<br/>Halogen Free<br/>BB1-0531-0063 / IP44<br/>BB1-0531-0066 / IP67</p> | <p>120x120x140</p>  <p>BB2-0521-0063 / IP44<br/>BB2-0521-0066 / IP67<br/>Halogen Free<br/>BB1-0521-0063 / IP44<br/>BB1-0521-0066 / IP67</p> | <p>110x150x70</p>  <p>BB2-1331-0023 / IP44<br/>BB2-1331-0026 / IP67<br/>Halogen Free<br/>BB1-1331-0023 / IP44<br/>BB1-1331-0026 / IP67</p> |

# ABS Plastik Buat IP44



| Ürün Kodu     | Açıklama       | Ürün Ölçüsü (mm) | IP   | Kutu | Koli | Fiyat       |
|---------------|----------------|------------------|------|------|------|-------------|
| BB2-0141-0003 | Geçme Kapak    | Çap Ø70          | IP44 | 27   | 216  | 60,00 TL    |
| BB2-0241-0003 | Geçme Kapak    | Çap Ø90          | IP44 | 20   | 160  | 60,00 TL    |
| BB2-0341-0003 | Geçme Kapak    | 85x85x50         | IP44 | 75   | 0    | 70,00 TL    |
| BB2-0431-0083 | Vidalı Kapak   | 95x95x60         | IP44 | 8    | 64   | 81,00 TL    |
| BB2-0441-0003 | Geçme Kapak    | 95x95x50         | IP44 | 8    | 96   | 85,00 TL    |
| BB2-0521-0063 | Şeffaf Kapaklı | 120x120x140      | IP44 | 1    | 60   | 269,00 TL   |
| BB2-0531-0003 | Vidalı Kapak   | 120x120x70       | IP44 | 6    | 48   | 158,00 TL   |
| BB2-0531-0063 | Vidalı Kapak   | 120x120x140      | IP44 | 1    | 60   | 234,00 TL   |
| BB2-0621-0063 | Şeffaf Kapaklı | 120x224x140      | IP44 | 1    | 30   | 426,00 TL   |
| BB2-0631-0003 | Vidalı Kapak   | 120x255x80       | IP44 | 10   | 0    | 254,00 TL   |
| BB2-0631-0063 | Vidalı Kapak   | 120x224x140      | IP44 | 1    | 30   | 366,00 TL   |
| BB2-0721-0063 | Şeffaf Kapaklı | 220x300x140      | IP44 | 1    | 10   | 741,00 TL   |
| BB2-0731-0003 | Vidalı Kapak   | 210x300x90       | IP44 | 4    | 0    | 487,00 TL   |
| BB2-0731-0063 | Vidalı Kapak   | 220x300x140      | IP44 | 1    | 10   | 619,00 TL   |
| BB2-0921-0023 | Şeffaf Kapaklı | 120x170x70       | IP44 | 15   | 0    | 238,00 TL   |
| BB2-0921-0063 | Şeffaf Kapaklı | 120x170x140      | IP44 | 1    | 40   | 335,00 TL   |
| BB2-0931-0023 | Vidalı Kapak   | 120x170x70       | IP44 | 15   | 0    | 219,00 TL   |
| BB2-0931-0063 | Vidalı Kapak   | 120x170x140      | IP44 | 1    | 40   | 304,00 TL   |
| BB2-1021-0073 | Şeffaf Kapaklı | 340x340x160      | IP44 | 1    | 6    | 1.684,00 TL |
| BB2-1031-0073 | Vidalı Kapak   | 340x340x160      | IP44 | 1    | 6    | 1.420,00 TL |
| BB2-1121-0053 | Şeffaf Kapaklı | 110x110x100      | IP44 | 4    | 48   | 161,00 TL   |
| BB2-1131-0053 | Vidalı Kapak   | 110x110x100      | IP44 | 4    | 48   | 132,00 TL   |
| BB2-1221-0092 | Şeffaf Kapaklı | 300x535x150      | IP44 | 2    | 0    | 2.232,00 TL |
| BB2-1231-0023 | Vidalı Kapak   | 110x110x70       | IP44 | 6    | 48   | 129,00 TL   |
| BB2-1231-0092 | Vidalı Kapak   | 300x535x150      | IP44 | 2    | 0    | 1.927,00 TL |
| BB2-1331-0023 | Vidalı Kapak   | 110x150x70       | IP44 | 4    | 32   | 147,00 TL   |
| BB2-1631-0023 | Vidalı Kapak   | 110x180x70       | IP44 | 4    | 32   | 205,64 TL   |
| BB2-1531-0063 | Vidalı Kapak   | 200x500x140      | IP44 | 1    | 4    | 1.161,00 TL |
| BB2-1521-0063 | Şeffaf Kapak   | 200x500x140      | IP44 | 1    | 4    | 1.252,00 TL |

yeni  
yeni  
yeni

Buat ve Pano  
Kutuları

|   |   |  |   |   |  |
|---|---|--|---|---|--|
| <p>110x180x70</p>  <p>BB2-1631-0023 / IP44<br/>BB2-1631-0026 / IP67</p> <p>Halogen Free<br/>BB1-1631-0023 / IP44<br/>BB1-1631-0026 / IP67</p>  | <p>120x170x70</p>  <p>BB2-0931-0023 / IP44<br/>BB2-0931-0026 / IP67</p> <p>Halogen Free<br/>BB1-0931-0023 / IP44<br/>BB1-0931-0026 / IP67</p>  | <p>120x170x70</p>  <p>BB2-0921-0023 / IP44<br/>BB2-0921-0026 / IP67</p> <p>Halogen Free<br/>BB1-0921-0023 / IP44<br/>BB1-0921-0026 / IP67</p> | <p>120x170x140</p>  <p>BB2-0931-0063 / IP44<br/>BB2-0931-0066 / IP67</p> <p>Halogen Free<br/>BB1-0931-0063 / IP44<br/>BB1-0931-0066 / IP67</p> | <p>120x170x140</p>  <p>BB2-0921-0063 / IP44<br/>BB2-0921-0066 / IP67</p> <p>Halogen Free<br/>BB1-0921-0063 / IP44<br/>BB1-0921-0066 / IP67</p> | <p>120x255x80</p>  <p>BB2-0631-0003 / IP44<br/>BB2-0631-0006 / IP67</p> <p>Halogen Free<br/>BB1-0631-0003 / IP44<br/>BB1-0631-0006 / IP67</p> |
| <p>120x225x140</p>  <p>BB2-0631-0063 / IP44<br/>BB2-0631-0066 / IP67</p> <p>Halogen Free<br/>BB1-0631-0063 / IP44<br/>BB1-0631-0066 / IP67</p> | <p>120x224x140</p>  <p>BB2-0621-0063 / IP44<br/>BB2-0621-0066 / IP67</p> <p>Halogen Free<br/>BB1-0621-0063 / IP44<br/>BB1-0621-0066 / IP67</p> | <p>210x300x90</p>  <p>BB2-0731-0003 / IP44<br/>BB2-0731-0006 / IP67</p> <p>Halogen Free<br/>BB1-0731-0003 / IP44<br/>BB1-0731-0006 / IP67</p> | <p>220x300x140</p>  <p>BB2-0731-0063 / IP44<br/>BB2-0731-0066 / IP67</p> <p>Halogen Free<br/>BB1-0731-0063 / IP44<br/>BB1-0731-0066 / IP67</p> | <p>220x300x140</p>  <p>BB2-0721-0063 / IP44<br/>BB2-0721-0066 / IP67</p> <p>Halogen Free<br/>BB1-0721-0063 / IP44<br/>BB1-0721-0066 / IP67</p> |  |

| Ürün Kodu          | Açıklama       | Ürün Ölçüsü (mm) | IP   | Kutu | Koli | Fiyat       |
|--------------------|----------------|------------------|------|------|------|-------------|
| BB1-0431-0086      | Vidalı Kapak   | 95x95x60         | IP67 | 8    | 64   | 174,00 TL   |
| BB1-0521-0066      | Şeffaf Kapaklı | 120x120x140      | IP67 | 1    | 60   | 419,00 TL   |
| BB1-0531-0006      | Vidalı Kapak   | 120x120x70       | IP67 | 6    | 48   | 260,00 TL   |
| BB1-0531-0066      | Vidalı Kapak   | 120x120x140      | IP67 | 1    | 60   | 347,00 TL   |
| BB1-0621-0066      | Şeffaf Kapaklı | 120x224x140      | IP67 | 1    | 30   | 693,00 TL   |
| BB1-0631-0006      | Vidalı Kapak   | 120x255x80       | IP67 | 10   | 0    | 434,00 TL   |
| BB1-0631-0066      | Vidalı Kapak   | 120x224x140      | IP67 | 1    | 30   | 578,00 TL   |
| BB1-0721-0066      | Şeffaf Kapaklı | 220x300x140      | IP67 | 1    | 10   | 1.155,00 TL |
| BB1-0731-0006      | Vidalı Kapak   | 210x300x90       | IP67 | 4    | 0    | 809,00 TL   |
| BB1-0731-0066      | Vidalı Kapak   | 220x300x140      | IP67 | 1    | 10   | 1.011,00 TL |
| BB1-0921-0026      | Şeffaf Kapaklı | 120x170x70       | IP67 | 15   | 0    | 462,00 TL   |
| BB1-0921-0066      | Şeffaf Kapaklı | 120x170x140      | IP67 | 1    | 40   | 565,00 TL   |
| BB1-0931-0026      | Vidalı Kapak   | 120x170x70       | IP67 | 15   | 0    | 370,00 TL   |
| BB1-0931-0066      | Vidalı Kapak   | 120x170x140      | IP67 | 1    | 40   | 502,00 TL   |
| BB1-1021-0076      | Şeffaf Kapaklı | 340x340x160      | IP67 | 1    | 6    | 2.541,00 TL |
| BB1-1031-0076      | Vidalı Kapak   | 340x340x160      | IP67 | 1    | 6    | 2.310,00 TL |
| BB1-1121-0056      | Şeffaf Kapaklı | 110x110x100      | IP67 | 4    | 48   | 260,00 TL   |
| BB1-1131-0056      | Vidalı Kapak   | 110x110x100      | IP67 | 4    | 48   | 217,00 TL   |
| BB1-1221-0096      | Şeffaf Kapaklı | 300x535x150      | IP67 | 2    | 0    | 3.177,00 TL |
| BB1-1231-0026      | Vidalı Kapak   | 110x110x70       | IP67 | 6    | 48   | 188,00 TL   |
| BB1-1231-0096      | Vidalı Kapak   | 300x535x150      | IP67 | 2    | 0    | 3.032,00 TL |
| BB1-1331-0026      | Vidalı Kapak   | 110x150x70       | IP67 | 4    | 32   | 229,00 TL   |
| BB1-1431-0006      | Vidalı Kapak   | Çap Ø80x45       | IP67 | 16   | 128  | 93,00 TL    |
| yeni BB1-1631-0026 | Vidalı Kapak   | 110x180x70       | IP67 | 4    | 32   | 302,00 TL   |
| yeni BB1-1531-0066 | Vidalı Kapak   | 200x500x140      | IP67 | 1    | 4    | 1.816,00 TL |
| yeni BB1-1521-0066 | Şeffaf Kapak   | 200x500x140      | IP67 | 1    | 4    | 1.930,00 TL |

Ø80x45mm.  
Vidalı Kapak



Halogen Free  
BB1-1431-0006 / IP67

340x340x160



Halogen Free  
BB1-1031-0073 / IP44  
BB1-1031-0076 / IP67

340x340x160



Halogen Free  
BB1-1021-0073 / IP44  
BB1-1021-0076 / IP67

300x535x150



Halogen Free  
BB1-1231-0092 / IP44  
BB1-1231-0096 / IP67

300x535x150

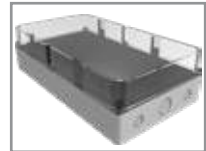

Halogen Free  
BB1-1221-0092 / IP44  
BB1-1221-0096 / IP67

200x500x140



Halogen Free  
BB1-1531-0063 / IP44  
BB1-1531-0066 / IP67

200x500x140

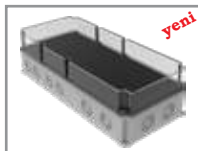

Halogen Free  
BB1-1521-0063 / IP44  
BB1-1521-0066 / IP67

| Ürün Kodu          | Açıklama       | Ürün Ölçüsü (mm) | IP   | Kutu | Koli | Fiyat       |
|--------------------|----------------|------------------|------|------|------|-------------|
| BB2-0431-0086      | Vidalı Kapak   | 95x95x60         | IP67 | 8    | 64   | 110,00 TL   |
| BB2-0521-0066      | Şeffaf Kapaklı | 120x120x140      | IP67 | 1    | 60   | 336,00 TL   |
| BB2-0531-0006      | Vidalı Kapak   | 120x120x70       | IP67 | 6    | 48   | 204,00 TL   |
| BB2-0531-0066      | Vidalı Kapak   | 120x120x140      | IP67 | 1    | 60   | 282,00 TL   |
| BB2-0621-0066      | Şeffaf Kapaklı | 120x224x140      | IP67 | 1    | 30   | 490,00 TL   |
| BB2-0631-0006      | Vidalı Kapak   | 120x255x80       | IP67 | 10   | 0    | 349,00 TL   |
| BB2-0631-0066      | Vidalı Kapak   | 120x224x140      | IP67 | 1    | 30   | 421,00 TL   |
| BB2-0721-0066      | Şeffaf Kapaklı | 220x300x140      | IP67 | 1    | 10   | 816,00 TL   |
| BB2-0731-0006      | Vidalı Kapak   | 210x300x90       | IP67 | 4    | 0    | 565,00 TL   |
| BB2-0731-0066      | Vidalı Kapak   | 220x300x140      | IP67 | 1    | 10   | 706,00 TL   |
| BB2-0921-0026      | Şeffaf Kapaklı | 120x170x70       | IP67 | 15   | 0    | 300,00 TL   |
| BB2-0921-0066      | Şeffaf Kapaklı | 120x170x140      | IP67 | 1    | 40   | 416,00 TL   |
| BB2-0931-0026      | Vidalı Kapak   | 120x170x70       | IP67 | 15   | 0    | 240,00 TL   |
| BB2-0931-0066      | Vidalı Kapak   | 120x170x140      | IP67 | 1    | 40   | 376,00 TL   |
| BB2-1021-0076      | Şeffaf Kapaklı | 340x340x160      | IP67 | 1    | 6    | 2.065,00 TL |
| BB2-1031-0076      | Vidalı Kapak   | 340x340x160      | IP67 | 1    | 6    | 1.931,00 TL |
| BB2-1121-0056      | Şeffaf Kapaklı | 110x110x100      | IP67 | 4    | 48   | 226,00 TL   |
| BB2-1131-0056      | Vidalı Kapak   | 110x110x100      | IP67 | 4    | 48   | 194,00 TL   |
| BB2-1221-0096      | Şeffaf Kapaklı | 300x535x150      | IP67 | 2    | 0    | 2.735,00 TL |
| BB2-1231-0026      | Vidalı Kapak   | 110x110x70       | IP67 | 6    | 48   | 141,00 TL   |
| BB2-1231-0096      | Vidalı Kapak   | 300x535x150      | IP67 | 2    | 0    | 2.434,00 TL |
| BB2-1331-0026      | Vidalı Kapak   | 110x150x70       | IP67 | 4    | 32   | 198,00 TL   |
| BB2-1431-0006      | Vidalı Kapak   | Çap Ø80x45       | IP67 | 16   | 128  | 80,00 TL    |
| yeni BB2-1631-0026 | Vidalı Kapak   | 110x180x70       | IP67 | 4    | 32   | 251,74 TL   |
| yeni BB2-1531-0066 | Vidalı Kapak   | 200x500x140      | IP67 | 1    | 4    | 1.453,00 TL |
| yeni BB2-1521-0066 | Şeffaf Kapak   | 200x500x140      | IP67 | 1    | 4    | 1.544,00 TL |

Ø80x45mm.  
Vidalı Kapak



BB2-1431-0006 / IP67

340x340x160



BB2-1031-0073 / IP44  
BB2-1031-0076 / IP67

340x340x160



BB2-1021-0073 / IP44  
BB2-1021-0076 / IP67

300x535x150



BB2-1231-0092 / IP44  
BB2-1231-0096 / IP67

300x535x150

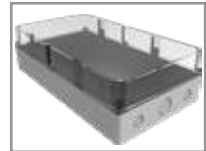

BB2-1221-0092 / IP44  
BB2-1221-0096 / IP67

200x500x140

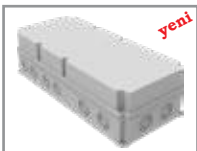

Halogen Free  
BB2-1531-0063 / IP44  
BB2-1531-0066 / IP67

200x500x140

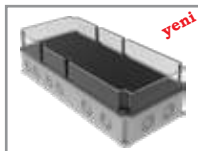

Halogen Free  
BB2-1521-0063 / IP44  
BB2-1521-0066 / IP67

| Ürün Kodu     | Ürün Ölçüleri (mm)      | IP   | Kutu | Koli | Fiyat       |
|---------------|-------------------------|------|------|------|-------------|
| BB3-2103-1017 | 65x65x40                | IP67 | 1    | 16   | 390,00 TL   |
| BB3-2113-1017 | 65x100x40               | IP67 | 1    | 10   | 491,00 TL   |
| BB3-2123-1107 | 100x130x75              | IP67 | 1    | 24   | 878,00 TL   |
| BB3-2131-0087 | 80x80x60                | IP67 | 1    | 65   | 590,00 TL   |
| BB3-2131-0097 | 80x80x73                | IP67 | 1    | 45   | 687,00 TL   |
| BB3-2531-0407 | 100x100x90              | IP67 | 1    | 28   | 788,00 TL   |
| BB3-2133-1047 | 130x230x90              | IP67 | 1    | 9    | 2.224,00 TL |
| BB3-2143-1047 | 160x160x90              | IP67 | 1    | 12   | 1.935,00 TL |
| BB3-2153-1047 | 160x260x90              | IP67 | 1    | 7    | 3.867,00 TL |
| BB3-2150-1047 | 160x260x90 (Menteşeli)  | IP67 | 1    | 7    | 4.340,00 TL |
| BB3-2160-1047 | 190x350x90 (Menteşeli)  | IP67 | 1    | 3    | 5.184,00 TL |
| BB3-2163-1047 | 190x350x90              | IP67 | 1    | 3    | 4.724,00 TL |
| BB3-2170-1057 | 250x250x110 (Menteşeli) | IP67 | 1    | 4    | 5.054,00 TL |
| BB3-2173-1057 | 250x250x110             | IP67 | 1    | 4    | 4.612,00 TL |
| BB3-2180-1067 | 310x400x140 (Menteşeli) | IP67 | 1    | 2    | 8.158,00 TL |
| BB3-2183-1067 | 310x400x140             | IP67 | 1    | 2    | 7.623,00 TL |
| BB3-2190-1067 | 230x330x140 (Menteşeli) | IP67 | 1    | 1    | 7.378,00 TL |
| BB3-2193-1067 | 230x330x140             | IP67 | 1    | 1    | 6.627,00 TL |
| BB3-2231-0097 | 80x130x73               | IP67 | 1    | 35   | 852,00 TL   |
| BB3-2331-0097 | 80x170x73               | IP67 | 1    | 22   | 966,00 TL   |
| BB3-2431-0097 | 80x230x73               | IP67 | 1    | 15   | 1.490,00 TL |
| BB3-2531-0107 | 100x100x75              | IP67 | 1    | 30   | 720,00 TL   |
| BB3-2631-0047 | 130x130x90              | IP67 | 1    | 18   | 1.528,00 TL |
| BB3-2731-0047 | 130x190x90              | IP67 | 1    | 12   | 1.848,00 TL |
| BB3-2831-0047 | 170x190x90              | IP67 | 1    | 1    | 2.253,00 TL |
| BB3-2931-0047 | 190x250x90              | IP67 | 1    | 1    | 3.800,00 TL |

65x65x40



BB3-2103-1017

65x100x40



BB3-2113-1017

80x80x60



BB3-2131-0087

80x80x73



BB3-2131-0097

80x130x73

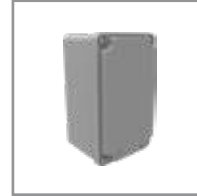

BB3-2231-0097

80x170x73



BB3-2331-0097

80x230x73



BB3-2431-0097

100x100x75



BB3-2531-0107

100x130x75



BB3-2123-1107

130x130x90



BB3-2631-0047

130x190x90

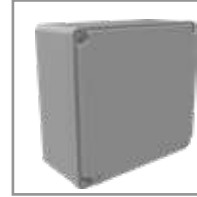

BB3-2731-0047

130x230x90



BB3-2133-1047

160x160x90



BB3-2143-1047

160x260x90



BB3-2153-1047

170x190x90



BB3-2831-0047

190x250x90



BB3-2931-0047

190x350x90



BB3-2163-1047

190x350x90 (Menteşeli)



BB3-2160-1047

250x250x110



BB3-2173-1057

250x250x110 (Menteşeli)



BB3-2170-1057

310x400x140



BB3-2183-1067

310x400x140 (Menteşeli)



BB3-2180-1067

230x330x140



BB3-2193-1067

230x330x140 (Menteşeli)



BB3-2190-1067



100  
yüzde  
yerli...

**B** bemis

5 YIL  
GARANTİ

**Buton ve Şalter Kutuları**  
Alüminyum - Plastik

**YERLİ  
ÜRETİM**

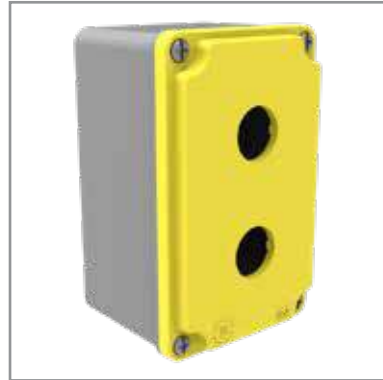
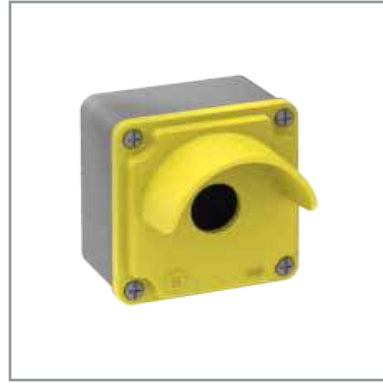

Buton-Şalter  
Kutuları

Üreten Ülke Güçlüdür

| Ürün Kodu     | Açıklama                      | IP   | Kutu | Koli | Fiyat     |
|---------------|-------------------------------|------|------|------|-----------|
| BT3-1000-0002 | 1'li Buton Kutusu (Siyah)     | IP44 | 16   | 128  | 80,00 TL  |
| BT3-1011-0002 | Acil Stop Buton Kutusu (Sarı) | IP44 | 16   | 128  | 85,00 TL  |
| BT3-2000-0002 | 2'li Buton Kutusu (Siyah)     | IP44 | 12   | 96   | 110,00 TL |
| BT3-3000-0002 | 3'lü Buton Kutusu (Siyah)     | IP44 | 8    | 64   | 135,00 TL |
| BT3-4000-0002 | 4'lü Buton Kutusu (Siyah)     | IP44 | 6    | 48   | 160,00 TL |
| BT3-5000-0002 | 5'li Buton Kutusu (Siyah)     | IP44 | 6    | 48   | 184,00 TL |

Acil Stop Buton Kutusu



BT3-1011-0002

Tekli Buton Kutusu



BT3-1000-0002

İkili Buton Kutusu



BT3-2000-0002

Üçlü Buton Kutusu



BT3-3000-0002

Dörtlü Buton Kutusu



BT3-4000-0002

Beşli Buton Kutusu



BT3-5000-0002

| Ürün Kodu     | Açıklama                      | IP   | Kutu | Koli | Fiyat     |
|---------------|-------------------------------|------|------|------|-----------|
| BT3-1000-0006 | 1'li Buton Kutusu (Siyah)     | IP67 | 16   | 128  | 141,00 TL |
| BT3-1011-0006 | Acil Stop Buton Kutusu (Sarı) | IP67 | 16   | 128  | 150,00 TL |
| BT3-2000-0006 | 2'li Buton Kutusu (Siyah)     | IP67 | 12   | 96   | 161,00 TL |
| BT3-3000-0006 | 3'lü Buton Kutusu (Siyah)     | IP67 | 8    | 64   | 188,00 TL |
| BT3-4000-0006 | 4'lü Buton Kutusu (Siyah)     | IP67 | 6    | 48   | 228,00 TL |
| BT3-5000-0006 | 5'li Buton Kutusu (Siyah)     | IP67 | 6    | 48   | 251,00 TL |

Acil Stop Buton Kutusu



BT3-1011-0006

Tekli Buton Kutusu



BT3-1000-0006

İkili Buton Kutusu



BT3-2000-0006

Üçlü Buton Kutusu



BT3-3000-0006

Dörtlü Buton Kutusu



BT3-4000-0006

Beşli Buton Kutusu



BT3-5000-0006

| Ürün Kodu     | Açıklama                                    | IP   | Kutu | Koli | Fiyat     |
|---------------|---|------|------|------|-----------|
| BT3-1020-0002 | 10A. Pako Şalter Kutusu                     | IP44 | 16   | 128  | 113,00 TL |
| BT3-2030-0002 | 25A. Pako Şalter Kutusu                     | IP44 | 12   | 96   | 150,00 TL |
| BT3-4040-0002 | Sigorta ve Priz Kutusu                      | IP44 | 6    | 48   | 234,00 TL |
| BT3-4050-0002 | 1/16A. 220V. Prizli Sigorta Kutusu          | IP44 | 6    | 48   | 338,00 TL |
| BT3-4060-0002 | 1/16A. 220V. Prizli Sinyalli Sigorta Kutusu | IP44 | 6    | 48   | 394,00 TL |

10A. Pako Şalter Kutusu



BT3-1020-0002

25A. Pako Şalter Kutusu



BT3-2030-0002

Priz ve Sigorta Kutusu

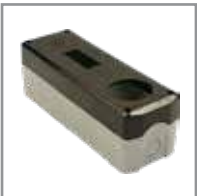

BT3-4040-0002

1/16A. 220V. Prizli Sigorta Kutusu



BT3-4050-0002

1/16A. 220V. Prizli Sinyalli Sigorta Kutusu



BT3-4060-0002

# Alüminyum Buton Kutuları



| Ürün Kodu     | Açıklama          | Ürün Ölçüleri | IP   | Kutu | Koli | Fiyat       |
|---------------|-------------------|---------------|------|------|------|-------------|
| BT4-1001-0007 | 1'li Buton Kutusu | 80x80x60      | IP67 | 1    | 65   | 750,00 TL   |
| BT4-1001-0017 | 1'li Buton Kutusu | 80x80x73      | IP67 | 1    | 45   | 786,00 TL   |
| BT4-2001-0007 | 2'li Buton Kutusu | 80x130x73     | IP67 | 1    | 35   | 985,00 TL   |
| BT4-3001-0007 | 3'lü Buton Kutusu | 80x170x73     | IP67 | 1    | 22   | 1.150,00 TL |
| BT4-3001-0017 | 4'lü Buton Kutusu | 80x170x73     | IP67 | 1    | 22   | 1.190,00 TL |
| BT4-4001-0007 | 5'li Buton Kutusu | 80x230x73     | IP67 | 1    | 15   | 1.550,00 TL |
| BT4-4001-0017 | 6'li Buton Kutusu | 80x230x73     | IP67 | 1    | 15   | 1.700,00 TL |

Tekli Buton Kutusu  
80x80x60



BT4-1001-0007

Tekli Buton Kutusu  
80x80x73



BT4-1001-0017

İkili Buton Kutusu  
80x130x73

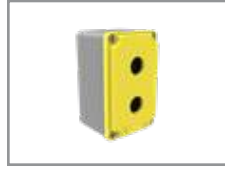

BT4-2001-0007

Üçlü Buton Kutusu  
80x170x73

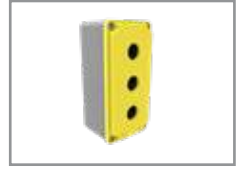

BT4-3001-0007

Dörtlü Buton Kutusu  
80x170x73

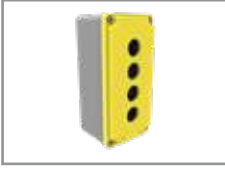

BT4-3001-0017

Beşli Buton Kutusu  
80x230x73



BT4-4001-0007

Altılı Buton Kutusu  
80x230x73



BT4-4001-0017

| Ürün Kodu     | Açıklama                   | Ürün Ölçüleri | IP   | Kutu | Koli | Fiyat       |
|---------------|----------------------------|---------------|------|------|------|-------------|
| BT4-1071-0007 | 1'li Korumalı Buton Kutusu | 80x80x60      | IP67 | 1    | 65   | 950,00 TL   |
| BT4-1071-0017 | 1'li Korumalı Buton Kutusu | 80x80x73      | IP67 | 1    | 45   | 956,00 TL   |
| BT4-2071-0007 | 2'li Korumalı Buton Kutusu | 80x130x73     | IP67 | 1    | 35   | 1.203,00 TL |
| BT4-3071-0007 | 3'lü Korumalı Buton Kutusu | 80x170x73     | IP67 | 1    | 22   | 1.415,00 TL |
| BT4-3071-0017 | 4'lü Korumalı Buton Kutusu | 80x170x73     | IP67 | 1    | 22   | 1.490,00 TL |
| BT4-4071-0007 | 5'li Korumalı Buton Kutusu | 80x230x73     | IP67 | 1    | 15   | 1.840,00 TL |
| BT4-4071-0017 | 6'li Korumalı Buton Kutusu | 80x230x73     | IP67 | 1    | 15   | 1.940,00 TL |

Tekli Buton Kutusu  
Korumalı  
80x80x60



BT4-1071-0007

Tekli Buton Kutusu  
Korumalı  
80x80x73



BT4-1071-0017

İkili Buton Kutusu  
Korumalı  
80x130x73



BT4-2071-0007

Üçlü Buton Kutusu  
Korumalı  
80x170x73



BT4-3071-0007

Dörtlü Buton Kutusu  
Korumalı  
80x170x73

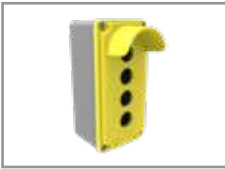

BT4-3071-0017

Beşli Buton Kutusu  
Korumalı  
80x230x73



BT4-4071-0007

Altılı Buton Kutusu  
Korumalı  
80x230x73

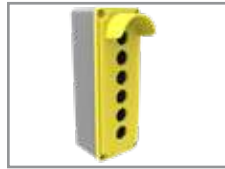

BT4-4071-0017

YENİ

**B** bemis



## ATEX EX-PROOF ÜRÜN ÖZELLİKLERİ

- ▶ Yanıcı ve parlayıcı gazlı ortamlar için **ZONE 1, ZONE 2**
- ▶ Yanıcı ve parlayıcı tozlu ortamlar için **ZONE 21, ZONE 22** tehlikeli bölgelerde kullanılabilir.
- ▶ Elektrostatik toz boya.
- ▶ Paslanmaz çelik düşmez vida sistemi.
- ▶ Bakım esnasında değiştirilebilir sızdırmaz conta.
- ▶ İçten ve dıştan topraklama bağlantısı.
- ▶ IP67 koruma sınıfı.
- ▶ Darbe dayanımı yüksek gövde.
- ▶ Çalışma sıcaklık aralığı -20 °C / +60 °C

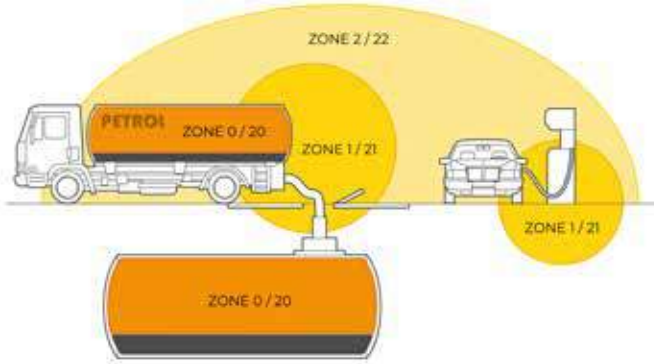

### İç Topraklama Bağlantı Noktası

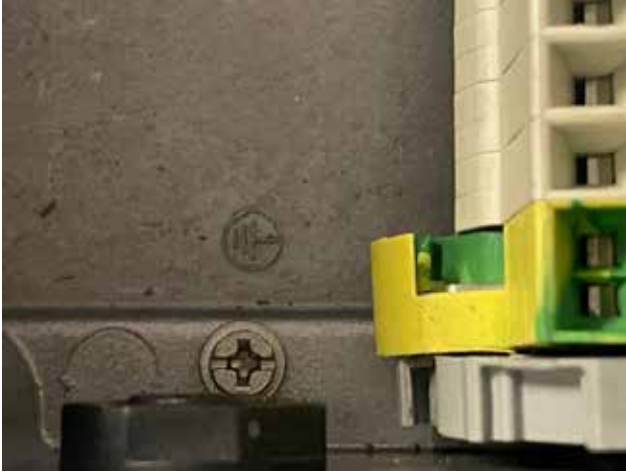

### Dış Topraklama Bağlantı Noktası



YENİ

100  
yüzde  
yerli...

**B** bemis

5 YIL  
GARANTİ

### Atex Ex-Proof Buat ve Buton Kutuları

Alüminyum



YERLİ  
ÜRETİM



EX-Proof  
Buat ve Buton

Üreten Ülke Güçlüdür

YENİ

B bemis

## Alüminyum Buat

| Ürün Kodu       | Ürün Ölçüleri (mm)      | IP   | Kutu | Koli | Fiyat        |
|-----------------|-------------------------|------|------|------|--------------|
| EXBB3-2103-1017 | 65X65X40                | IP67 | 1    | 16   | 702,00 TL    |
| EXBB3-2113-1017 | 65X100X40               | IP67 | 1    | 10   | 835,00 TL    |
| EXBB3-2123-1107 | 100X130X75              | IP67 | 1    | 24   | 1.581,00 TL  |
| EXBB3-2131-0087 | 80x80x60                | IP67 | 1    | 65   | 1.188,00 TL  |
| EXBB3-2131-0097 | 80x80x73                | IP67 | 1    | 45   | 1.335,00 TL  |
| EXBB3-2133-1047 | 130X230X90              | IP67 | 1    | 9    | 3.779,00 TL  |
| EXBB3-2143-1047 | 160X160X90              | IP67 | 1    | 12   | 3.094,00 TL  |
| EXBB3-2153-1047 | 160X260X90              | IP67 | 1    | 7    | 6.650,00 TL  |
| EXBB3-2150-1047 | 160X260X90 (Menteşeli)  | IP67 | 1    | 7    | 7.211,00 TL  |
| EXBB3-2160-1047 | 190X350X90 (Menteşeli)  | IP67 | 1    | 3    | 9.329,00 TL  |
| EXBB3-2163-1047 | 190X350X90              | IP67 | 1    | 3    | 8.503,00 TL  |
| EXBB3-2170-1057 | 250X250X110 (Menteşeli) | IP67 | 1    | 4    | 8.994,00 TL  |
| EXBB3-2173-1057 | 250X250X110             | IP67 | 1    | 4    | 8.209,00 TL  |
| EXBB3-2180-1067 | 310X400X140 (Menteşeli) | IP67 | 1    | 2    | 14.682,00 TL |
| EXBB3-2183-1067 | 310X400X140             | IP67 | 1    | 2    | 14.102,00 TL |
| EXBB3-2190-1067 | 230X330X140 (Menteşeli) | IP67 | 1    | 1    | 11.878,00 TL |
| EXBB3-2193-1067 | 230X330X140             | IP67 | 1    | 1    | 10.669,00 TL |
| EXBB3-2231-0097 | 80x130x73               | IP67 | 1    | 35   | 1.534,00 TL  |
| EXBB3-2331-0097 | 80x170x73               | IP67 | 1    | 22   | 1.739,00 TL  |
| EXBB3-2431-0097 | 80x230x73               | IP67 | 1    | 15   | 2.682,00 TL  |
| EXBB3-2531-0107 | 100x100x75              | IP67 | 1    | 30   | 1.608,00 TL  |
| EXBB3-2631-0047 | 130x130x90              | IP67 | 1    | 18   | 3.514,00 TL  |
| EXBB3-2731-0047 | 130x190x90              | IP67 | 1    | 12   | 3.880,00 TL  |
| EXBB3-2831-0047 | 170x190x90              | IP67 | 1    | 1    | 4.503,00 TL  |
| EXBB3-2931-0047 | 190x250x90              | IP67 | 1    | 1    | 8.360,00 TL  |

65x65x40



EXBB3-2103-1017

65x100x40



EXBB3-2113-1017

80x80x60



EXBB3-2131-0087

80x80x73



EXBB3-2131-0097

80x130x73



EXBB3-2231-0097

80x170x73



EXBB3-2331-0097

80x230x73



EXBB3-2431-0097

100x100x75



EXBB3-2531-0107

100x130x75



EXBB3-2123-1107

130x130x90



EXBB3-2631-0047

130x190x90



EXBB3-2731-0047

130x230x90



EXBB3-2133-1047

160x160x90



EXBB3-2143-1047

160x260x90



EXBB3-2153-1047

170x190x90



EXBB3-2831-0047

190x250x90



EXBB3-2931-0047

190x350x90



EXBB3-2163-1047

190x350x90 (Menteşeli)



EXBB3-2160-1047

250x250x110



EXBB3-2173-1057

250x250x110 (Menteşeli)



EXBB3-2170-1057

310x400x140



EXBB3-2183-1067

310x400x140 (Menteşeli)



EXBB3-2180-1067

230x330x140



EXBB3-2193-1067

230x330x140 (Menteşeli)



EXBB3-2190-1067

| Ürün Kodu       | Açıklama          | Ürün Ölçüleri | IP   | Kutu | Koli | Fiyat       |
|-----------------|-------------------|---------------|------|------|------|-------------|
| EXBT4-1001-0007 | 1'li Buton Kutusu | 80x80x60      | IP67 | 1    | 65   | 1.463,00 TL |
| EXBT4-1001-0017 | 1'li Buton Kutusu | 80x80x73      | IP67 | 1    | 45   | 1.649,00 TL |
| EXBT4-2001-0007 | 2'li Buton Kutusu | 80x130x73     | IP67 | 1    | 35   | 1.767,00 TL |
| EXBT4-3001-0007 | 3'lü Buton Kutusu | 80x170x73     | IP67 | 1    | 22   | 2.074,00 TL |
| EXBT4-3001-0017 | 4'lü Buton Kutusu | 80x170x73     | IP67 | 1    | 22   | 2.118,00 TL |
| EXBT4-4001-0007 | 5'li Buton Kutusu | 80x230x73     | IP67 | 1    | 15   | 2.589,00 TL |
| EXBT4-4001-0017 | 6'li Buton Kutusu | 80x230x73     | IP67 | 1    | 15   | 2.827,00 TL |

Tekli Buton Kutusu  
80x80x60



EXBT4-1001-0007

Tekli Buton Kutusu  
80x80x73



EXBT4-1001-0017

İkili Buton Kutusu  
80x130x73



EXBT4-2001-0007

Üçlü Buton Kutusu  
80x170x73



EXBT4-3001-0007

Dörtlü Buton Kutusu  
80x170x73



EXBT4-3001-0017

Beşli Buton Kutusu  
80x230x73



EXBT4-4001-0007

Altılı Buton Kutusu  
80x230x73



EXBT4-4001-0017

| Ürün Kodu       | Açıklama                   | Ürün Ölçüleri | IP   | Kutu | Koli | Fiyat       |
|-----------------|----------------------------|---------------|------|------|------|-------------|
| EXBT4-1071-0007 | 1'li Korumalı Buton Kutusu | 80x80x60      | IP67 | 1    | 65   | 1.895,00 TL |
| EXBT4-1071-0017 | 1'li Korumalı Buton Kutusu | 80x80x73      | IP67 | 1    | 45   | 1.766,00 TL |
| EXBT4-2071-0007 | 2'li Korumalı Buton Kutusu | 80x130x73     | IP67 | 1    | 35   | 2.067,00 TL |
| EXBT4-3071-0007 | 3'lü Korumalı Buton Kutusu | 80x170x73     | IP67 | 1    | 22   | 2.323,00 TL |
| EXBT4-3071-0017 | 4'lü Korumalı Buton Kutusu | 80x170x73     | IP67 | 1    | 22   | 2.404,00 TL |
| EXBT4-4071-0007 | 5'li Korumalı Buton Kutusu | 80x230x73     | IP67 | 1    | 15   | 2.864,00 TL |
| EXBT4-4071-0017 | 6'li Korumalı Buton Kutusu | 80x230x73     | IP67 | 1    | 15   | 3.002,00 TL |

Tekli Buton Kutusu  
Korumalı  
80x80x60



EXBT4-1071-0007

Tekli Buton Kutusu  
Korumalı  
80x80x73



EXBT4-1071-0017

İkili Buton Kutusu  
Korumalı  
80x130x73



EXBT4-2071-0007

Üçlü Buton Kutusu  
Korumalı  
80x170x73



EXBT4-3071-0007

Dörtlü Buton Kutusu  
Korumalı  
80x170x73



EXBT4-3071-0017

Beşli Buton Kutusu  
Korumalı  
80x230x73



EXBT4-4071-0007

Altılı Buton Kutusu  
Korumalı  
80x230x73



EXBT4-4071-0017



ÖZEL

IP67  
MAKARA SERİSİ

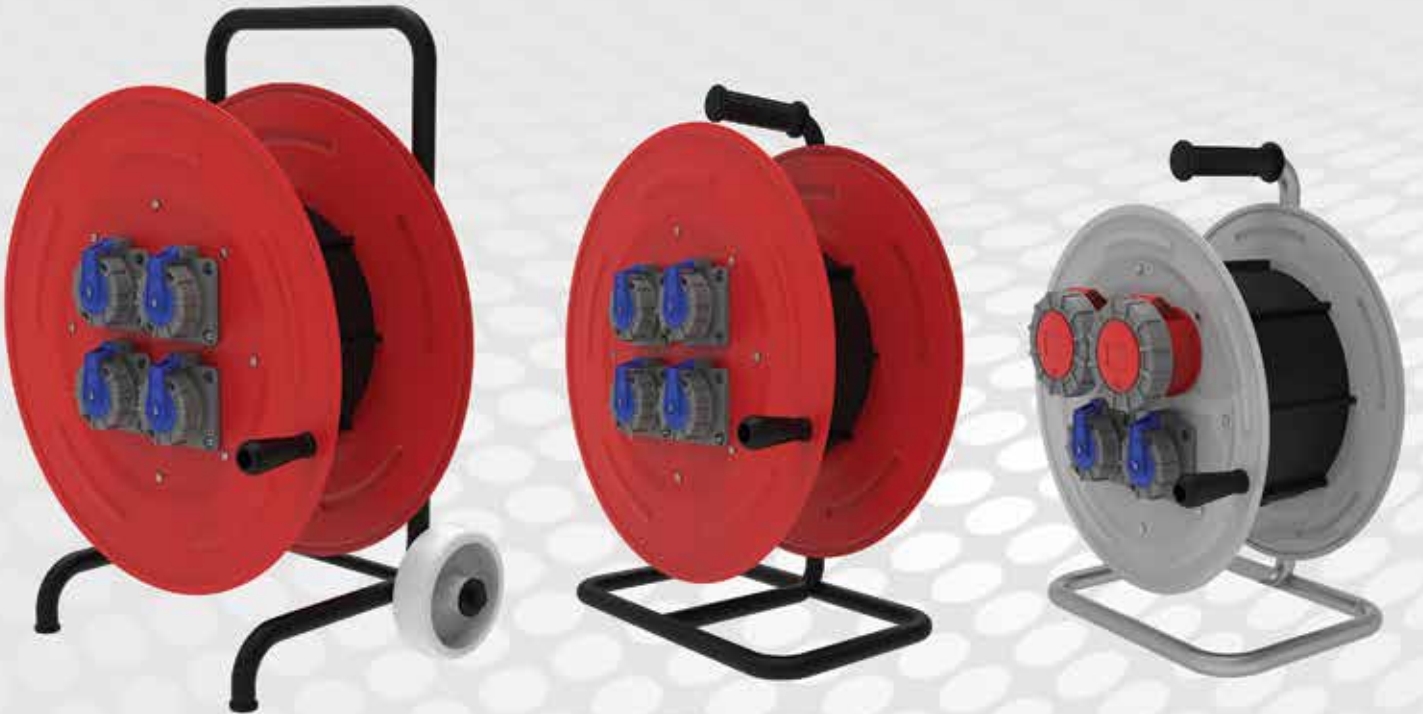



100  
yüzde  
yerli...

**B** bemis

5 YIL  
GARANTİ

### Kablo Makaraları

Metal - Plastik



Üreten Ülke Güçlüdür

## BEMİS KABLO MAKARASI KAPASİTE TABLOSU

| Makara Modeli | KABLO KESİTİ VE UZUNLUĞU (metre) |         |       |       |         |         |       |       |         |         |       |       |
|---------------|----------------------------------|---------|-------|-------|---------|---------|-------|-------|---------|---------|-------|-------|
|               | 3x1.5tr                          | 3x2.5tr | 3x4tr | 3x6tr | 4x1.5tr | 4x2.5tr | 4x4tr | 4x6tr | 5x1.5tr | 5x2.5tr | 5x4tr | 5x6tr |
| BM1           | 25                               | 15      | 13    | 10    |         |         |       |       |         |         |       |       |
| BM2           | 50                               | 30      | 25    | 15    |         |         |       |       |         |         |       |       |
| BM3           | 70                               | 50      | 35    | 25    |         |         |       |       |         |         |       |       |
| BM4           | 80                               | 60      | 40    | 35    | 70      | 45      | 40    | 25    | 60      | 40      | 25    | 20    |
| BM5           | 170                              | 130     | 100   | 90    | 150     | 120     | 95    | 70    | 120     | 100     | 75    | 40    |
| BM6           | 170                              | 130     | 100   | 90    | 150     | 120     | 95    | 70    | 120     | 100     | 75    | 40    |
| BM7           | 15                               | 10      |       |       |         |         |       |       |         |         |       |       |
| BM8           | 25                               | 20      | 15    | 10    |         |         |       |       |         |         |       |       |
| BM9           | 50                               | 35      | 25    | 20    |         |         |       |       |         |         |       |       |

Tablo H05VF-F kablo dış çapı baz alınarak hesaplanmıştır. Veriler kullanılan kablo markası cinsi ve kullanıcıya göre değişkenlik gösterebilir.

### METAL MAKARA ÖZELLİKLERİ

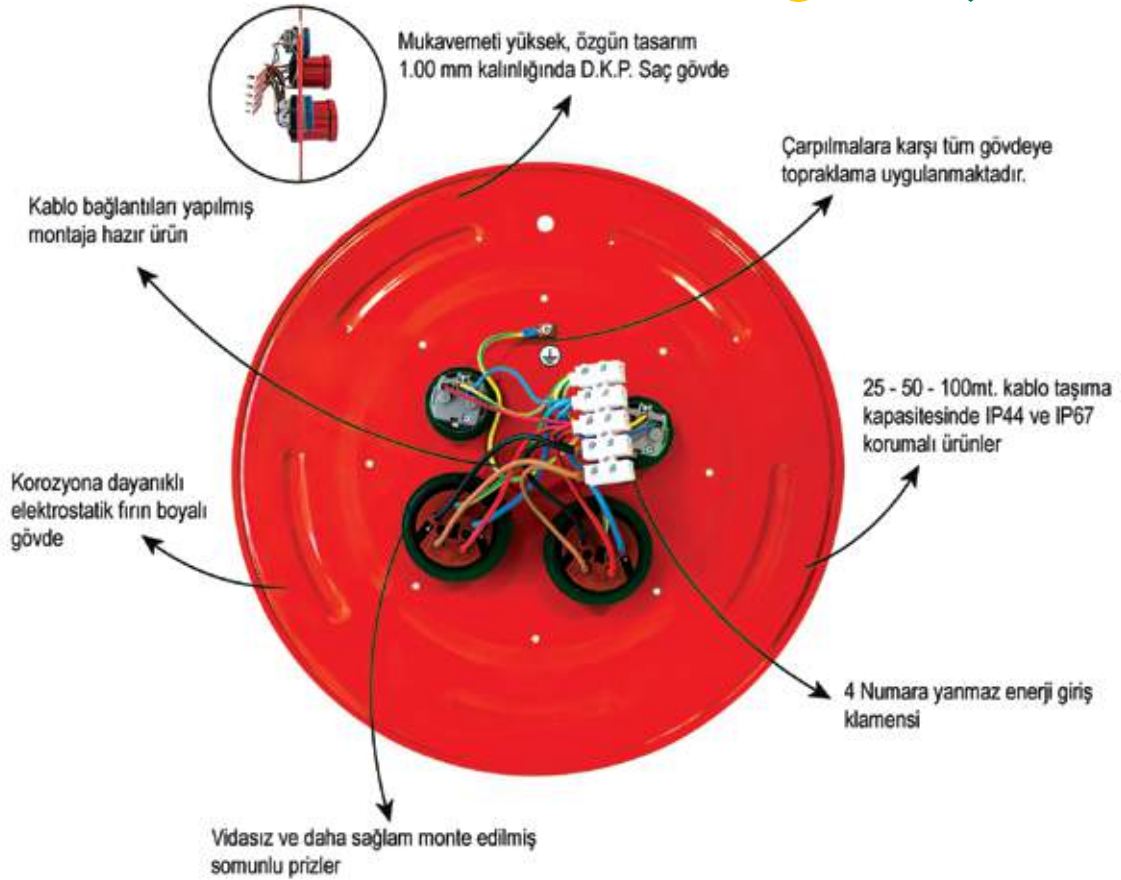



4 Ad. 1/16A. 220V. Prizli  
3x1,5mm TTR 15 Mt. Kapasiteli  
Plastik Makara



BM7-1103-0000

4 Ad. 1/16A. 220V. Prizli  
3x1,5mm TTR 15 Mt. Kablolu  
Plastik Makara



BM7K1103-0000

4 Ad. 1/16A. 220V. Prizli  
3x1,5mm TTR 25 Mt. Kapasiteli  
Plastik Makara



BM8-2103-0000

4 Ad. 1/16A. 220V. Prizli  
3x1,5mm TTR 25 Mt. Kablolu  
Plastik Makara



BM8K2103-0000

4 Ad. 1/16A. 220V. Prizli  
3x1,5mm TTR 25 Mt. Kapasiteli  
Termal Sigortalı Plastik Makara



BM8-2104-0000

4 Ad. 1/16A. 220V. Prizli  
3x1,5mm TTR 25 Mt. Kablolu  
Termal Sigortalı Plastik Makara



BM8K2104-0000

4 Ad. 1/16A. 220V. Prizli  
3x1,5mm TTR 50 Mt. Kapasiteli  
Plastik Makara



BM9-3103-0000

4 Ad. 1/16A. 220V. Prizli  
3x1,5mm TTR 50 Mt. Kablolu  
Plastik Makara



BM9K3103-0000

4 Ad. 1/16A. 220V. Prizli  
3x1,5mm TTR 50 Mt. Kapasiteli  
Termal Sigortalı Plastik Makara



BM9-3104-0000

4 Ad. 1/16A. 220V. Prizli  
3x1,5mm TTR 50 Mt. Kablolu  
Termal Sigortalı Plastik Makara



BM9K3104-0000

3 Ad. 1/16A. 220V. IP54 Prizli  
3x1,5mm TTR 25 Mt. Kapasiteli  
Termal Sigortalı Plastik Makara



BM8-2357-0004

3 Ad. 1/16A. 220V. IP54 Prizli  
3x1,5mm TTR 50 Mt. Kapasiteli  
Termal Sigortalı Plastik Makara



BM9-3357-0004

Prizsiz Kulaklı Kapaklı  
3x1,5mm TTR 25 Mt. Kapasiteli  
Metal Makara



BM1-2102-0000

4 Ad. 1/16A. 220V. Prizli  
3x1,5mm TTR 25 Mt. Kapasiteli  
Metal Makara



BM1-2103-0000

4 Ad. 1/16A. 220V. Prizli  
3x1,5mm TTR 25 Mt. Kablolu  
Metal Makara



BM1K2103-0000

Metal

Prizsiz Kulaklı Kapaklı  
3x1,5mm TTR 50 Mt. Kapasiteli  
Metal Makara



BM2

BM2-3102-0000

4 Ad. 1/16A. 220V. Prizli  
3x1,5mm TTR 50 Mt. Kapasiteli  
Metal Makara



BM2

BM2-3103-0000

4 Ad. 1/16A. 220V. Prizli  
3x2,5mm TTR 50 Mt. Kablolü  
Metal Makara



BM2

BM2K3103-0000

4 Ad. 1/16A. 220V. Prizli  
3x2,5mm TTR 25 Mt. Kablolü  
Metal Makara



BM2

BM2K3103-0022

Metal

Prizsiz 3x2,5mm TTR 50 Mt.  
Kapasiteli Kulaklı Kapaklı  
Metal Makara



BM3

BM3-4102-0000

4 Ad. 1/16A. 220V. Prizli  
3x2,5mm TTR 50 Mt. Kapasiteli  
Metal Makara



BM3

BM3-4403-0000

3 Ad. 1/16A. 220V. Prizli  
3x2,5mm TTR 50 Mt. Kapasiteli  
Metal Makara



BM3

BM3-4303-0000

Metal

Prizsiz 5x2,5mm TTR 40 Mt.  
Kapasiteli Metal Makara



BM4

BM4-5000-0000

Prizsiz 5x2,5mm TTR 40 Mt.  
Kapasiteli Kulaklı Kapaklı  
Metal Makara



BM4

BM4-5102-0000

6 Ad. 1/16A. 220V. Prizli  
5x2,5mm TTR 40 Mt. Kapasiteli  
Metal Makara

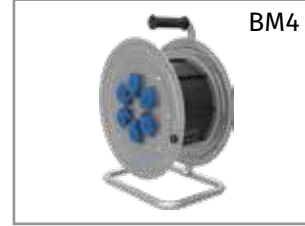

BM4

BM4-5603-0000

2 Ad. 1/16A. 220V. 1 Ad. 3/25A. 380V.  
Prizli 5x2,5mm TTR 40 Mt. Kapasiteli  
Metal Makara



BM4

BM4-5203-1060

Metal

Prizsiz 5x2,5mm TTR 50 Mt.  
Kapasiteli Metal Makara



BM5

BM5-6000-0000

4 Ad. 1/16A. 220V. IP67 Prizli  
5x2,5mm TTR 50 Mt. Kapasiteli  
Metal Makara



BM5

BM5-6431-0000

2 Ad. 1/16A. 220V. 1 Ad. 5/32A. 380V.  
1 Ad. 5/16A. 380V. IP67 Prizli 5x2,5mm  
TTR 50 Mt. Kapasiteli Metal Makara

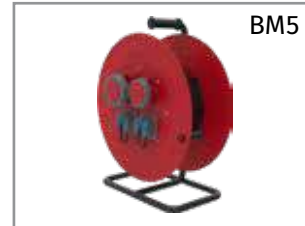

BM5

BM5-6231-1611

3 Ad. 1/16A. 220V. Prizli  
5x2,5mm TTR 50 Mt. Kapasiteli  
Metal Makara



BM5

BM5-6303-0000

Metal

Prizsiz 5x2,5mm TTR 100 Mt.  
Kapasiteli Prizsiz Arabalı  
Metal Makara



BM6

BM6-7000-0000

3 Ad. 1/16A. 220V. Prizli  
5x2,5mm TTR 100 Mt. Kapasiteli  
Arabalı Metal Makara



BM6

BM6-7303-0000

2 Ad. 1/16A. 220V. 2 Ad. 5/32A. 380V.  
IP67 Prizli 5x2,5mm TTR 100 Mt.  
Kapasiteli Arabalı Metal Makara



BM6

BM6-7231-2610

4 Ad. 1/16A. 220V. IP67 Prizli  
5x2,5mm TTR 100 Mt. Kapasiteli  
Arabalı Metal Makara



BM6

BM6-7431-0000

**3x1,5mm TTR 25m. Kapasiteli**

| Ürün Kodu     | Açıklama   | IP   | Kutu | Koli | Fiyat       |
|---------------|--|------|------|------|-------------|
| BM1-2102-0000 | Prizsiz Kulaklı Kapaklı Metal Makara 3x1,5mm TTR 25m. Kapasiteli | IP44 | 1    | 0    | 1.040,00 TL |
| BM1-2103-0000 | 1/16A. 4 Prizli Metal Makara 3x1,5mm TTR 25m. Kapasiteli         | IP44 | 1    | 0    | 1.335,00 TL |
| BM1K2103-0000 | 1/16A. 4 Prizli Metal Makara 3x1,5mm TTR 25m. Kablolu            | IP44 | 1    | 0    | FİYAT ALIN  |

**3x1,5mm TTR 50m. Kapasiteli**

| Ürün Kodu     | Açıklama   | IP   | Kutu | Koli | Fiyat       |
|---------------|--|------|------|------|-------------|
| BM2-3102-0000 | Prizsiz Kulaklı Kapaklı Metal Makara 3x1,5mm TTR 50m. Kapasiteli | IP44 | 1    | 0    | 1.182,00 TL |
| BM2-3103-0000 | 1/16A. 4 Prizli Metal Makara 3x1,5mm TTR 50m. Kapasiteli         | IP44 | 1    | 0    | 1.462,00 TL |
| BM2K3103-0000 | 1/16A. 4 Prizli Metal Makara 3x1,5mm TTR 50m. Kablolu            | IP44 | 1    | 0    | FİYAT ALIN  |
| BM2K3103-0022 | 1/16A. 220V. 4 Ad. Prizli Metal Makara 3x2,5mm TTR 25m. Kablolu  | IP44 | 1    | 0    | FİYAT ALIN  |

**3x2,5mm TTR 50m. Kapasiteli**

| Ürün Kodu     | Açıklama   | IP   | Kutu | Koli | Fiyat       |
|---------------|--|------|------|------|-------------|
| BM3-4102-0000 | Prizsiz Kulaklı Kapaklı Metal Makara 3x2,5mm TTR 50m. Kapasiteli                         | IP44 | 1    | 0    | 1.503,00 TL |
| BM3-4108-2030 | 1/16A. 2 Ad. 3/16A. 220V. 1 Ad. Prizli Metal Makara 3x2,5mm TTR 50m. Kapasiteli          | IP44 | 1    | 0    | 2.159,00 TL |
| BM3-4203-0000 | 1/16A. 2 Ad. Prizli Metal Makara 3x2,5mm TTR 50m. Kapasiteli                             | IP44 | 1    | 0    | 1.816,00 TL |
| BM3-4203-1060 | 1/16A. 220V. 2 Ad. 3/25A. 380V. 1 Ad. Prizli Metal Makara 3x2,5mm TTR 50m. Kapasiteli    | IP44 | 1    | 0    | 2.177,00 TL |
| BM3-4224-0000 | 3/16A. 24V. 2 Ad. Prizli Metal Makara 3x2,5mm TTR 50m. Kapasiteli                        | IP44 | 1    | 0    | 2.718,00 TL |
| BM3-4303-0000 | 1/16A. 220V. 3 Ad. Prizli Metal Makara 3x2,5mm TTR 50m. Kapasiteli                       | IP44 | 1    | 0    | 2.015,00 TL |
| BM3-4303-0004 | 1/16A. 220V. 3 Ad. Prizli Metal Makara 3x2,5mm TTR 50m. Kapasiteli Termal Sigortalı      | IP44 | 1    | 0    | 2.240,00 TL |
| BM3-4321-0004 | 1/16A. 220V. 3 Ad. Fransız Prizli Metal Makara 3x2,5mm TTR 50m. Kap. Termal Sigortalı    | IP44 | 1    | 0    | 2.121,00 TL |
| BM3-4357-0004 | 1/16A. 220V. IP54 3 Ad. Prizli Metal Makara 3x2,5mm TTR 50m. Kapasiteli Termal Sigortalı | IP54 | 1    | 0    | 2.206,00 TL |
| BM3-4403-0000 | 1/16A. 220V. 4 Ad. Prizli Metal Makara 3x2,5mm TTR 50m. Kapasiteli                       | IP44 | 1    | 0    | 2.215,00 TL |
| BM3K4403-0000 | 1/16A. 220V. 4 Ad. Prizli Metal Makara 3x2,5mm TTR 50m. Kablolu                          | IP44 | 1    | 0    | FİYAT ALIN  |

**5x2,5mm TTR 40m. Kapasiteli**

| Ürün Kodu     | Açıklama  | IP   | Kutu | Koli | Fiyat       |
|---------------|---|------|------|------|-------------|
| BM4-5000-0000 | Prizsiz Metal Makara 5x2,5mm TTR 40m. Kapasiteli  | IP44 | 1    | 0    | 2.207,00 TL |
| BM4-5102-0000 | Prizsiz Kulaklı Kapaklı Metal Makara 5x2,5mm TTR 40m. Kapasiteli                                      | IP44 | 1    | 0    | 2.302,00 TL |
| BM4-5103-1160 | 1/16A. 220V. 1 Ad. 5/32A. 380V. 1 Ad. Prizli Metal Makara 5x2,5mm TTR 40m. Kapasiteli                 | IP44 | 1    | 0    | 2.980,00 TL |
| BM4-5103-2060 | 1/16A. 220V. 1 Ad. 3/25A. 380V. 2 Ad. Prizli Metal Makara 5x2,5mm TTR 40m. Kapasiteli                 | IP44 | 1    | 0    | 2.983,00 TL |
| BM4-5112-2030 | 1/16A. 220V. 2 Ad. 5/16A. 380V. 1 Ad. Prizli Metal Makara 5x2,5mm TTR 40m. Kapasiteli                 | IP44 | 1    | 0    | 3.054,00 TL |
| BM4-5203-1060 | 1/16A. 220V. 2 Ad. 3/25A. 380V. 1 Ad. Prizli Metal Makara 5x2,5mm TTR 40m. Kapasiteli                 | IP44 | 1    | 0    | 2.840,00 TL |
| BM4-5203-1080 | 1/16A. 220V. 2 Ad. 3/16A. 220V. 1 Ad. Prizli Metal Makara 5x2,5mm TTR 40m. Kapasiteli                 | IP44 | 1    | 0    | 2.844,00 TL |
| BM4-5203-1160 | 1/16A. 220V. 2 Ad. 5/32A. 380V. 1 Ad. Prizli Metal Makara 5x2,5mm TTR 40m. Kapasiteli                 | IP44 | 1    | 0    | 3.143,00 TL |
| BM4-5203-2060 | 1/16A. 220V. 2 Ad. 3/25A. 380V. 2 Ad. Prizli Metal Makara 5x2,5mm TTR 40m. Kapasiteli                 | IP44 | 1    | 0    | 3.146,00 TL |
| BM4-5203-2080 | 1/16A. 220V. 2 Ad. 3/16A. 220V. 2 Ad. Prizli Metal Makara 5x2,5mm TTR 40m. Kapasiteli                 | IP44 | 1    | 0    | 3.154,00 TL |
| BM4-5203-2110 | 1/16A. 220V. 2 Ad. 4/16A. 380V. 2 Ad. Prizli Metal Makara 5x2,5mm TTR 40m. Kapasiteli                 | IP44 | 1    | 0    | 3.364,00 TL |
| BM4-5203-2120 | 1/16A. 220V. 2 Ad. 5/16A. 380V. 2 Ad. Prizli Metal Makara 5x2,5mm TTR 40m. Kapasiteli                 | IP44 | 1    | 0    | 3.574,00 TL |
| BM4-5203-2150 | 1/16A. 220V. 2 Ad. 4/32A. 380V. 2 Ad. Prizli Metal Makara 5x2,5mm TTR 40m. Kapasiteli                 | IP44 | 1    | 0    | 3.589,00 TL |
| BM4-5203-2160 | 1/16A. 220V. 2 Ad. 5/32A. 380V. 2 Ad. Prizli Metal Makara 5x2,5mm TTR 40m. Kapasiteli                 | IP44 | 1    | 0    | 3.753,00 TL |
| BM4-5303-0000 | 1/16A 220V IP44 3 Ad. Prizli Metal Makara 5x2,5mm TTR 40m. Kapasiteli                                 | IP44 | 1    | 0    | 2.697,00 TL |
| BM4-5303-1060 | 1/16A. 220V. 3 Ad. 3/25A. 380V. 1 Ad. Prizli Metal Makara 5x2,5mm TTR 40m. Kapasiteli                 | IP44 | 1    | 0    | 3.003,00 TL |
| BM4-5303-1110 | 1/16A. 220V. 3 Ad. 4/16A. 380V. 1 Ad. Prizli Metal Makara 5x2,5mm TTR 40m. Kapasiteli                 | IP44 | 1    | 0    | 3.112,00 TL |
| BM4-5303-1120 | 1/16A. 220V. 3 Ad. 5/16A. 380V. 1 Ad. Prizli Metal Makara 5x2,5mm TTR 40m. Kapasiteli                 | IP44 | 1    | 0    | 3.218,00 TL |
| BM4-5303-1150 | 1/16A. 220V. 3 Ad. 4/32A. 380V. 1 Ad. Prizli Metal Makara 5x2,5mm TTR 40m. Kapasiteli                 | IP44 | 1    | 0    | 3.225,00 TL |
| BM4-5303-1160 | 1/16A. 220V. 3 Ad. 5/32A. 380V. 1 Ad. Prizli Metal Makara 5x2,5mm TTR 40m. Kapasiteli                 | IP44 | 1    | 0    | 3.307,00 TL |
| BM4-5603-0000 | 1/16A. 220V. 6 Ad. Prizli Metal Makara 5x2,5mm TTR 40m. Kapasiteli                                    | IP44 | 1    | 0    | 3.187,00 TL |
| BM4-5031-0000 | Prizsiz Metal Makara 5x2,5mm TTR 40m. Kapasiteli  | IP67 | 1    | 0    | 2.584,00 TL |
| BM4-5231-1610 | 1/16A. 220V. 2 Ad. 5/32A. 380V. 1 Ad. IP67 Prizli Metal Makara 5x2,5mm TTR 40m. Kapasiteli            | IP67 | 1    | 0    | 4.564,00 TL |
| BM4-5431-0000 | 1/16A. 220V. 4 Ad. IP67 Prizli Metal Makara 5x2,5mm TTR 40m. Kapasiteli                               | IP67 | 1    | 0    | 4.386,00 TL |
| BM4-5231-2610 | 1/16A. 220V. 2 Ad. 5/32A. 380V. 2 Ad. IP67 Prizli Metal Makara 5x2,5mm TTR 40m. Kapasiteli            | IP67 | 1    | 0    | 5.415,00 TL |
| BM4-5231-1470 | 1/16A. 220V. 2 Ad. 5/16A. 380V. 1 Ad. IP67 Prizli Metal Makara 5x2,5mm TTR 40m. Kapasiteli            | IP67 | 1    | 0    | 4.010,00 TL |
| BM4-5231-1611 | 1/16A. 220V. 2 Ad. 5/32A. 380V. 1 Ad. 5/16A. 380V. 1 Ad. IP67 Prizli Metal Mak. 5x2,5mm TTR 40m. Kap. | IP67 | 1    | 0    | 4.762,00 TL |

## 5x2,5mm TTR 50m. Kapasiteli

| Ürün Kodu     | Açıklama  | IP   | Kutu | Koli | Fiyat       |
|---------------|---|------|------|------|-------------|
| BM5-6000-0000 | Prizsiz Metal Makara 5x2,5mm TTR 50m. Kapasiteli  | IP44 | 1    | 0    | 2.475,00 TL |
| BM5-6102-0000 | Prizsiz Kulaklı Kapaklı Metal Makara 5x2,5mm TTR 50m. Kapasiteli  | IP44 | 1    | 0    | 2.565,00 TL |
| BM5-6103-1161 | 1/16A. 220V. 1 Ad. 5/16A. 380V. 1 Ad. 5/32A. 380V. 1 Ad. Prizli Metal Makara 5x2,5mm TTR 50m. Kapasiteli      | IP44 | 1    | 0    | 3.768,00 TL |
| BM5-6103-2060 | 1/16A. 220V. 1 Ad. 3/25A. 380V. 2 Ad. Prizli Metal Makara 5x2,5mm TTR 50m. Kapasiteli                         | IP44 | 1    | 0    | 3.251,00 TL |
| BM5-6116-0000 | 5/32A. 380V. 1 Ad. Prizli Metal Makara 5x2,5mm TTR 50m. Kapasiteli  | IP44 | 1    | 0    | 3.085,00 TL |
| BM5-6203-1200 | 1/16A. 220V. 2 Ad. 5/63A. 380V. 1 Ad. Prizli Metal Makara 5x2,5mm TTR 50m. Kapasiteli                         | IP44 | 1    | 0    | 4.656,00 TL |
| BM5-6203-2150 | 1/16A. 220V. 2 Ad. 4/32A. 380V. 2 Ad. Prizli Metal Makara 5x2,5mm TTR 50m. Kapasiteli                         | IP44 | 1    | 0    | 3.857,00 TL |
| BM5-6203-2160 | 1/16A. 220V. 2 Ad. 5/32A. 380V. 2 Ad. Prizli Metal Makara 5x2,5mm TTR 50m. Kapasiteli                         | IP44 | 1    | 0    | 4.021,00 TL |
| BM5-6212-2030 | 1/16A. 220V. 2 Ad. 5/16A. 380V. 2 Ad. Prizli Metal Makara 5x2,5mm TTR 50m. Kapasiteli                         | IP44 | 1    | 0    | 3.843,00 TL |
| BM5-6303-0000 | 1/16A. 220V. 3 Ad. Prizli Metal Makara 5x2,5mm TTR 50m. Kapasiteli  | IP44 | 1    | 0    | 2.966,00 TL |
| BM5-6303-1160 | 1/16A. 220V. 3 Ad. 5/32A. 380V. 1 Ad. Prizli Metal Makara 5x2,5mm TTR 50m. Kapasiteli                         | IP44 | 1    | 0    | 3.575,00 TL |
| BM5-6304-0000 | 1/16A. 220V. M.P. 3 Ad. Prizli Metal Makara 5x2,5mm TTR 50m. Kapasiteli                                       | IP44 | 1    | 0    | 3.043,00 TL |
| BM5-6315-0000 | 4/32A. 380V. 3 Ad. Prizli Metal Makara 5x2,5mm TTR 50m. Kapasiteli  | IP44 | 1    | 0    | 4.058,00 TL |
| BM5-6316-0000 | 5/32A. 380V. 3 Ad. Prizli Metal Makara 5x2,5mm TTR 50m. Kapasiteli  | IP44 | 1    | 0    | 4.303,00 TL |
| BM5-6403-0000 | 1/16A. 220V. 4 Ad. Prizli Metal Makara 5x2,5mm TTR 50m. Kapasiteli  | IP44 | 1    | 0    | 3.129,00 TL |
| BM5-6031-0000 | Prizsiz Metal Makara 5x2,5mm TTR 50m. Kapasiteli  | IP67 | 1    | 0    | 2.802,00 TL |
| BM5-6231-2610 | 1/16A. 220V. 2 Ad. 5/32A. 380V. 2 Ad. IP67 Prizli Metal Makara 5x2,5mm TTR 50m. Kapasiteli                    | IP67 | 1    | 0    | 5.244,00 TL |
| BM5-6231-1611 | 1/16A. 220V. 2 Ad. 5/32A. 380V. 1 Ad. 5/16A. 380V. 1 Ad. IP67 Prizli Metal Makara 5x2,5mm TTR 50m. Kapasiteli | IP67 | 1    | 0    | 5.148,00 TL |
| BM5-6431-0000 | 1/16A. 220V. 4 Ad. IP67 Prizli Metal Makara 5x2,5mm TTR 50m. Kapasiteli                                       | IP67 | 1    | 0    | 4.589,00 TL |

## 5x2,5mm TTR 100m. Kapasiteli

| Ürün Kodu     | Açıklama   | IP   | Kutu | Koli | Fiyat       |
|---------------|--|------|------|------|-------------|
| BM6-7000-0000 | Prizsiz Metal Makara 5x2,5mm TTR 100m. Kapasiteli Arabalı  | IP44 | 1    | 0    | 3.713,00 TL |
| BM6-7102-0000 | Prizsiz Kulaklı Kapaklı Metal Makara 5x2,5mm TTR 100m. Kapasiteli  | IP44 | 1    | 0    | 3.791,00 TL |
| BM6-7103-1061 | 1/16A. 220V. 1 Ad. 3/25A. 380V. 1 Ad. 5/32A. 380V. 1 Ad. Prizli Metal Makara 5x2,5mm TTR 100m. Kapasiteli Arabalı      | IP44 | 1    | 0    | 4.792,00 TL |
| BM6-7103-2060 | 1/16A. 220V. 1 Ad. 3/25A. 380V. 2 Ad. Prizli Metal Makara 5x2,5mm TTR 100m. Kapasiteli Arabalı                         | IP44 | 1    | 0    | 4.488,00 TL |
| BM6-7203-1060 | 1/16A. 220V. 2 Ad. 3/25A. 380V. 1 Ad. Prizli Metal Makara 5x2,5mm TTR 100m. Kapasiteli Arabalı                         | IP44 | 1    | 0    | 4.346,00 TL |
| BM6-7203-1061 | 1/16A. 220V. 2 Ad. 3/25A. 380V. 1 Ad. 5/16A. 380V. 1 Ad. Prizli Metal Makara 5x2,5mm TTR 100m. Kapasiteli Arabalı      | IP44 | 1    | 0    | 4.866,00 TL |
| BM6-7203-1062 | 1/16A. 220V. 2 Ad. 3/25A. 380V. 1 Ad. 5/32A. 380V. 1 Ad. Prizli Metal Makara 5x2,5mm TTR 100m. Kapasiteli Arabalı      | IP44 | 1    | 0    | 4.955,00 TL |
| BM6-7203-1120 | 1/16A. 220V. 2 Ad. 5/16A. 380V. 1 Ad. Prizli Metal Makara 5x2,5mm TTR 100m. Kapasiteli Arabalı                         | IP44 | 1    | 0    | 4.560,00 TL |
| BM6-7203-1121 | 1/16A. 220V. 2 Ad. 5/16A. 380V. 1 Ad. 5/32A. 380V. 1 Ad. Prizli Metal Makara 5x2,5mm TTR 100m. Kapasiteli Arabalı      | IP44 | 1    | 0    | 5.169,00 TL |
| BM6-7203-1200 | 1/16A. 220V. 2 Ad. 5/63A. 380V. 1 Ad. Prizli Metal Makara 5x2,5mm TTR 100m. Kapasiteli Arabalı                         | IP44 | 1    | 0    | 5.893,00 TL |
| BM6-7206-2030 | 1/16A. 220V. 2 Ad. 3/25A. 380V. 2 Ad. Prizli Metal Makara 5x2,5mm TTR 100m. Kapasiteli Arabalı                         | IP44 | 1    | 0    | 4.652,00 TL |
| BM6-7211-2030 | 1/16A. 220V. 2 Ad. 4/16A. 380V. 2 Ad. Prizli Metal Makara 5x2,5mm TTR 100m. Kapasiteli Arabalı                         | IP44 | 1    | 0    | 4.870,00 TL |
| BM6-7212-2030 | 1/16A. 220V. 2 Ad. 5/16A. 380V. 2 Ad. Prizli Metal Makara 5x2,5mm TTR 100m. Kapasiteli Arabalı                         | IP44 | 1    | 0    | 5.080,00 TL |
| BM6-7216-2030 | 1/16A. 220V. 2 Ad. 5/32A. 380V. 2 Ad. Prizli Metal Makara 5x2,5mm TTR 100m. Kapasiteli Arabalı                         | IP44 | 1    | 0    | 5.258,00 TL |
| BM6-7303-0000 | 1/16A. 220V. 3 Ad. Prizli Metal Makara 5x2,5mm TTR 100m. Kapasiteli Arabalı  | IP44 | 1    | 0    | 4.203,00 TL |
| BM6-7303-1160 | 1/16A. 220V. 3 Ad. 5/32A. 380V. 1 Ad. Prizli Metal Makara 5x2,5mm TTR 100m. Kapasiteli Arabalı                         | IP44 | 1    | 0    | 4.812,00 TL |
| BM6-7403-0000 | 1/16A. 220V. 4 Ad. Prizli Metal Makara 5x2,5mm TTR 100m. Kapasiteli Arabalı  | IP44 | 1    | 0    | 4.366,00 TL |
| BM6-7406-0000 | 3/25A. 380V. 4 Ad. Prizli Metal Makara 5x2,5mm TTR 100m. Kapasiteli Arabalı  | IP44 | 1    | 0    | 4.937,00 TL |
| BM6-7031-0000 | Prizsiz Metal Makara 5x2,5mm TTR 100m. Kapasiteli  | IP67 | 1    | 0    | 4.322,00 TL |
| BM6-7331-1610 | 1/16A. 220V. 3 Ad. 5/32A. 380V. 1 Ad. IP67 Prizli Metal Makara 5x2,5mm TTR 100m. Kapasiteli Arabalı                    | IP67 | 1    | 0    | 6.538,00 TL |
| BM6-7231-2610 | 1/16A. 220V. 2 Ad. 5/32A. 380V. 2 Ad. IP67 Prizli Metal Makara 5x2,5mm TTR 100m. Kapasiteli Arabalı                    | IP67 | 1    | 0    | 6.763,00 TL |
| BM6-7231-1611 | 1/16A. 220V. 2 Ad. 5/32A. 380V. 1 Ad. 5/16A. 380V. 1 Ad. IP67 Prizli Metal Makara 5x2,5mm TTR 100m. Kapasiteli Arabalı | IP67 | 1    | 0    | 6.674,00 TL |
| BM6-7431-0000 | 1/16A. 220V. 4 Ad. IP67 Prizli Metal Makara 5x2,5mm TTR 100m. Kapasiteli Arabalı                                       | IP67 | 1    | 0    | 6.313,00 TL |

**3x1,5mm TTR 15m. Kapasiteli**

| Ürün Kodu     | Açıklama   | IP   | Kutu | Koli | Fiyat      |
|---------------|--|------|------|------|------------|
| BM7-1103-0000 | 1/16A. 4 Prizli Plastik Makara 3x1,5mm TTR 15m. Kapasiteli | IP44 | 1    | 0    | 647,00 TL  |
| BM7K1103-0000 | 1/16A. 4 Prizli Plastik Makara 3x1,5mm TTR 15m. Kablolu    | IP44 | 1    | 0    | FİYAT ALIN |

**3x1,5mm TTR 25m. Kapasiteli**

| Ürün Kodu     | Açıklama  | IP   | Kutu | Koli | Fiyat       |
|---------------|---|------|------|------|-------------|
| BM8-2102-0000 | Prizsiz K. Kapaklı Plastik Makara 3x1,5mm TTR 25m. Kapasiteli               | IP44 | 1    | 0    | 587,00 TL   |
| BM8-2103-0000 | 1/16A. 4 Prizli Plastik Makara 3x1,5mm TTR 25m. Kapasiteli                  | IP44 | 1    | 0    | 869,00 TL   |
| BM8-2104-0000 | 1/16A. 4 Prizli Plastik Makara 3x1,5mm TTR 25m. Kapasiteli Termal Sigortalı | IP44 | 1    | 0    | 994,00 TL   |
| BM8-2305-0000 | 1/16A. 3 Pano Prizli Plastik Makara 3x1,5mm TTR 25m. Kapasiteli             | IP44 | 1    | 0    | 1.111,00 TL |
| BM8-2306-0000 | 1/16A. 3 Fransız Prizli Plastik Makara 3x1,5mm TTR 25m. Kapasiteli          | IP54 | 1    | 0    | 1.130,00 TL |
| BM8-2357-0004 | 1/16A. 3 Pano Prizli Plastik Makara 3x1,5mm TTR 25m. Kap. Termal Sigortalı  | IP44 | 1    | 0    | 1.231,00 TL |
| BM8K2103-0000 | 1/16A. 4 Prizli Plastik Makara 3x1,5mm TTR 25m. Kablolu                     | IP44 | 1    | 0    | FİYAT ALIN  |
| BM8K2104-0000 | 1/16A. 4 Prizli Plastik Makara 3x1,5mm TTR 25m. Kablolu Termal Sigortalı    | IP44 | 1    | 0    | FİYAT ALIN  |

**3x1,5mm TTR 50m. Kapasiteli**

| Ürün Kodu     | Açıklama  | IP   | Kutu | Koli | Fiyat       |
|---------------|---|------|------|------|-------------|
| BM9-3102-0000 | Prizsiz K. Kapaklı Plastik Makara 3x1,5mm TTR 50m. Kapasiteli               | IP44 | 1    | 0    | 624,00 TL   |
| BM9-3103-0000 | 1/16A. 4 Prizli Plastik Makara 3x1,5mm TTR 50m. Kapasiteli                  | IP44 | 1    | 0    | 909,00 TL   |
| BM9-3104-0000 | 1/16A. 4 Prizli Plastik Makara 3x1,5mm TTR 50m. Kapasiteli Termal Sigortalı | IP44 | 1    | 0    | 1.025,00 TL |
| BM9-3305-0000 | 1/16A. 3 Pano Prizli Plastik Makara 3x1,5mm TTR 50m. Kapasiteli             | IP54 | 1    | 0    | 1.147,00 TL |
| BM9-3306-0000 | 1/16A. 3 Fransız Prizli Plastik Makara 3x1,5mm TTR 50m. Kapasiteli          | IP44 | 1    | 0    | 1.166,00 TL |
| BM9-3357-0004 | 1/16A. 3 Pano Prizli Plastik Makara 3x1,5mm TTR 50m. Kap. Termal Sigorta    | IP44 | 1    | 0    | 1.263,00 TL |
| BM9K3103-0000 | 1/16A. 4 Prizli Plastik Makara 3x1,5mm TTR 50m. Kablolu                     | IP44 | 1    | 0    | FİYAT ALIN  |
| BM9K3104-0000 | 1/16A. 4 Prizli Plastik Makara 3x1,5mm TTR 50m. Kablolu Termal Sigortalı    | IP44 | 1    | 0    | FİYAT ALIN  |
| BM9K3103-0022 | 1/16A. 4 Prizli Plastik Makara 3x2,5mm TTR 25m. Kablolu                     | IP44 | 1    | 0    | FİYAT ALIN  |



BM7-1103-0000



BM8-2305-0000



BM9-3305-0000



**B** bemis



# SAVUNMA SANAYİNE UYGUN ÜRÜNLER

Bemis Teknik Elektrik A.Ş. Aselsan, Havelsan, Roketsan, Askeri Fabrikalar onaylı tedarikçisidir.

100  
yüzde  
yerli...





Tekstil Sektöründe Hareketli Makinalarda Kullanılan Enerji Aktarım Tamburu



Arıtma Tesisi



Oto servislerinde Kullanılan Hava, Su, yağ ve Enerji Aktarımları



Yüksek akım çeken kaynak makinaları için enerji aktarım tamburları



Ayrıca gemilerde oluşan statik elektriğin boşaltılması için topraklama tamburlarımız da mevcuttur.

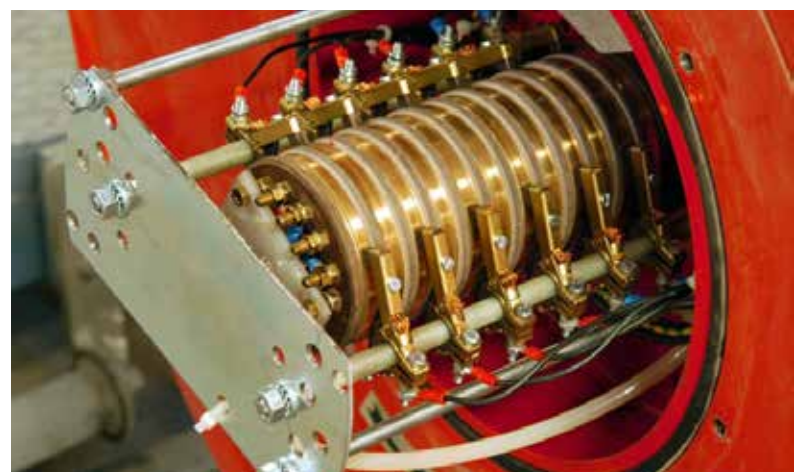

**Endüstride Teknik Çözümler**  
TAMBUR ENERJİ AKTARIM KOLLEKTÖRÜ (10A./40A. 3/16 kutuplu çeşitlerimizdir.)



## Otomatik Sarım Sistemli Tambur Serisi

Metal - Plastik



**Otomatik Sarım Sistemli Enerji Aktarım & Topraklama Tamburları**

| Ürün Kodu     | Açıklama  | IP   | Ad. | Fiyat       |
|---------------|---|------|-----|-------------|
| BE1-3003-0110 | 3Cx1,5mm2x10m. TTR Kablolü Monofaze Kilitlemeli Enerji Aktarım Tamburu Plastik gövde        | IP55 | 1   | 275,00 \$   |
| BE0-3003-0110 | 3Cx1,5mm2x10m. TTR Kablolü Monofaze Kilitlemesiz Enerji Aktarım Tamburu Plastik gövde       | IP55 | 1   | 275,00 \$   |
| BE1-0003-0120 | 3Cx1,5mm2x20m. TTR Kablolü Monofaze Kilitlemeli Enerji Aktarım Tamburu Metal Gövde          | IP55 | 1   | 425,00 \$   |
| BE0-0003-0120 | 3Cx1,5mm2x20m. TTR Kablolü Monofaze Kilitlemesiz Enerji Aktarım Tamburu Metal Gövde         | IP55 | 1   | 425,00 \$   |
| BE0-3003-0120 | 3Cx1,5mm2x20m. TTR Kablolü Monofaze Kilitlemesiz Enerji Aktarım Tamburu Plastik Gövde       | IP55 | 1   | 412,50 \$   |
| BE1-3003-0920 | 3 x 2.5mm <sup>2</sup> 20mt Kablolü Monofaze Kilitlemeli enerji aktarım Tamburu Metal Gövde | IP55 | 1   | 450,00 \$   |
| BE1-4003-0920 | 3 x 2.5mm <sup>2</sup> 20mt Kablolü Monofaze Kilitlemeli enerji aktarım Tamburu Metal Gövde | IP55 | 1   | 440,00 \$   |
| BE1-0003-0315 | 4Cx4mm2x15m. TTR Kablolü Trifaze Kilitlemeli Enerji Aktarım Tamburu                         | IP55 | 1   | 1.181,25 \$ |
| BE0-0003-0315 | 4Cx4mm2x15m. TTR Kablolü Trifaze Kilitlemesiz Enerji Aktarım Tamburu                        | IP55 | 1   | 1.181,25 \$ |
| BE1-0003-0325 | 4Cx4mm2x25m. TTR Kablolü Trifaze Kilitlemeli Enerji Aktarım Tamburu                         | IP55 | 1   | 1.312,50 \$ |
| BE0-0003-0325 | 4Cx4mm2x25m. TTR Kablolü Trifaze Kilitlemesiz Enerji Aktarım Tamburu                        | IP55 | 1   | 1.312,50 \$ |
| BE0-0003-0725 | 5Cx4mm2x25m. TTR Kablolü Trifaze Kilitlemesiz Enerji Aktarım Tamburu                        | IP55 | 1   | 1.487,50 \$ |
| BE1-0003-0340 | 4Cx4mm2x40m. TTR Kablolü Trifaze Kilitlemeli Enerji Aktarım Tamburu                         | IP55 | 1   | 1.725,00 \$ |
| BE0-0003-0340 | 4Cx4mm2x40m. TTR Kablolü Trifaze Kilitlemesiz Enerji Aktarım Tamburu                        | IP55 | 1   | 1.725,00 \$ |
| BE1-0003-0350 | 4Cx4mm2x50m. TTR Kablolü Trifaze Kilitlemeli Enerji Aktarım Tamburu                         | IP55 | 1   | 1.812,50 \$ |
| BE0-0003-0350 | 4Cx4mm2x50m. TTR Kablolü Trifaze Kilitlemesiz Enerji Aktarım Tamburu                        | IP55 | 1   | 1.812,50 \$ |
| BE1-0003-BB15 | Ø50mm2x1mmx15m. Kaynak Kablolü Kilitlemeli Topraklama Tamburu                               | IP55 | 1   | 1.500,00 \$ |
| BE1-0003-AA20 | Ø25mm2x1mmx20m. Kaynak Kablolü Kilitlemeli Topraklama Tamburu                               | IP55 | 1   | 1.250,00 \$ |

**Monofaze - Elektrik Aktarım Tamburu  
Kilitlemeli - Plastik Gövde**

**BE1-3003-0110** Kutu 1 Ad.

**Monofaze - Elektrik Aktarım Tamburu  
Kilitlemesiz - Plastik Gövde**

**BE0-3003-0120** Kutu 1 Ad.

**Monofaze - Elektrik Aktarım Tamburu  
Kilitlemeli - Metal Gövde**

**BE1-0003-0120** Kutu 1 Ad.

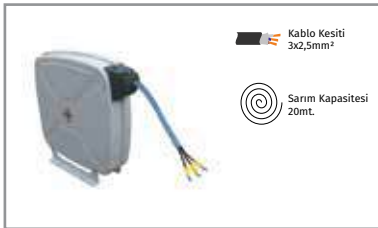
**Monofaze - Elektrik Aktarım Tamburu  
Kilitlemeli - Metal Gövde**

**BE1-4003-0920** Kutu 1 Ad.

**Monofaze - Elektrik Aktarım Tamburu  
Kilitlemeli - Metal Gövde**

**BE1-3003-0920** Kutu 1 Ad.

**Trifaze - Elektrik Aktarım Tamburu  
Kilitlemeli - Metal Gövde**

**BE1-0003-0325** Kutu 1 Ad.

**Trifaze - Elektrik Aktarım Tamburu  
Kilitlemeli - Metal Gövde**

**BE1-0003-0350** Kutu 1 Ad.

**Topraklama ve Kaynak için  
Elektrik Aktarım Tamburu  
Kilitlemeli - Metal Gövde**

**BE1-0003-AA20** Kutu 1 Ad.

**Topraklama ve Kaynak için  
Elektrik Aktarım Tamburu  
Kilitlemeli - Metal Gövde**

**BE1-0003-BB15** Kutu 1 Ad.

**Not:** Fiyatları döviz olan ürünlerde vade ve indirim uygulanmamaktadır. Teknik detaylara [www.bemis.com.tr](http://www.bemis.com.tr) web sitemizden ulaşabilirsiniz.

Otomatik Sarım Sistemli Hava Aktarım Tamburları

| Ürün Kodu     | Açıklama  | IP   | Ad. | Fiyat       |
|---------------|---|------|-----|-------------|
| BHA-3113-0009 | İØ6mmx9m. Poliüretan Hortumlu Hava Aktarım Tamburu Plastik                        | IP55 | 1   | 212,50 \$   |
| BHA-0433-0015 | İØ13mmx15m. Sentetik Kauçuk Hortumlu Hava Aktarım Tamburu                         | IP55 | 1   | 562,50 \$   |
| BHA-0210-0115 | İØ8mmx15m. Pu. Hor. 2 Ad. Hava ve 3Cx1,5mm2x15m. TTR Kab. 1 Ad. Mnf. En. Ak. Tam. | IP55 | 1   | 1.156,25 \$ |
| BHA-0233-0020 | İØ8mmx20m. Sentetik Kauçuk Hortumlu Hava Aktarım Tamburu                          | IP55 | 1   | 562,50 \$   |
| BHA-0213-0020 | İØ8mmx20m. Poliüretan Hortumlu Hava Aktarım Tamburu metal                         | IP55 | 1   | 562,50 \$   |
| BHA-3213-0020 | İØ8mmx20m. Poliüretan Hortumlu Hava Aktarım Tamburu Plastik Gövde                 | IP55 | 1   | 500,00 \$   |

2 Hava & Enerji Aktarım Tamburu



- Kablo Kesiti 3x1,5mm<sup>2</sup> TTR
- Sarım Kapasitesi 15mt.
- 10 Kg/cm<sup>2</sup> basınç dayanımlı, İØ 8mm çapında, 15 metre uzunluğunda 2 Ad. hava aktarım hortumu

BHA-0210-0115



Hava Aktarım Tamburu

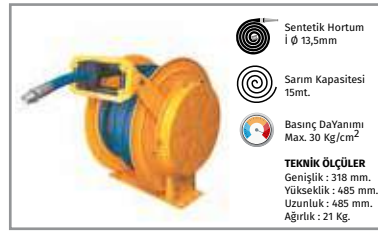

- Sentetik Hortum İØ 13,5mm
- Sarım Kapasitesi 15mt.
- Basınç Dayanımı Max. 30 Kg/cm<sup>2</sup>
- TEKNİK ÖLÇÜLER**  
Genişlik : 318 mm.  
Yükseklik : 485 mm.  
Uzunluk : 485 mm.  
Ağırlık : 21 Kg.

BHA-0433-0015



Hava Aktarım Tamburu

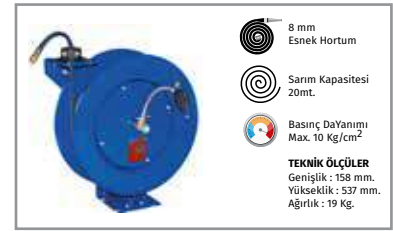

- 8 mm Esnek Hortum
- Sarım Kapasitesi 20mt.
- Basınç Dayanımı Max. 10 Kg/cm<sup>2</sup>
- TEKNİK ÖLÇÜLER**  
Genişlik : 158 mm.  
Yükseklik : 537 mm.  
Ağırlık : 19 Kg.

BHA-0233-0020



Poliüretan Hortumlu Hava Aktarım Tamburu



- Poliüretan Hortum İØ 6mm
- Sarım Kapasitesi 9mt.
- Basınç Dayanımı Max. 15 Kg/cm<sup>2</sup>
- TEKNİK ÖLÇÜLER**  
Genişlik : 140 mm.  
Yükseklik : 245 mm.  
Ağırlık : 4,5 Kg.

BHA-3113-0009



Poliüretan Hortumlu Hava Aktarım Tamburu



- Poliüretan Hortum İØ 8mm
- Sarım Kapasitesi 20mt.
- Basınç Dayanımı Max. 60 Kg/cm<sup>2</sup>
- TEKNİK ÖLÇÜLER**  
Genişlik : 177 mm.  
Yükseklik : 495 mm.  
Uzunluk : 486 mm.  
Ağırlık : 22 Kg.

BHA-0213-0020



Poliüretan Hortumlu Hava Aktarım Tamburu



- Poliüretan Hortum İØ 8mm
- Sarım Kapasitesi 20mt.
- Basınç Dayanımı Max. 15 Kg/cm<sup>2</sup>
- Sert plastik gövdeden üretilmiş olup hafiftir. Duvar, zemin, tavan gibi alanlara monte edilebilir. Özel yayılı otomatik geri toplama sistemlidir. Ağırlık 6 kg.

BHA-3213-0020



Otomatik Sarım Sistemli Su Aktarım Tamburları

| Ürün Kodu     | Açıklama   | IP   | Ad. | Fiyat     |
|---------------|--|------|-----|-----------|
| BSA-0223-0006 | DØ8mmx6,5m. PVC Hortumlu Su Püskürtme Tabancalı Su Aktarım Tamburu       | IP55 | 1   | 237,50 \$ |
| BSA-2433-0015 | İØ13mmx15m. Polipropilen Hor. Paslanmaz Çelik Gövdeli Su Aktarım Tamburu | IP55 | 1   | 750,00 \$ |
| BSA-0333-0020 | İØ9,5mmx20m. Sentetik Kauçuk Hortumlu Su Aktarım Tamburu                 | IP55 | 1   | 562,50 \$ |

Sulama Tamburu



- DØ 12mm Hortumlu
- Sarım Kapasitesi 6,5mt.
- Basınç Dayanımı Max. 7 Kg/cm<sup>2</sup>
- TEKNİK ÖLÇÜLER**  
Genişlik : 160 mm.  
Yükseklik : 360 mm.  
Ağırlık : 3,8 Kg.

BSA-0223-0006



Paslanmaz Gövdeli Su Aktarım Tamburu



- 13mm Hortum
- Sarım Kapasitesi 15mt.
- Basınç Dayanımı Max. 9 Kg/cm<sup>2</sup>
- TEKNİK ÖLÇÜLER**  
Genişlik : 285 mm.  
Yükseklik : 367 mm.  
Uzunluk : 367 mm.  
Ağırlık : 15 Kg.

BSA-2433-0015



Su Aktarım Tamburu



- 9,5mm çapında esnek hortumlu
- Sarım Kapasitesi 20mt.
- Basınç Dayanımı Max. 30 Kg/cm<sup>2</sup>
- TEKNİK ÖLÇÜLER**  
Genişlik : 158 mm.  
Yükseklik : 537 mm.  
Ağırlık : 19 Kg.

BSA-0333-0020



**Not:** Fiyatları döviz olan ürünlerde vade ve indirim uygulanmamaktadır. Teknik detaylara [www.bemis.com.tr](http://www.bemis.com.tr) web sitemizden ulaşabilirsiniz.

**Otomatik Sarım Sistemli Yağ ve Gres Aktarım Tamburları**

| Ürün Kodu     | Açıklama  | IP   | Ad. | Fiyat       |
|---------------|---|------|-----|-------------|
| BYA-3443-0010 | İØ13mmx10m. Kauçuk Hortumlu Hidrolik Yağ Aktarım Tamburu                  | IP55 | 1   | 625,00 \$   |
| BYA-0443-0020 | İØ13mmx20m. Kauçuk Hortumlu Hidrolik Yağ Aktarım Tamburu                  | IP55 | 1   | 937,50 \$   |
| BYA-0653-0015 | İØ6,3mmxDØ12,5mmx15m. İkiz Kauçuk Hor. Vinçler için Yağ ve Gres Akt. Tam. | IP55 | 1   | 1.562,50 \$ |
| BYA-0653-0020 | İØ6,3mmxDØ12,5mmx20m. İkiz Kauçuk Hor. Vinçler için Yağ ve Gres Akt. Tam. | IP55 | 1   | 1.750,00 \$ |

**Hidrolik Yağ Aktarım Tamburu**

**BYA-3443-0010**

**Hidrolik Yağ Aktarım Tamburu**

**BYA-0443-0020**

**Vinç Tamburu**
**Çift Hortumlu Yağ & Gres Aktarım Tamburu**

**BYA-0653-0020**

**Otomatik Sarım Sistemli Gaz Aktarım Tamburları**

| Ürün Kodu     | Açıklama  | IP   | Ad. | Fiyat     |
|---------------|---|------|-----|-----------|
| BGA-0741-0020 | İØ8mmxDØ16mmx20m. Kauçuk Hor. Oksijen ve Gaz için Çift Hor. Gaz Akt. Tam. | IP55 | 1   | 812,50 \$ |
| BGA-0743-0030 | İØ8mmxDØ16mmx30m. Kauçuk Hor. Oksijen ve Gaz için Çift Hor. Gaz Akt. Tam. | IP55 | 1   | 937,50 \$ |

**Gaz Aktarım Tamburu**

**BGA-0741-0020**

**Gaz Aktarım Tamburu**

**BGA-0743-0030**

**Not:** Fiyatları döviz olan ürünlerde vade ve indirim uygulanmamaktadır. Teknik detaylara [www.bemis.com.tr](http://www.bemis.com.tr) web sitemizden ulaşabilirsiniz.

# ÖRNEKTİR

|  |   |                                      |  |  |   |  |  |            |
|--|---|--------------------------------------|--|--|---|--|--|------------|
|          |   | <b>TAMBUR TALEP FORMU</b>            |  |  |   | FORM NUMARASI                                    | URT-FRM-010  |            |
|  |   |                                      |  |  |   | REVİZYON NUMARASI                                | 01   |            |
| <b>İLETİŞİM</b>  |   | Firma                                | <b>Talep Tarihi</b>  |  |   | REVİZYON TARİHİ                                  | -  |            |
|  |   | Adı Soyadı                           |  |  |   | İstenilen Teslim Süresi                          | YAYIN TARİHİ   | 10.12.2012 |
|  |   | Görevi                               |  |  |   | <b>Ürünün Kullanılacağı Saha / Proje / İhale</b> | SAYFA NUMARASI   | 1 / 2      |
|  |   | Telefon                              | <b>İstenilen Ürün Adedi</b>  |  |   |  |  |            |
|  |   | Faks                                 |  |  |   |  |  |            |
|  |   | Gsm                                  |  |  |   |  |  |            |
| e-posta  |   |                                      |  |  |   |  |  |            |
| <b>ÜRÜN TEKNİK ÖZELLİKLERİ</b>   |   |                                      |  |  |   |  |  |            |
| <b>Gövde</b>   | Ürün Tipi   | <input type="checkbox"/> A Tipi      | <input type="checkbox"/> B Tipi                                    | <input type="checkbox"/> C Tipi                                  | <input type="checkbox"/> D Tipi                               | <input type="checkbox"/> E Tipi                  | <input type="checkbox"/> F Tipi                                |            |
|  | * (Listeden Seçin)  | <input type="checkbox"/> G Tipi      | <input type="checkbox"/> H Tipi                                    | <input type="checkbox"/> K Tipi                                  | <input type="checkbox"/> M Tipi                               | <input type="checkbox"/> N Tipi                  | <input type="checkbox"/> P Tipi                                |            |
|  | Fireleme  | <input type="checkbox"/> Kilitlemeli | <input type="checkbox"/> Kilitlemesiz                              |  |   |  |  |            |
|  | Sarım Tipi  | <input type="checkbox"/> El ile      | <input type="checkbox"/> Yay ile                                   | Çalışma Şekli  |   | <input type="checkbox"/> Yatay                   | <input type="checkbox"/> Dikey                                 |            |
|  | Koruma Sınıfı   | IP 54                                | Boya Rengi   | <input type="checkbox"/> Standart Sarı                           | <input type="checkbox"/> RAL .....                            |  |  |            |
| Dönüş Yönü   | <input type="checkbox"/> Sol Tarafa   |                                      | <input type="checkbox"/> Sağ Tarafa                                |  | <input type="checkbox"/> Her İki Yöne                         |  |  |            |
| <b>Uygulama</b>  | Montaj Yeri   | <input type="checkbox"/> Tavan       | <input type="checkbox"/> Zemin                                     | <input type="checkbox"/> Duvar                                   | <input type="checkbox"/> Diğer .....                          |  |  |            |
|  | Kullanım Yeri   | <input type="checkbox"/> İç Mekan    | <input type="checkbox"/> Dış Mekan                                 | <input type="checkbox"/> Hareketli                               | <input type="checkbox"/> Hareketsiz                           | <input type="checkbox"/> Diğer                   |  |            |
|  | Ortam Şartları  | <input type="checkbox"/> Toz         | <input type="checkbox"/> Fazla                                     | <input type="checkbox"/> Az                                      | Nem Oranı   | <input type="checkbox"/> Yüksek                  | <input type="checkbox"/> Düşük                                 |            |
|  | Ürünün Kullanılacağı Yerin Tanımını Yapınız                                   |                                      |  |  |   | Montaj Yerinin Yerden Yüksekliği                 |  |            |
|  |   |                                      |  |  |   | ..... metre                                      | <input type="checkbox"/> Araç Üstüne                           |            |
| <b>Kablo</b>   | Kablo Tipi  | <input type="checkbox"/> Yuvarlak    | <input type="checkbox"/> Yassı                                     | <input type="checkbox"/> Kablosuz                                | Akım Türü   | <input type="checkbox"/> AC                      | <input type="checkbox"/> DC                                    |            |
|  | Akım / Voltaj   | AC ..... Amper / ..... Volt          |  |  | DC ..... Amper / ..... Volt                                   |  |  |            |
|  | Kablo Özelliği  |                                      |  |  |   |  |  |            |
|  | Kablo Markası   | <input type="checkbox"/> Yerli       | <input type="checkbox"/> Yabancı                                   | <input type="checkbox"/> Farketmez                               | <input type="checkbox"/> TSE li                               | <input type="checkbox"/> Diğer                   |  |            |
|  | Kablo Uzunluğu  | <input type="checkbox"/> 15 m        | <input type="checkbox"/> 20 m                                      | <input type="checkbox"/> 25 m                                    | <input type="checkbox"/> 40 m                                 | <input type="checkbox"/> 50 m                    | <input type="checkbox"/>                                       |            |
|  | Kablo Ucu   | Kablo ucu boş bırakılsın             |  |  | Kablo ucuna uygun priz takılsın                               |  |  |            |
| <b>Açıklan</b>   | Ürün veya Proje Hakkında Talep Edilen Farklı Detaylar Varsa Lütfen Belirtiniz |                                      |  |  |   |  |  |            |
|  |   |                                      |  |  |   |  |  |            |
| <b>GÖVDE BÖLÜMÜNDEKİ ÜRÜN TİPİ MODELİNİ AŞAĞIDAKİ LİSTEYE GÖRE SEÇEREK İŞARETLEYİNİZ</b> |   |                                      |  |  |   |  |  |            |
| <b>ÜRÜN TİPİ LİSTESİ</b>   | <b>Hareketli Tambur</b>   |                                      |  | <b>Sabit Tambur</b>  |   |  |  |            |
|  | <b>A</b> Yatay Kullanım İçin Taşıyıcıya Monteli                               |                                      |  | <b>G</b> Yatay Kullanım İçin Zemine Monteli                      |   |  |  |            |
|  | <b>B</b> Havada Yatay Kullanım İçin Taşıyıcıya Monteli                        |                                      |  | <b>H</b> Havadan ve Üstten Sarımlı Duvara Monteli                |   |  |  |            |
|  | <b>C</b> Dikey Kullanım İçin Taşıyıcıya Monteli (aşağı hareketli)             |                                      | <b>D</b> Dikey Kullanım İçin Taşıyıcıya Monteli (yukarı hareketli) |  | <b>K</b> Dikey Kullanım İçin Zemine Monteli (Aşağı Hareketli) |  | <b>M</b> Dikey Kullanım İçin Duvara Monteli (Yukarı Hareketli) |            |
|  | <b>E</b> Yatay Kullanım İçin Taşıyıcıya Monteli, Merkezden Beslemeli          |                                      |  | <b>N</b> Yatay Kullanım İçin Zemine Monteli, Merkezden Beslemeli |   |  |  |            |
|  | <b>F</b> Yatay Kullanım İçin Taşıyıcıya Monteli                               |                                      |  | <b>P</b> Zemine Monteli  |   |  |  |            |

**Bu bilgiler doğrultusunda sipariş alınmalı ve bu form müşteriye doldurturmalı. Not: Bu formu web sitemizden veya müşteri temsilcimizden temin edebilirsiniz.**

| Ürün Kodu          | Açıklama  | Kutu | Koli | Fiyat       |
|--------------------|---|------|------|-------------|
| BAK-1000-0001      | CEE Norm 3-4/32A. Fiş Kapağı (IP67 Fiş Koruma Kapağı)     | 5    | 90   | 107,00 TL   |
| BAK-1000-0002      | CEE Norm 5/32A. Fiş Kapağı (IP67 Fiş Koruma Kapağı)       | 5    | 90   | 107,00 TL   |
| BAK-1000-0003      | CEE Norm 63A. Fiş Kapağı (IP67 Fiş Koruma Kapağı)         | 5    | 90   | 137,00 TL   |
| BAK-1000-0004      | CEE Norm 125A. Fiş Kapağı (IP67 Fiş Koruma Kapağı)        | 5    | 90   | 214,00 TL   |
| BAK-1000-0008      | 1/16A. 220V. Fiş Kapağı (IP67 Fiş Koruma Kapağı)          | 5    | 90   | 88,00 TL    |
| BAK-1000-0010      | CEE Norm 3/16A. 220V. Fiş Kapağı (IP67 Fiş Koruma Kapağı) | 5    | 90   | 88,00 TL    |
| BAK-1000-0011      | CEE Norm 4/16A. 380V. Fiş Kapağı (IP67 Fiş Koruma Kapağı) | 5    | 90   | 88,00 TL    |
| BAK-1000-0012      | CEE Norm 5/16A. 380V. Fiş Kapağı (IP67 Fiş Koruma Kapağı) | 5    | 90   | 107,00 TL   |
| BAK-1100-0010      | 3/16A. 90 Eğik Duvar Fiş Yaylı Kapak                      |      |      | 93,00 TL    |
| BAK-1100-0011      | 4/16A. 90 Eğik Duvar Fiş Yaylı Kapak                      |      |      | 117,00 TL   |
| BAK-1100-0012      | 5/16A. 90 Eğik Duvar Fiş Yaylı Kapak                      |      |      | 117,00 TL   |
| BAK-1100-0013      | 3/4/5/32A. 90 Eğik Duvar Fiş Yaylı Kapak                  |      |      | 140,00 TL   |
| BAK-2000-0100      | 75x75 Çerçeve ve Contası                                  |      |      | 64,00 TL    |
| BAK-2000-0200      | 83x90 Çerçeve ve Contası                                  |      |      | 69,00 TL    |
| BAK-2000-0500      | 1/16A Pano Priz Vidalama Plastiği                         |      |      | 25,00 TL    |
| BAK-2000-0501      | 75x75 Çerçevesel Makine Priz Montaj Aparatı               |      |      | 35,00 TL    |
| BAK-2000-1007      | 1/16A. 220V. IP67 Fiş/Priz Kapak Bağı                     | 10   | 180  | 49,00 TL    |
| BAK-2100-0000      | 125A. 90 Eğik Duvar Prizi Klemens Taşıyıcı                |      |      | 635,00 TL   |
| BAK-3000-1000      | V5 Kombinasyon Şeffaf Sigorta Kapağı                      |      |      | 107,00 TL   |
| BAK-3000-1070      | V7 Kombinasyon Şeffaf Sigorta Kapağı                      |      |      | 127,00 TL   |
| BAK-3000-2000      | V10 Kombinasyon Şeffaf Sigorta Kapağı                     |      |      | 146,00 TL   |
| BAK-3000-2020      | V12 Kombinasyon Şeffaf Sigorta Kapağı                     |      |      | 176,00 TL   |
| BAK-3000-3000      | V17 Kombinasyon Şeffaf Sigorta Kapağı                     |      |      | 205,00 TL   |
| BAK-3000-5000      | V26 Kombinasyon Şeffaf Sigorta Kapağı                     |      |      | 244,00 TL   |
| BAK-3007-0000      | Kombinasyon Klemens Tutucu                                |      |      | 96,00 TL    |
| BAK-5001-0000      | Kablo Taşıyıcılar için 1/16A. 220V. 4'lü Priz             |      |      | 477,00 TL   |
| BAK-5004-0000      | Kablo Taşıyıcılar için kulaklı kapak                      |      |      | 78,00 TL    |
| BAK-5005-0001      | Kablo Taşıyıcılar için Elcik (Çap 19mm)                   |      |      | 69,00 TL    |
| BAK-5005-0002      | Kablo Taşıyıcılar için Elcik (Çap 21mm)                   |      |      | 78,00 TL    |
| BAK-5009-0000      | 1/16A 3 Ad. ( 3 Nolu Makara Göbek)                        | 4    |      | 579,00 TL   |
| BAK-6000-0300      | 75x75 Polybox Delikli Çerçeve                             |      |      | 64,00 TL    |
| BAK-6000-0400      | 75x75 Polybox Deliksiz Çerçeve                            |      |      | 64,00 TL    |
| BAK-6000-0500      | Polybox Metal Askı  |      |      | 39,00 TL    |
| yeni BAK-3000-8000 | 8'li Sigorta Modülü                                       |      |      | 607,00 TL   |
| yeni BAK-3000-9000 | 12'li Sigorta Modülü                                      |      |      | 852,00 TL   |
| yeni BAK-5000-0000 | Kombinasyon Arabası                                       |      |      | 2.661,00 TL |

yeni  
yeni  
yeni



BAK-3000-8000  
8'li Sigorta Modülü



BAK-3000-9000  
12'li Sigorta Modülü



BAK-2000-0500  
1/16A Pano Priz  
Vidalama Plastiği



Kombinasyon Şeffaf Kapakları



BAK-3007-0000  
Kombinasyon Klemens  
Tutucu



Eğik Duvar Fiş  
Yaylı Kapak



Kablo Taşıyıcı  
(Makara) Elçiği



IP67 Fiş Koruma  
Kapağı



BAK-5001-0000  
Kablo Taşıyıcı (Makara)  
4'lü Priz Göbeği



BAK-2100-0000  
125A. 90 Eğik Duvar Priz  
Klemens Taşıyıcı



100  
yüzde  
yerli...

**B** bemis

Yedek Parça

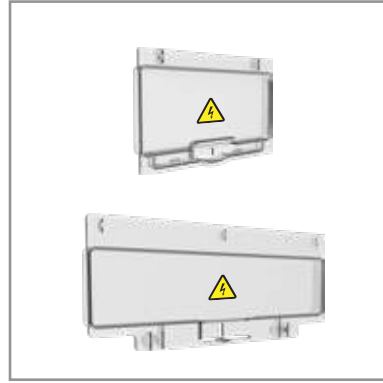

Üreten Ülke Güçlüdür

## PATENTLİ ÜRÜNLERİMİZ

Somunlu Pano Prizi  
Tescil No: 2021/012911



Cee Norm Eğik Döner Fiş Serisi  
Tescil No: 2015/08133

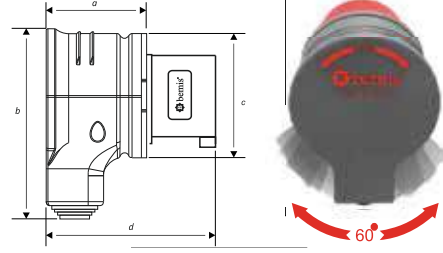

1/16A. 220V. IP68 Fiş Priz Serisi  
Tescil No: 2015/04906

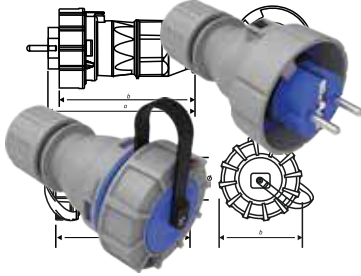

Cee Norm Grup Priz Serisi  
Tescil No: 2015/04907

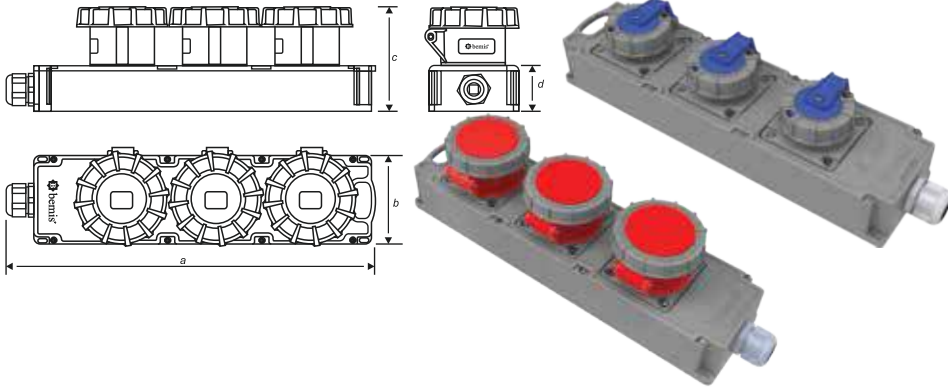

Cee Norm Poly Box Serisi  
Tescil No: 2015/04907



## PATENTLİ ÜRÜNLERİMİZ

### 1/16A. 220V. Kauçuk Fiş & Priz

Tescil No: 2006 00105



### 24V. AC İzole Trafo Serisi

Tescil No: 2006 00105



### Aydınlatma El Lambası

Tescil No: 2001 01497



### Somunlu Priz Serisi

Tescil No: 2013 15191



IEC 60309'a göre endüstriyel fiş ve priz standartları çizelgesi ve renk tablosu

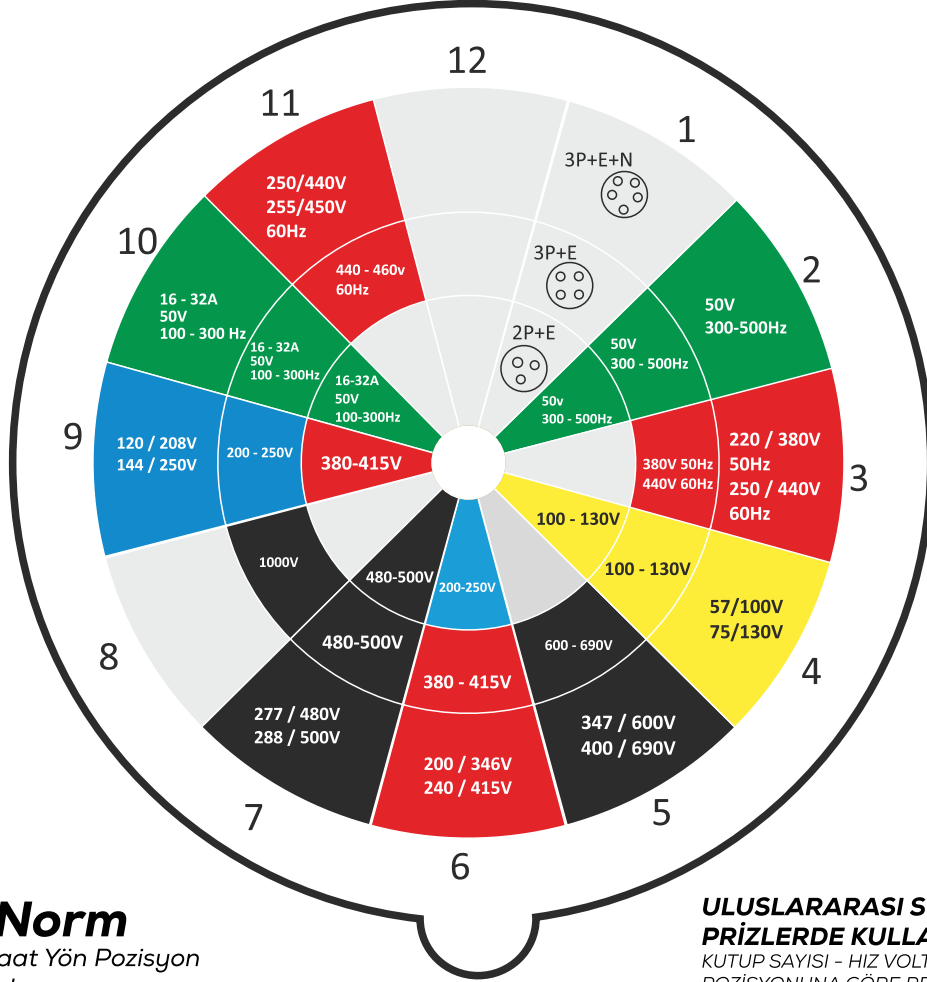

**CEE Norm**

Renk ve Saat Yön Pozisyon  
Teknik Çizelge

**ULUSLARARASI STANDARTLARINDA  
PRİZLERDE KULLANILAN ÇİZELGE**



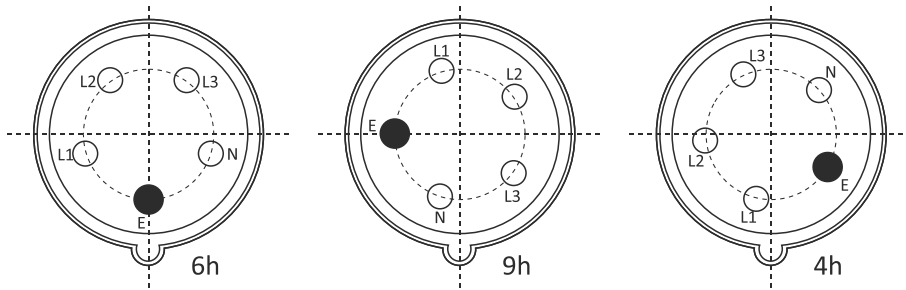







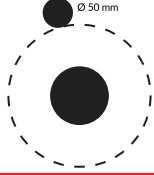
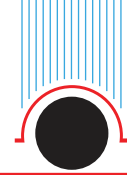
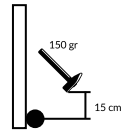
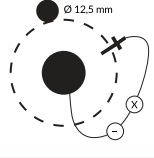
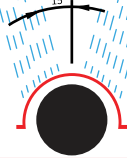
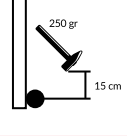
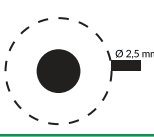
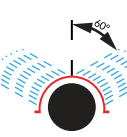

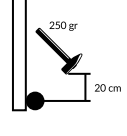
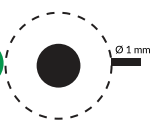

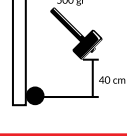
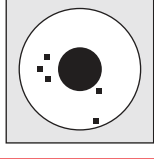

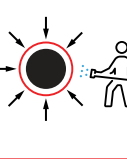

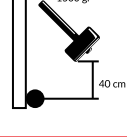
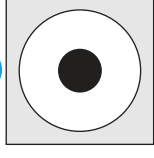
KUTUP SAYISI - HIZ VOLTAJ - AMPER SAAT YÖN  
POZİSYONUNA GÖRE RENK KODLARI

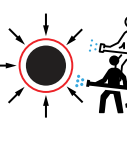

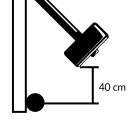
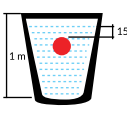
Prizin önden görünüşüne göre topraklama kontağı pozisyonları

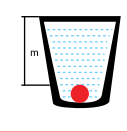

## IP KORUMA SINIFI TABLOSU VE ÖRNEK AÇIKLAMA

| Kati Cisimlere Karşı Koruma  |  | Suya Karşı Koruma |   | Darbe Karşı Koruma   |   |
|--|--|-------------------|---|--|---|
| 0  | Korumasız  | 0                 | Korumasız   | 0  | Korumasız   |
| 1  |  Elin tersi ile temasa ve çapı 50 mm'den büyük kati cisimlere karşı koruma  | 1                 |  Düşey olarak akan su damllarına karşı koruma  | 1  |  Darbe Şiddeti 0,225 jul |
| 2  |  Parmak ile temasa ve çapı 12 mm'den büyük kati cisimlere karşı korumalı  | 2                 |  Her iki yönden 15°'lik açıyla düşen (sıçrayan) suya karşı korumalı  | 2  |  Darbe Şiddeti 0,375 jul |
| 3  |  Çapı 2,5 mm'den büyük kati cisimlere karşı korumalı  | 3                 |  Her iki yönden 60°'lik açıyla düşen (sıçrayan) suya karşı korumalı<br>Sembol:                          | 3  |  Darbe Şiddeti 0,500 jul |
| 4  |  Çapı 1 mm'den büyük granül halindeki kati cisimlere karşı korumalı   | 4                 |  Tüm yönlerden sıçrayan suya karşı korumalı<br>Sembol:    | 5  |  Darbe Şiddeti 2 jul   |
| 5  |  İnsan temasına karşı tam korumalı. Toza karşı zararsız koruma<br>Sembol:  | 5                 |  Tüm yönlerden gelen su jetine karşı korumalı<br>Sembol:    | 7  |  Darbe Şiddeti 6 jul   |
| 6  |  İnsan temasına karşı ve toza karşı tam koruma<br>Sembol:                  | 6                 |  Tüm yönlerden gelen (deniz dalgasına eşdeğer) yüksek basınçlı su jetine karşı korumalı<br>Sembol:  | 9  |  Darbe Şiddeti 20 jul  |
| İmalatlarımızda yukarıdaki koruma sınıfları göz önüne alınarak IP değerleri verilmiştir. |  | 7                 |  Geçici olarak suya daldırıldığında<br>Sembol:    | Örnek 1:<br><b>IP 44</b> <br>Çapı 1 mm'den büyük kati cisimlere ve tüm yönlerden sıçrayan suya karşı korumalı   |   |
|  |  | 8                 |  Kalıcı olarak suya daldırıldığında<br>Sembol:    | Örnek 2:<br><b>IP 55</b>  <br>İnsan temasına, toza ve tüm yönlerden gelen su jetine karşı korumalı |   |

IP 44

IP 67

## SEMBOLLERİN AÇIKLAMALARI

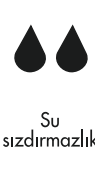

## KONTAKTÖR, KONDANSATÖR VE PRİZ SEÇİM TABLOSU

| MOTOR ANMA GÜCÜ |     | ANMA AKIMI   | SIEMENS |         |  |                             | KONTAKTÖRE GÖRE KONDANSATÖR SEÇİMİ | YEDEK KONTAK YAPISI |
|-----------------|-----|--------------|---------|---------|---|-----------------------------|------------------------------------|---------------------|
| KW              | HP  | AC 2-3 380 V | A       | TIP     | A   | TIP                         | AMP/KVAR                           | S O                 |
| 3               | 4   | 6.6          |         |         |   |                             | 1                                  |                     |
| 4               | 5.4 | 8.5          | 9       | 3 TF 40 | 9   | BC1-1505-2011/BC1-1505-2535 | 1.5                                | 1 + 1               |
| 5.5             | 7.5 | 11.5         | 12      | 3 TF 41 | 12  | BC1-1505-2011/BC1-1505-2535 | 2                                  | 1 + 1               |
| 7.5             | 10  | 15.5         | 16      | 3 TF 42 | 16  | BC1-1505-2011/BC1-1505-2535 | 4                                  | 1 + 1               |
| 11              | 15  | 22.5         | 22      | 3 TF 43 | 22  | BC1-3505-2011/BC1-3505-2420 | 5                                  | 1 + 1<br>2 + 2      |
| 15              | 20  | 30           | 32      | 3 TF 44 | 32  | BC1-3505-2011/BC1-3505-2420 | 6                                  | 2 + 2               |
| 18.5            | 25  | 36           | 40      | 3 TF 45 | 40  | BC1-4505-2011/BC1-4505-2420 | 6                                  | 2 + 2               |
| 22              | 30  | 43           | 45      | 3 TF 46 | 45  | BC1-4505-2011/BC1-4505-2420 | 8                                  | 2 + 2               |
| 30.5            | 40  | 57           | 63      | 3 TF 47 | 63  | BC1-4505-2011/BC1-4505-2420 | 15                                 | 2 + 2               |
| 37              | 50  | 72           | 75      | 3 TF 48 | 80  | BC1-6505-7011/BC1-6505-7413 | 15                                 | 2 + 2               |
| 45              | 60  | 85           | 85      | 3 TF 49 | 95  | BC1-6505-7011/BC1-6505-7413 | 15                                 | 2 + 2               |
| 55              | 75  | 104          | 110     | 3 TF 50 | 125   | BC1-6505-7011/BC1-6505-7413 | 20                                 | 2 + 2               |
| 75              | 100 | 142          | 140     | 3 TF 51 |   | BC1-6505-7011/BC1-6505-7413 | 25                                 | 2 + 2               |
| 90              | 125 | 169          | 170     | 3 TF 52 | 170   |                             | 30                                 | 2 + 2               |
| 110             | 150 | 204          | 205     | 3 TF 53 |   |                             | 40                                 | 2 + 2               |
| 132             | 180 | 243          | 250     | 3 TF 54 | 245   |                             | 45                                 | 2 + 2               |

**0,6/1 kV Yalıtımlı Kabloların Standart Güçlerini Taşıyabilecek Maksimum Uzaklık**

| Kesit<br>mm <sup>2</sup><br>Güç<br>(kW) | 1,5   | 2,5 | 4   | 6   | 10  | 16   | 25   | 35   | 50   | 70   | 95   | 120  | 150  | 185  | 240  | 300  |      |
|---|-------|-----|-----|-----|-----|------|------|------|------|------|------|------|------|------|------|------|------|
|   | Metre |     |     |     |     |      |      |      |      |      |      |      |      |      |      |      |      |
| 2,5                                     | 103   | 169 | 271 | 404 | 675 | 1063 |      |      |      |      |      |      |      |      |      |      |      |
| 3                                       | 87    | 142 | 227 | 339 | 567 | 892  | 1391 |      |      |      |      |      |      |      |      |      |      |
| 3,5                                     | 73    | 120 | 192 | 287 | 480 | 756  | 1180 |      |      |      |      |      |      |      |      |      |      |
| 4                                       | 65    | 106 | 169 | 253 | 423 | 666  | 1038 | 1266 |      |      |      |      |      |      |      |      |      |
| 5                                       | 51    | 84  | 135 | 202 | 337 | 531  | 828  | 1130 |      |      |      |      |      |      |      |      |      |
| 6                                       | 43    | 70  | 112 | 168 | 280 | 442  | 689  | 940  | 1247 |      |      |      |      |      |      |      |      |
| 7                                       | 36    | 60  | 96  | 143 | 240 | 378  | 590  | 805  | 1067 |      |      |      |      |      |      |      |      |
| 8                                       | 32    | 52  | 84  | 125 | 210 | 330  | 515  | 703  | 932  | 1301 |      |      |      |      |      |      |      |
| 9                                       | 28    | 46  | 74  | 111 | 186 | 293  | 457  | 625  | 828  | 1155 |      |      |      |      |      |      |      |
| 10                                      | 25    | 42  | 67  | 101 | 168 | 265  | 414  | 565  | 750  | 1045 |      |      |      |      |      |      |      |
| 12                                      | 21    | 35  | 56  | 84  | 141 | 223  | 347  | 474  | 630  | 878  | 1168 |      |      |      |      |      |      |
| 14                                      | 18    | 30  | 49  | 73  | 123 | 194  | 302  | 413  | 547  | 764  | 1014 |      |      |      |      |      |      |
| 16                                      |       | 26  | 42  | 62  | 105 | 165  | 257  | 351  | 466  | 650  | 863  |      |      |      |      |      |      |
| 18                                      |       | 23  | 37  | 56  | 94  | 148  | 231  | 316  | 419  | 585  | 777  | 1053 |      |      |      |      |      |
| 20                                      |       | 21  | 34  | 51  | 85  | 135  | 210  | 287  | 381  | 532  | 706  | 948  | 1119 |      |      |      |      |
| 22                                      |       |     | 30  | 45  | 76  | 120  | 288  | 256  | 340  | 475  | 630  | 862  | 1017 |      |      |      |      |
| 25                                      |       |     | 27  | 40  | 67  | 106  | 165  | 226  | 299  | 418  | 555  | 769  | 907  | 1072 |      |      |      |
| 30                                      |       |     |     | 33  | 56  | 89   | 139  | 186  | 251  | 351  | 466  | 669  | 828  | 944  | 1156 |      |      |
| 35                                      |       |     |     |     | 48  | 75   | 117  | 161  | 213  | 297  | 395  | 569  | 732  | 907  | 1119 | 1124 |      |
| 40                                      |       |     |     |     | 42  | 66   | 103  | 141  | 187  | 262  | 348  | 482  | 622  | 799  | 971  | 1124 | 952  |
| 45                                      |       |     |     |     |     | 58   | 91   | 124  | 165  | 231  | 306  | 425  | 569  | 732  | 907  | 1119 | 1124 |
| 50                                      |       |     |     |     |     | 53   | 82   | 113  | 149  | 209  | 277  | 388  | 500  | 672  | 823  | 971  | 1124 |
| 55                                      |       |     |     |     |     | 48   | 74   | 102  | 135  | 188  | 250  | 305  | 426  | 522  | 639  | 739  | 838  |
| 60                                      |       |     |     |     |     |      | 68   | 94   | 124  | 173  | 230  | 305  | 426  | 522  | 639  | 739  | 838  |
| 70                                      |       |     |     |     |     |      | 58   | 80   | 106  | 148  | 197  | 241  | 336  | 411  | 511  | 611  | 711  |
| 75                                      |       |     |     |     |     |      | 55   | 75   | 99   | 139  | 185  | 225  | 314  | 385  | 466  | 547  | 628  |
| 80                                      |       |     |     |     |     |      |      | 70   | 93   | 130  | 172  | 210  | 293  | 360  | 441  | 522  | 603  |
| 90                                      |       |     |     |     |     |      |      | 62   | 82   | 115  | 153  | 187  | 261  | 319  | 390  | 471  | 552  |
| 100                                     |       |     |     |     |     |      |      |      | 74   | 103  | 138  | 168  | 234  | 287  | 358  | 429  | 500  |
| 110                                     |       |     |     |     |     |      |      |      | 68   | 94   | 126  | 153  | 214  | 262  | 333  | 404  | 475  |
| 130                                     |       |     |     |     |     |      |      |      |      | 80   | 106  | 129  | 177  | 216  | 265  | 314  | 363  |
| 133                                     |       |     |     |     |     |      |      |      |      | 78   | 104  | 127  | 177  | 216  | 265  | 314  | 363  |
| 150                                     |       |     |     |     |     |      |      |      |      |      | 92   | 112  | 156  | 192  | 222  | 262  | 303  |
| 160                                     |       |     |     |     |     |      |      |      |      |      | 86   | 105  | 146  | 179  | 208  | 245  | 282  |
| 180                                     |       |     |     |     |     |      |      |      |      |      |      | 93   | 110  | 130  | 160  | 185  | 210  |
| 200                                     |       |     |     |     |     |      |      |      |      |      |      |      | 99   | 117  | 144  | 166  | 188  |
| 205                                     |       |     |     |     |     |      |      |      |      |      |      |      | 97   | 114  | 140  | 162  | 184  |
| 230                                     |       |     |     |     |     |      |      |      |      |      |      |      |      | 102  | 125  | 145  | 167  |
| 270                                     |       |     |     |     |     |      |      |      |      |      |      |      |      |      |      |      | 123  |
| 280                                     |       |     |     |     |     |      |      |      |      |      |      |      |      |      |      |      | 119  |
| 290                                     |       |     |     |     |     |      |      |      |      |      |      |      |      |      |      |      | 114  |
| 300                                     |       |     |     |     |     |      |      |      |      |      |      |      |      |      |      |      | 111  |
| 305                                     |       |     |     |     |     |      |      |      |      |      |      |      |      |      |      |      | 109  |

Cosφ = 0,9 olarak alınmıştır

380V Gerilim Düşümü %3

**Motor Gücüne Göre Sigorta ve Kablo Seçimi**

| Motor Anma Gücü | kW   | HP   | Cosφ | Verim % | 220V             |            |      | Motor Anma Akımı | Sigortalar       |            | Bağlantı Kablosu NYY NYCY mm2 |     |
|-----------------|------|------|------|---------|------------------|------------|------|------------------|------------------|------------|-------------------------------|-----|
|                 |      |      |      |         | Motor Anma Akımı | Sigortalar |      |                  | Motor Anma Akımı | Sigortalar |                               |     |
|                 |      |      |      |         |                  | Direkt     | Y/▲  |                  |                  | Direkt     |                               | Y/▲ |
| A               | A    | A    | A    | A       | A                | A          | A    | A                |                  |            |                               |     |
| 0,25            | 0,34 | 0,7  | 62   | 1,4     | 4                | 2          | 0,8  | 2                | 2                | 4X2,5      |                               |     |
| 0,37            | 0,5  | 0,72 | 64   | 2,1     | 4                | 2          | 1,6  | 4                | 2                | 4X2,5      |                               |     |
| 0,55            | 0,75 | 0,75 | 69   | 2,7     | 4                | 4          | 1,6  | 4                | 2                | 4X2,5      |                               |     |
| 0,75            | 1    | 0,8  | 74   | 5,4     | 6                | 1          | 2    | 4                | 4                | 4X2,5      |                               |     |
| 1,1             | 1,5  | 0,8  | 77   | 4,4     | 6                | 6          | 2,5  | 4                | 4                | 4X2,5      |                               |     |
| 1,5             | 2    | 0,83 | 78   | 6       | 16               | 10         | 3,5  | 6                | 6                | 4X2,5      |                               |     |
| 2,2             | 3    | 0,84 | 81   | 8,7     | 20               | 16         | 5    | 10               | 6                | 4X2,5      |                               |     |
| 3               | 4    | 0,84 | 81   | 11,5    | 20               | 16         | 6,6  | 16               | 10               | 4X2,5      |                               |     |
| 4               | 5,4  | 0,84 | 82   | 14,7    | 25               | 20         | 8,5  | 20               | 16               | 4X2,5      |                               |     |
| 5,5             | 7,5  | 0,85 | 83   | 19,8    | 35               | 25         | 11,5 | 25               | 20               | 4X2,5      |                               |     |
| 7,5             | 10   | 0,86 | 85   | 26,5    | 50               | 35         | 15,5 | 35               | 25               | 4X4        |                               |     |
| 11              | 15   | 0,86 | 87   | 39      | 63               | 50         | 22,5 | 35               | 35               | 4X6        |                               |     |
| 15              | 20   | 0,86 | 87   | 52      | 50               | 63         | 30   | 50               | 35               | 4X6        |                               |     |
| 18,5            | 25   | 0,86 | 88   | 62      | 100              | 80         | 36   | 63               | 50               | 4X10       |                               |     |
| 22              | 30   | 0,87 | 89   | 74      | 100              | 80         | 43   | 63               | 50               | 4X10       |                               |     |
| 30              | 40   | 0,87 | 90   | 98      | 125              | 100        | 57   | 80               | 63               | 4X16       |                               |     |
| 37              | 50   | 0,87 | 90   | 124     | 200              | 160        | 72   | 100              | 80               | 3X25+16    |                               |     |
| 45              | 61   | 0,88 | 91   | 147     | 225              | 200        | 85   | 125              | 100              | 3X35+16    |                               |     |
| 55              | 75   | 0,88 | 91   | 180     | 250              | 225        | 104  | 60               | 125              | 3X50+25    |                               |     |
| 75              | 100  | 0,88 | 91   | 246     | 350              | 250        | 142  | 200              | 160              | 3X70+35    |                               |     |
| 90              | 123  | 0,88 | 92   | -       | -                | -          | 169  | 225              | 200              | 3X95+50    |                               |     |
| 110             | 150  | 0,88 | 92   | -       | -                | -          | 204  | 250              | 225              | 3X120+70   |                               |     |
| 132             | 180  | 0,88 | 92   | -       | -                | -          | 243  | 300              | 250              | 3X120+70   |                               |     |



Kombinasyon Kod Sistemi

## BH4-6330-2010

| KOMBİNASYON SERİSİ İÇİN KODLAMA SİSTEMİ |     |           |            |            |            |   |                |    |  |   |
|---|-----|-----------|------------|------------|------------|---|----------------|----|--|---|
| BH4                                     | -   | 6         | 3          | 30         | 2          | 01  | 2              |    |  |   |
| Ürün Grubu                              | -   | IP Sınıfı | Priz Adeti | Priz Cinsi | Priz Adeti | Priz Cinsi                                    | Yan Priz Adeti |    |  |   |
| BD1                                     | V5  | -         | 1          | 20         | 0          | Prizsiz                                       | 0              | 01 | 16A IP67 Makine Priz                       | 0 |
| BH1                                     | V5  | -         | 2          | 44         | 1          | 01 Delikli                                    | 1              | 02 | Cee Norm 3/16A 2P+E 6h IP67 Makine Priz    | 1 |
| BD2                                     | V10 | -         | 3          | 54         | 2          | 02 16A IP67 Makine Priz                       | 2              | 03 | Cee Norm 3/16A 2P+E 4h IP67 Makine Priz    | 2 |
| BH2                                     | V10 | -         | 4          | 55         | 3          | 03 Cee Norm 3/16A 2P+E 6h IP67 Makine Priz    | 3              | 04 | Cee Norm 3/16A 2P+E 2h IP67 Makine Priz    | 3 |
| BD3                                     | V24 | -         | 5          | 65         | 4          | 04 Cee Norm 3/16A 2P+E 4h IP67 Makine Priz    | 4              | 05 | Cee Norm 3/16A 2P+E 9h IP67 Makine Priz    | 4 |
| BH3                                     | V24 | -         | 6          | 66         | 5          | 05 Cee Norm 3/16A 2P+E 2h IP67 Makine Priz    | 5              | 06 | Cee Norm 3/16A 2P+E 7h IP67 Makine Priz    | 5 |
| BD4                                     | V17 | -         | 7          | 67         | 6          | 06 Cee Norm 3/16A 2P+E 9h IP67 Makine Priz    | 6              | 07 | Cee Norm 4/16A 3P+E 6h IP67 Makine Priz    | 6 |
| BH4                                     | V17 | -         | 8          | 68         | 7          | 07 Cee Norm 3/16A 2P+E 7h IP67 Makine Priz    | 7              | 08 | Cee Norm 4/16A 3P+E 4h IP67 Makine Priz    | 7 |
|   |     | -         | 9          |            | 8          | 08 Cee Norm 4/16A 3P+E 6h IP67 Makine Priz    | 8              | 09 | Cee Norm 4/16A 3P+E 2h IP67 Makine Priz    | 8 |
|   |     | -         | 0          |            | 9          | 09 Cee Norm 4/16A 3P+E 4h IP67 Makine Priz    | 9              | 10 | Cee Norm 4/16A 3P+E 9h IP67 Makine Priz    | 9 |
|   |     | -         |            |            | 10         | 10 Cee Norm 4/16A 3P+E 2h IP67 Makine Priz    |                | 11 | Cee Norm 4/16A 3P+E 10h IP67 Makine Priz   |   |
|   |     | -         |            |            | 11         | 11 Cee Norm 4/16A 3P+E 9h IP67 Makine Priz    |                | 12 | Cee Norm 4/16A 3P+E 7h IP67 Makine Priz    |   |
|   |     | -         |            |            | 12         | 12 Cee Norm 4/16A 3P+E 10h IP67 Makine Priz   |                | 13 | Cee Norm 5/16A 3P+E+N 6h IP67 Somunlu Priz |   |
|   |     | -         |            |            | 13         | 13 Cee Norm 4/16A 3P+E 7h IP67 Makine Priz    |                | 14 | Cee Norm 5/16A 3P+E+N 4h IP67 Somunlu Priz |   |
|   |     | -         |            |            | 14         | 14 Cee Norm 5/16A 3P+E+N 6h IP67 Somunlu Priz |                | 15 | Cee Norm 5/16A 3P+E+N 2h IP67 Somunlu Priz |   |
|   |     | -         |            |            | 15         | 15 Cee Norm 5/16A 3P+E+N 4h IP67 Somunlu Priz |                | 16 | Cee Norm 5/16A 3P+E+N 9h IP67 Somunlu Priz |   |
|   |     | -         |            |            | 16         | 16 Cee Norm 5/16A 3P+E+N 2h IP67 Somunlu Priz |                | 17 | Cee Norm 5/16A 3P+E+N 7h IP67 Somunlu Priz |   |
|   |     | -         |            |            | 17         | 17 Cee Norm 5/16A 3P+E+N 9h IP67 Somunlu Priz |                | 18 | Cee Norm 3/32A 2P+E 6h IP67 Somunlu Priz   |   |
|   |     | -         |            |            | 18         | 18 Cee Norm 5/16A 3P+E+N 7h IP67 Somunlu Priz |                | 19 | Cee Norm 3/32A 2P+E 4h IP67 Somunlu Priz   |   |
|   |     | -         |            |            | 19         | 19 Cee Norm 3/32A 2P+E 6h IP67 Somunlu Priz   |                | 20 | Cee Norm 3/32A 2P+E 2h IP67 Somunlu Priz   |   |

Fiş Priz Kod Sistemi



CEE Norm Serisi  
16 Amper  
220 Volt  
3 Kutuplu  
IP 44  
Düz Fiş  
1. Ürün

## BC1-1403-2011

| BC1           |                                    | 1     | 4         | 03           | 2  | 01        | 1       |   |                     |
|---------------|------------------------------------|-------|-----------|--------------|----|-----------|---------|---|---------------------|
| Ürün Grupları |                                    | Amper | Volt      | Kutup Sayısı | IP | Tanımlama | Ürün No |   |                     |
| BK1           | Monofaze Fiş Priz Serisi           | 16    | 12        | 0            | 02 | 20 1      | 1       | 1 | Uzatma Düz Fiş      |
| BS1           | Monofaze Sızdırmaz Fiş Priz Serisi | 32    | 20-25V.   | 1            | 03 | 44 2      | 2       | 2 | Uzatma Eğik Fiş     |
| BK6           | Trifaze Kauçuk Fiş Priz Serisi     | 63    | 40.50V.   | 2            | 04 | 54 3      | 3       | 3 | UPS Düz Fiş         |
| BK4           | Kaynak Ark Fiş Priz Serisi         | 125   | 110-130V. | 3            | 05 | 55 4      | 4       | 4 | UPS Eğik Fiş        |
| BC1           | Cee Norm Fiş Priz Serisi           | 160   | 220-240V. | 4            | 06 | 65 5      | 5       | 5 | Makine Fişi         |
| BR1           | Ray Priz Serisi                    | 200   | 380-415V. | 5            | 07 | 66 6      | 6       | 6 | Makine Fişi 45 Eğik |
| BP1           | Monofaze Plastik Fiş Priz Serisi   | 400   | 500V.     | 6            | 08 | 67 7      | 7       | 8 | Somunlu Fiş         |



## DİŐ TİCARET

Dünya pazarında marka olma yolunda emin adımlarla ilerleyen Bemis Elektrik, 63 Ülkeye yaptığı ihracatı, 2024 yılı itibari ile 70 Ülkeye ihracat olarak hedeflemiştir.

Bemis ürünleri, distribütörler, acenteler ve Bemis showroamları vasıtasıyla global pazardaki kullanıcıları ile buluşmaktadır.

Katıldığı uluslararası fuarlar ve tanıtım faaliyetleri ile Bemis'in dünyada marka bilinirliğini artması yönünde çalışmalarını sürdürmektedir.



### Bemis Avrupa Şubesi



### Dış Ticaret Departmanı

+90 542 773 72 94

+90 224 363 30 65

trade@bemis.com.tr

www.bemis.com.tr



## MERKEZ

+90 533 956 25 46  
satis@bemis.com.tr

## MARMARA BÖLGESİ - 1

+90 549 839 13 34  
marmara@bemis.com.tr

## MARMARA BÖLGESİ - 2

+90 549 804 85 99  
marmara1@bemis.com.tr

## BURSA BÖLGESİ

+90 549 797 10 42  
buygun@bemis.com.tr

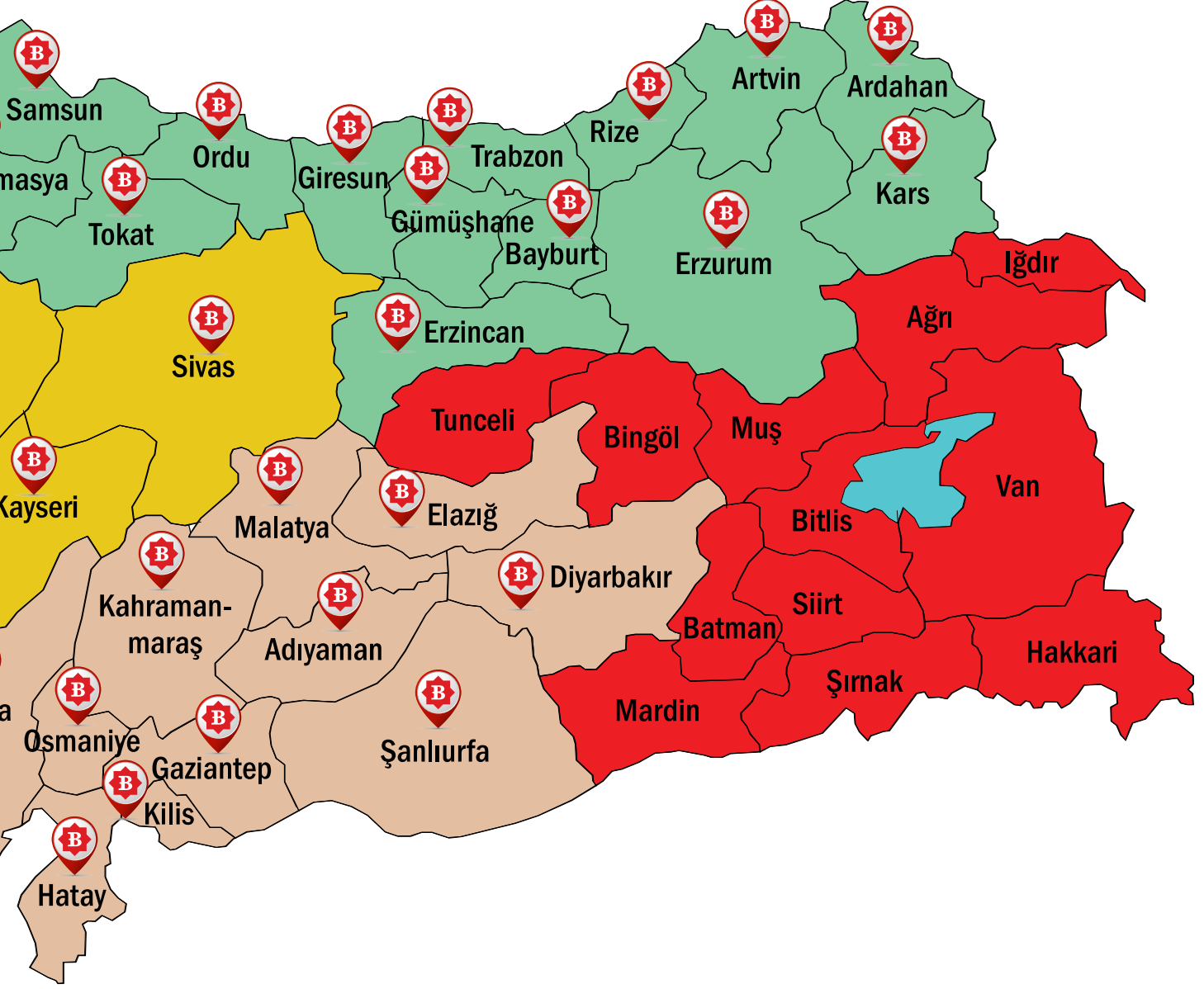

#### EGE AKDENİZ BÖLGESİ

+90 530 875 30 92  
ege@bemis.com.tr

#### İÇ ANADOLU BÖLGESİ

+90 549 839 13 36  
mcanak@bemis.com.tr

#### KARADENİZ BÖLGESİ

+90 533 140 13 64  
tbesli@bemis.com.tr

#### GÜNEYDOĞU BÖLGESİ

+90 549 797 10 45  
guneydogu@bemis.com.tr



## Doğa'ya saygı Doğa'ya saygı respect for nature



GES (Güneş Enerji Sistemi) elektrik üretimi



ECO enerji tüketimi, led aydınlatma ve gün ışığından yararlanma sistemi



ECO su tüketimi yağmur suyu geri kazanımı ve eco musluk kullanımı



Ağaçlandırmaya destek.



Geri dönüşümlü hammadde kullanımı ve geri kazanım sistemi



Atık kontrolü ve minimum atık sistemi Bemis firmasında uygulanmaktadır.



Fiş & priz geri dönüşüm projesi

### Adres:

Bursa Organize San. Böl.  
Yeşil Cad. No:19 NİLÜFER/BURSA

### Telefon:

+90 224 363 30 65  
+90 533 956 25 47

### Mail:

info@bemis.com.tr  
satis@bemis.com.tr

### Web:

www.bemis.com.tr