

2023

İZOLATÖRLER



KLEMENSLER



TARAK İZOLATÖR- BARA TUTUCU

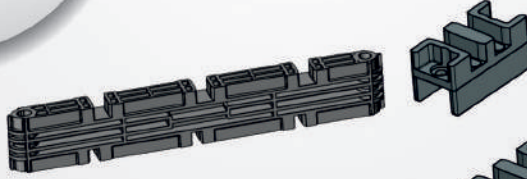

İZOLATÖRLER



TOPRAKLAMA
KLEMENSLERİ

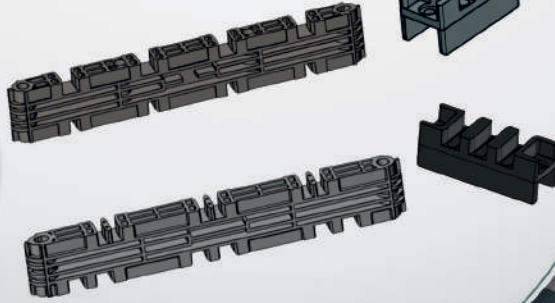

TARAK
İZOLATÖRLER

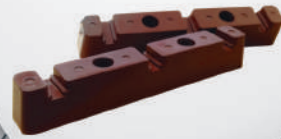

DELİKLİ SAC RAYLAR
EŞ POTANSİYEL BARALAR

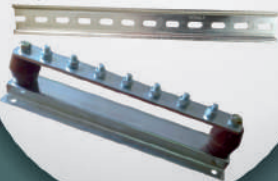

TARAK
İZOLATÖRLER



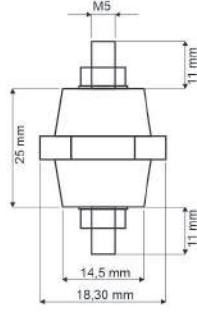
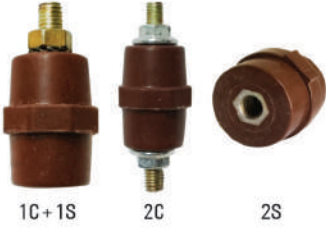

M5 MİNİ İZOLATÖR 25MM

KOD	AÇIKLAMA	KOLİ AD.	KUTU AD.	FİYAT \$
57219	BMI-M 5/2C	1500	250	0,3650 \$
57220	BMI-M 5/1C + 1S	1500	250	0,4640 \$
57221	BMI-M 5/2S	1500	250	0,5725 \$

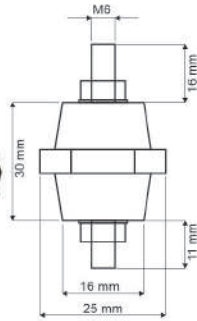

M6 MİNİ BOY FIÇI İZOLATÖR 30MM

KOD	AÇIKLAMA	KOLİ AD.	KUTU AD.	FİYAT \$
57222	BMI-M 6/2 C	900	150	0,4235 \$
57223	BMI-M 6/1 C + 1 S	900	150	0,5035 \$
57224	BMI-M 6/2 S	900	150	0,6000 \$

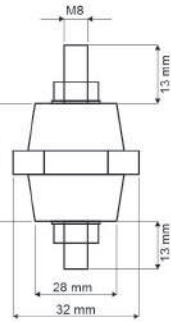
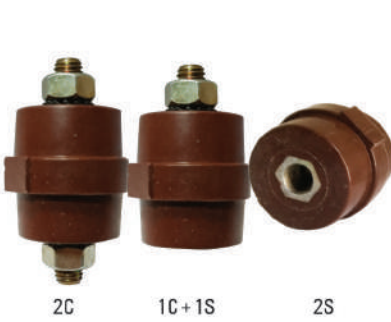

M8 ORTA BOY FIÇI İZOLATÖR 35MM

KOD	AÇIKLAMA	KOLİ AD.	KUTU AD.	FİYAT \$
57236	BMI-M 8/2 C	400	50	0,6810 \$
57237	BMI-M 8/1 C + 1 S	400	50	0,7350 \$
57238	BMI-M 8/2 S	400	50	0,7780 \$

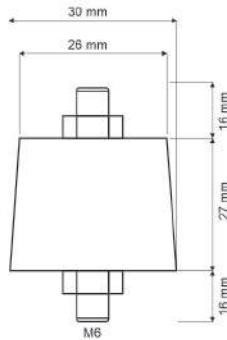
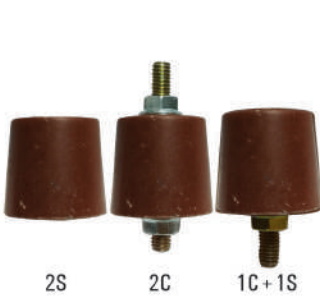

M6 ORTA BOY KONİK İZOLATÖR

KOD	AÇIKLAMA	KOLİ AD.	KUTU AD.	FİYAT \$
57225	BMI-M 6/2 C	600	100	0,4470 \$
57226	BMI-M 6/1 C + 1 S	600	100	0,5510 \$
57227	BMI-M 6/2 S	600	100	0,6522 \$

- 2c : İki tarafı civatalı izolatör
- 1c + 1s : Bir tarafı civatalı bir tarafı kör somunlu izolatör
- 2s : İki tarafı kör somunlu izolatör

40mm BÜYÜK BOY FIÇI İZOLATÖR (M8)

KOD	AÇIKLAMA	KOLİ AD.	KUTU AD.	FİYAT \$
57228	BMI-M 8/2C	240	40	0,940 \$
57232	BMI-M 8/1C + 1S	240	40	1,000 \$
57230	BMI-M 8/2S	240	40	1,010 \$

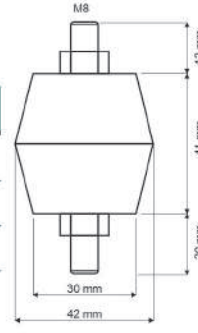

40mm BÜYÜK BOY FIÇI İZOLATÖR (M10)

KOD	AÇIKLAMA	KOLİ AD.	KUTU AD.	FİYAT \$
57229	BMI-M 10/2 C	240	40	1,200 \$
57233	BMI-M 10/1 C + 1 S	240	40	1,140 \$
57231	BMI-M 10/2 S	240	40	1,170 \$

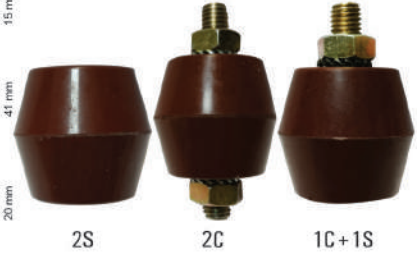
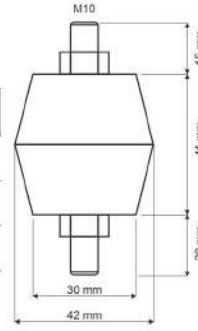

50mm BÜYÜK BOY FIÇI İZOLATÖR

KOD	AÇIKLAMA	KOLİ AD.	KUTU AD.	FİYAT \$
57241	BMI-M 10/2 C	120	20	1,640 \$
57242	BMI-M 10/1 C + 1 S	120	20	1,510 \$
57243	BMI-M 10/2 S	120	20	1,360 \$

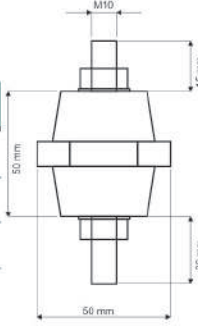

BARA TUTUCU SERFİL

SAÇ KALINLIĞI 5MM

KOD	AÇIKLAMA	KOLİ AD.	KUTU AD.	FİYAT \$
57240	BMS (M 8 - M 10)	300	50	0,920 \$



İZOLATÖRLERİMİZDE KULLANDIĞIMIZ CİVATA ve SOMUNLAR

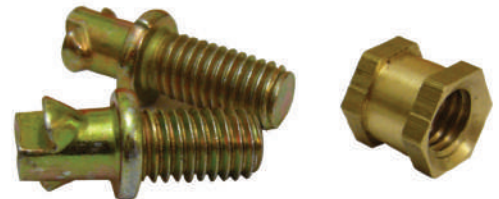

- 2c : İki tarafı civatalı izolatör
- 1c + 1s : Bir tarafı civatalı bir tarafı kör somunlu izolatör
- 2s : İki tarafı kör somunlu izolatör

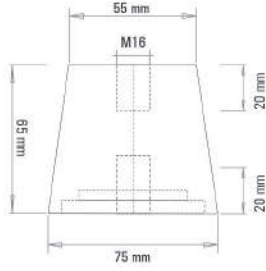

1NK İZOLATÖR

KOD	AÇIKLAMA	KOLİ AD.	KUTU AD.	FİYAT \$
57264	1NK-500 İzolatör M16 (Tepe Kuvveti 500 Kg.)	72	12	3,300 \$

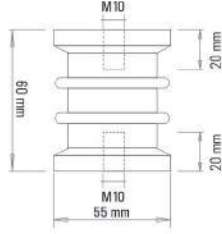

1N-500 İZOLATÖRLER

KOD	AÇIKLAMA	KOLİ AD.	KUTU AD.	FİYAT \$
57265	1N-500 Mesnet İzolatörü (M10)	120	20	1,915 \$
57266	1N-500 Mesnet İzolatörü (M12)	120	20	2,340 \$

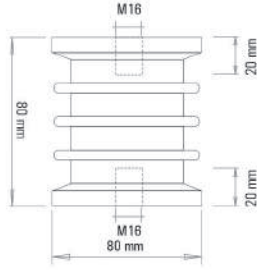

1N-1000 İZOLATÖRLER

KOD	AÇIKLAMA	KOLİ AD.	KUTU AD.	FİYAT \$
57267	1N-1000 Mesnet İzolatörü (M12)	40	20	5,000 \$
57268	1N-1000 Mesnet İzolatörü (M16)	40	20	6,000 \$

USD

KOD	AÇIKLAMA	KOLİ AD.	KUTU AD.	FİYAT AD. \$
H7021	3F x 2F Tarak İzolatör(siyah)	240	40	1,800 \$

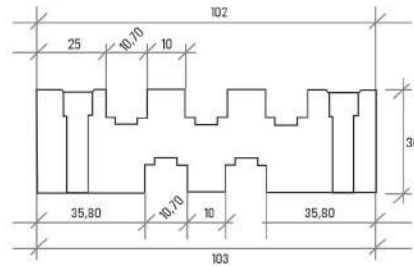

USD

KOD	AÇIKLAMA	KUTU AD.	FİYAT AD. \$
H7037	4 X 1F	12	4,600 \$



TARAK İZOLATÖRLER

KOD	AÇIKLAMA	KOLİ AD.	KUTU AD.	FİYAT AD. \$
57244	3 x 1F Tarak İzolatör (KISA TİP)	120	20	1,120 \$

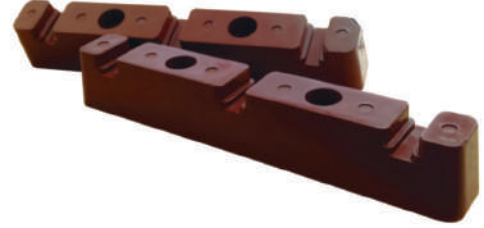
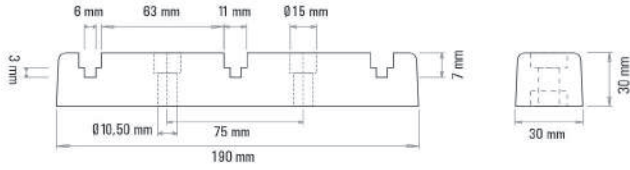

KOD	AÇIKLAMA	KOLİ AD.	KUTU AD.	FİYAT AD. \$
57245	3 x 1F Tarak İzolatör (UZUN TİP)	80	40	1,660 \$

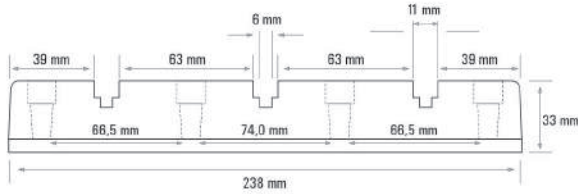

KOD	AÇIKLAMA	KOLİ AD.	KUTU AD.	FİYAT AD. \$
57246	3 x 2F Tarak İzolatör	80	40	1,560 \$

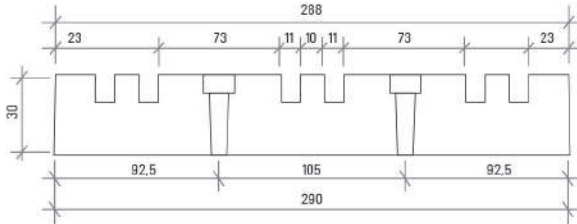

KOD	AÇIKLAMA	KOLİ AD.	KUTU AD.	FİYAT AD. \$
57247	3 x 1F + N (4x1F) Tarak İzolatör	80	40	1,665 \$

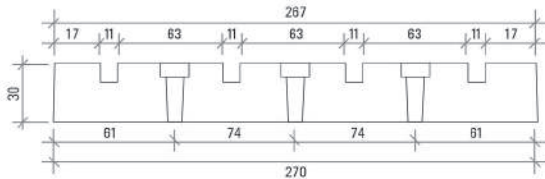

KOD	AÇIKLAMA	KOLİ AD.	KUTU AD.	FİYAT AD. \$
57248	3 x 2F + N Tarak İzolatör	72	8	2,250 \$

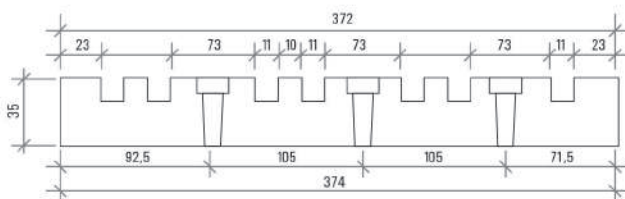

TARAK İZOLATÖRLER

*%70 POLYAMİD %30 CAM ELYAF KATKILIDIR.

KÜÇÜK

KOD	AÇIKLAMA	KOLİ AD.	KUTU AD.	FİYAT AD. \$
H7018	3 x 1F Tarak İzolatör (siyah)	180	30	2,200 \$

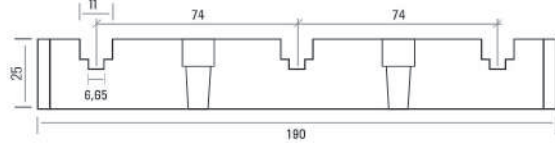

BÜYÜK

USD

KOD	AÇIKLAMA	KOLİ AD.	KUTU AD.	FİYAT AD. \$
H7020	3 x 1F Tarak İzolatör (siyah)	132	22	3,600 \$

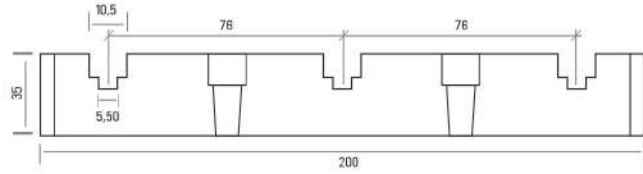

USD

KOD	AÇIKLAMA	KOLİ AD.	KUTU AD.	FİYAT AD. \$
H7019	3 x 2F Tarak İzolatör (siyah)	100	50	4,000 \$

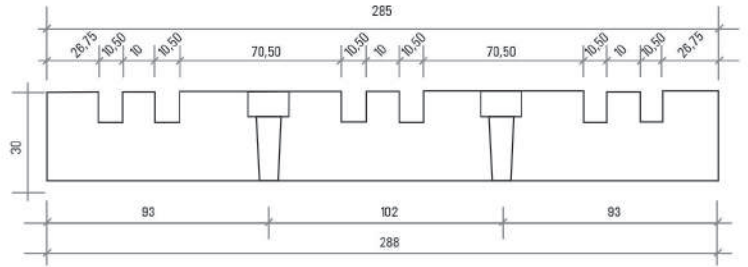

TARAK İZOLATÖRLER

KOD	AÇIKLAMA	KOLİ AD.	FİYAT AD. \$
H7013	3 x 1F (5 mm -10 mm) Çift Taraflı Tarak İzolatör	100	3,200 \$

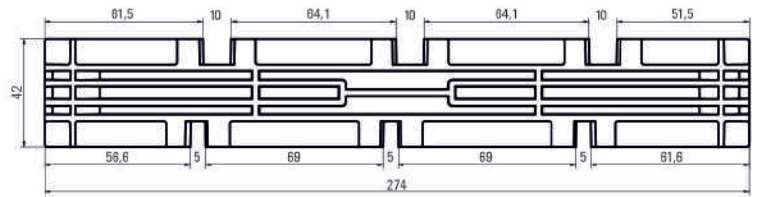

KOD	AÇIKLAMA	KOLİ AD.	FİYAT AD. \$
H7028	3 x 2F (5 mm -10 mm) Çift Taraflı Tarak İzolatör	100	3,200 \$

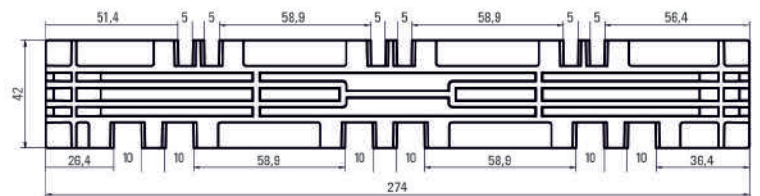

KOD	AÇIKLAMA	KOLİ AD.	FİYAT AD. \$
H7041	3 x 1F+N (5 mm - 10 mm) Çift Taraflı Tarak İzolatör	100	3,200 \$

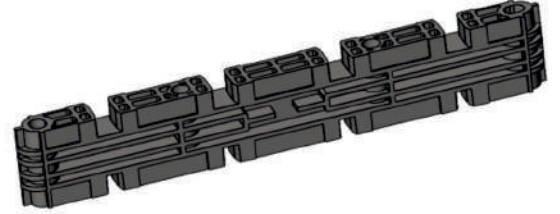
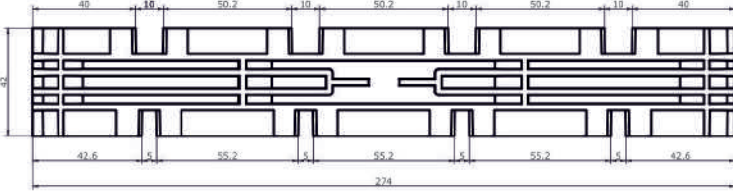

KOD	AÇIKLAMA	KOLİ AD.	FİYAT AD. \$
H7042	1 x 2F (10 mm) Geçmeli Bara Tutucu	100	1,200 \$

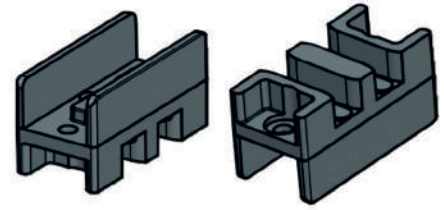
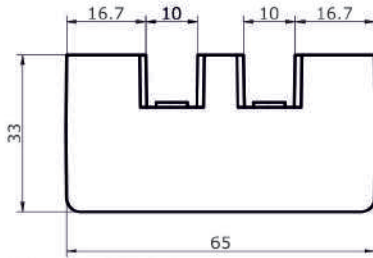

*%70 POLYAMİD %30 CAM ELYAF KATKILIDIR.

KOD	AÇIKLAMA	KOLİ AD.	FİYAT AD. \$
H7043	1 x 2F (5 mm) Geçmeli Bara Tutucu	100	1,200 \$

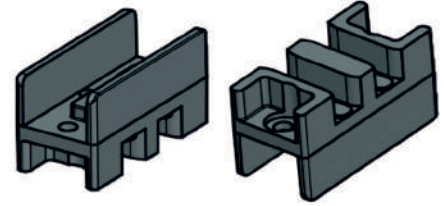
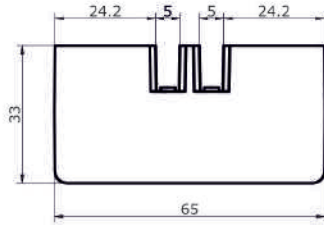

*%70 POLYAMİD %30 CAM ELYAF KATKILIDIR.

KOD	AÇIKLAMA	KOLİ AD.	FİYAT AD. \$
H7044	1 x 3F (10 mm) Geçmeli Bara Tutucu	100	1,400 \$

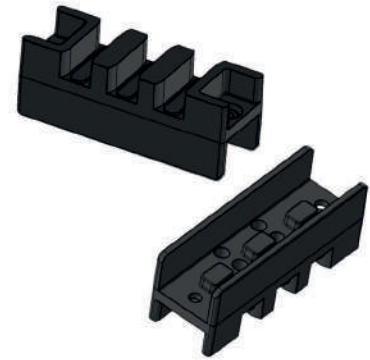
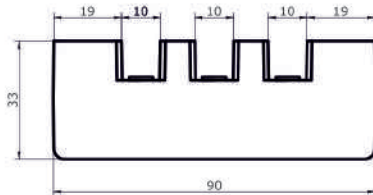

*%70 POLYAMİD %30 CAM ELYAF KATKILIDIR.

KOD	AÇIKLAMA	KOLİ AD.	FİYAT AD. \$
H7045	1 x 3F (5 mm) Geçmeli Bara Tutucu	100	1,250 \$

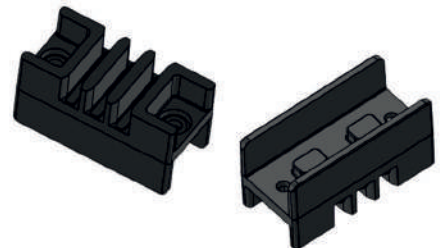
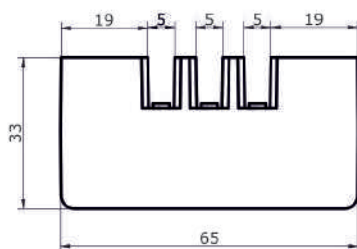

*%70 POLYAMİD %30 CAM ELYAF KATKILIDIR.



BAKIR SIKMALI EK MUFLAR

KOD	KESİT mm ²	KUTU AD.	FİYAT \$
57087	16	250	0,2926 \$
57088	25	250	0,5500 \$
57089	35	200	0,7235 \$
57090	50	150	0,9276 \$
57091	70	100	1,5460 \$
57092	95	50	1,7872 \$
57093	120	50	2,5766 \$
57094	150	40	3,8830 \$
57095	185	30	4,8086 \$
57096	240	25	6,8724 \$



ALÜMİNYUM SIKMALI EK MUFLAR

KOD	KESİT mm ²	KUTU AD.	FİYAT \$
82970	16	200	0,2468 \$
82971	25	125	0,3660 \$
82972	35	100	0,5352 \$
82973	50	75	0,7298 \$
82974	70	50	0,9064 \$
82975	95	40	1,3628 \$
82976	120	25	1,4106 \$
82977	150	20	2,2564 \$
82978	185	15	2,5180 \$
82979	240	15	2,7756 \$



U KLEMENSLER

KOD	AÇIKLAMA	KUTU AD.	FİYAT \$
57022	16'lik U Klemens	100	1,1000 \$
57023	25'lik U Klemens	100	1,4200 \$
57024	35'lik U Klemens	75	1,6450 \$
57025	50'lik U Klemens	50	2,4200 \$
57026	70'lik U Klemens	40	2,7074 \$
57027	95'lik U Klemens	25	3,9000 \$
57028	120'lik U Klemens	20	4,6300 \$
57029	150'lik U Klemens	15	6,7600 \$



TIRNAKLI KLEMENSLER

KOD	AÇIKLAMA	KUTU AD.	FİYAT \$
57040	No:1 16 mm ²	150	0,8900 \$
57041	No:2 25 mm ²	100	1,1600 \$
57042	No:3 35 mm ²	100	1,6300 \$
57043	No:4 50 mm ²	50	2,4500 \$
57044	No:5 70 mm ²	50	3,2000 \$
57045	No:6-7 95 mm ²	25	6,7500 \$

ALÜMİNYUM SKP

KOD	KESİT	DELİK ÇAPİ	İÇ ÇAP	DIŞ ÇAP	UZUNLUK	KUTU AD.	FİYAT \$
62970	16'lık	6	5,6	10	60	200	0,2468 \$
62971	25'lik	8	7	12	70	150	0,3660 \$
62972	35'lik	8	8,2	14	76	100	0,5352 \$
62973	50'lik	10	10	16	83	75	0,7298 \$
62974	70'lik	12	11,40	18	97	50	0,9064 \$
62975	95'lik	12	13,40	22	109	50	1,3628 \$
62976	120'lik	12	15	22	109	40	1,4106 \$
62977	150'lik	12	16,50	26	118,5	25	2,2564 \$
62978	185'lik	12	18,50	28	125,5	20	2,5180 \$
62979	240'lık	12	21,2	32	141,5	20	2,7756 \$



AL-CU SKP

KOD	KESİT	DELİK ÇAPİ	İÇ ÇAP	DIŞ ÇAP	UZUNLUK	KUTU AD.	FİYAT \$
72981	16'lık	6	5,6	10	60	200	0,5852 \$
72982	25'lik	8	7	12	70	150	0,7000 \$
72983	35'lik	8	8,2	14	76	100	0,8648 \$
72984	50'lik	10	10	16	83	75	1,0555 \$
72985	70'lik	12	11,40	18	97	50	1,2266 \$
72986	95'lik	12	13,40	22	109	50	2,2000 \$
72987	120'lik	12	15	22	109	40	2,3600 \$
72988	150'lik	12	16,50	26	118,5	25	3,7170 \$
72989	185'lik	12	18,50	28	125,5	20	3,7870 \$
72990	240'lık	12	21,2	32	141,5	20	3,9224 \$



İTHAL AL-CU KABLO PABUCU

KOD	KUTU AD.	KABLO KESİTİ	METRİK(mm ²)	BİRİM FİYAT \$
92970	80	SC 16-8	M8	3,2500 \$
92971	80	SC 25-8	M8	3,2500 \$
92972	40	SC 35-8	M8	3,2500 \$
92973	40	SC 50-10	M10	4,3600 \$
92974	40	SC 70-10	M10	4,3600 \$
92975	40	SC 95-12	M12	4,3600 \$
92976	20	SC 120-12	M12	7,8000 \$
92977	20	SC 150-12	M12	7,8000 \$
92978	16	SC 185-16	M16	13,000 \$
92979	16	SC 240-16	M16	13,000 \$



İTHAL AL-CU SKP'LER İÇİN (Z) BAĞLANTI APARATI

KOD	AÇIKLAMA	KUTU AD.	BİRİM FİYAT \$
52980	Al-Cu Skp'ler İçin Bağlantı Aparatı	100	2,1280 \$



DÜZ SAC RAYLAR**35x7,5**

KOD	AÇIKLAMA	UZUNLUK	KOLİ AD.	FİYAT \$
52902	Düz Sac Ray	30 cm	50	0,4300 \$
52901	Düz Sac Ray	1m.	50	1,2800 \$
52911	Düz Sac Ray	2m.	50	2,5600 \$

DELİKLİ SAC RAYLAR**35x7,5**

KOD	AÇIKLAMA	UZUNLUK	KOLİ AD.	FİYAT \$
52904	Delikli Sac Ray	30 cm	50	0,4300 \$
52903	Delikli Sac Ray	1m.	50	1,2800 \$
52913	Delikli Sac Ray	2m.	50	2,5600 \$

**SAC RAY TAŞIYICI**

KOD	AÇIKLAMA	KOLİ AD.	FİYAT \$
52956	Sac Ray Taşıyıcı	150	0,4300 \$

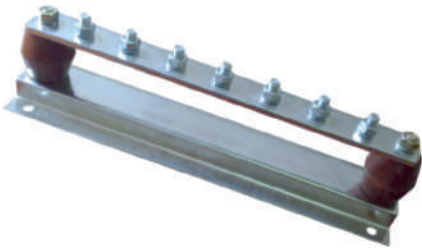
EŞ POTANSİYEL BARALAR

KOD	AÇIKLAMA	KUTU AD.	FİYAT \$
51001	30x3 21 cm 5 civatalı	1	12,890 \$
51003	30x3 25 cm 10 civatalı	1	14,865 \$
51005	30x3 30 cm 7 civatalı	1	16,200 \$
51007	30x3 40 cm 9 civatalı	1	21,400 \$
51009	30x3 50 cm 12 civatalı	1	27,000 \$
51012	30x5 21 cm 5 civatalı	1	18,310 \$
51013	30x5 25 cm 10 civatalı	1	20,820 \$
51014	30x5 30 cm 7 civatalı	1	22,770 \$
51016	30x5 40 cm 9 civatalı	1	30,360 \$
51018	30x5 50 cm 12 civatalı	1	37,350 \$
51020	40x5 21 cm 5 civatalı	1	21,650 \$
51022	40x5 30 cm 7 civatalı	1	29,000 \$
51024	40x5 40 cm 9 civatalı	1	38,100 \$
51026	40x5 50 cm 12 civatalı	1	47,000 \$

SKP KABLO PABUÇU TİP 1 Kalay Kaplamalı E-Bakır

KOD	KESİT mm ²	D	L	D1	D2	KUTU AD.	FİYAT \$
57172	16	M6	30	5,5	5,8	500	0,2575 \$
57173	25	M8	40	7	7,2	350	0,5160 \$
57174	35	M8	44	8,5	8,5	200	0,7042 \$
57175	50	M10	52	10	10	150	0,8620 \$
57176	70	M10	55	10	11,5	100	1,4468 \$
57177	95	M12	59	10	13,5	80	1,6702 \$
57178	120	M12	70	13	15,6	50	2,3032 \$
57179	150	M12	77	17	17	40	3,7766 \$
57180	185	M16	85	17	19	30	4,3618 \$
57181	240	M16	90	17	21	25	6,3830 \$

SKP KABLO PABUÇU TİP 2 (Uzun) Kalay Kaplamalı E-Bakır

KOD	KESİT mm ²	Civata	L	D1	D2	KUTU AD.	FİYAT \$
57071	10	M5	27,5	5	6,5	800	0,2766 \$
		M6	27,5	5	6,5	800	0,2926 \$
		M8	27,5	5	6,5	800	0,3230 \$
57072	16	M6	30	5,8	7,8	500	0,4128 \$
		M8	30	5,8	7,8	500	0,4468 \$
57073	25	M6	40	7,2	9,5	350	0,7554 \$
		M8	40	7,2	9,5	350	0,7074 \$
		M10	40	7,2	9,5	350	0,7554 \$
57074	35	M6	44	8,5	11	200	1,0200 \$
		M8	44	8,5	11	200	0,9788 \$
		M10	44	8,5	11	200	1,0130 \$
57075	50	M6	44	8,5	11	200	1,0630 \$
		M8	52	10	13	150	1,5808 \$
		M10	52	10	13	150	1,4600 \$
57076	70	M8	52	10	13	150	1,5320 \$
		M8	55	11,5	14,7	100	2,0800 \$
		M10	55	11,5	14,7	100	1,9256 \$
57077	95	M12	55	11,5	14,7	100	2,0000 \$
		M8	59	13,5	16,7	80	2,4040 \$
		M10	59	13,5	16,7	80	2,2660 \$
57078	120	M12	59	13,5	16,7	80	2,2660 \$
		M10	70	15,6	19	50	3,3350 \$
57079	150	M12	70	15,6	19	50	3,3297 \$
		M10	77	17	21	40	5,2120 \$
57080	185	M12	77	17	21	40	5,2120 \$
		M10	85	19	23	30	6,0400 \$
		M12	85	19	23	30	6,0000 \$
57081	240	M10	85	19	23	30	6,0000 \$
		M10	90	21	26	25	8,5000 \$
		M12	90	21	26	25	8,3200 \$
57082	300	M16	90	21	26	25	8,3200 \$
		M12	100	23,5	28,6	20	10,320 \$
		M16	100	23,5	28,6	20	10,320 \$
57083	400	M12	100	23,5	28,6	20	10,320 \$
		M12	108	26,8	32,8	12	17,000 \$
		M16	108	26,8	32,8	12	17,000 \$
		M20	108	26,8	32,8	12	18,700 \$

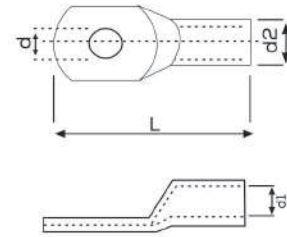



Elektrolitik Bakır,
Plastik Yan Kapaklı



Elektrolitik Bakır



Elektrolitik Bakır,
Nikel Kaplamalı Vidalar

TRİFAZE W OTOMAT BARASI

63A

KOD	AÇIKLAMA	MODÜL	KOLİ AD.	KUTU AD.	FİYAT \$
52940-Y	0,80 mm Elektrolitik Bakır 53 cm	10	150	25	10,4256 \$
52960-Y	0,80 mm Elektrolitik Bakır 106 cm	20	50	25	20,8500 \$

TRİFAZE W OTOMAT BARASI

80A

KOD	AÇIKLAMA	MODÜL	KOLİ AD.	KUTU AD.	FİYAT \$
52940	1 mm Elektrolitik Bakır 53 cm	10	150	25	17,0200 \$
52960	1 mm Elektrolitik Bakır 106 cm	20	50	25	34,0400 \$

TRİFAZE W OTOMAT BARASI

100A

KOD	AÇIKLAMA	MODÜL	KOLİ AD.	KUTU AD.	FİYAT \$
52941	1,5 mm Elektrolitik Bakır 53 cm	10	150	25	25,956 \$
52961	1,5 mm Elektrolitik Bakır 106 cm	20	50	25	51,912 \$
52966	Trifaze Bara Nihayet Kapağı				0,8086 \$

MONAFAZE W OTOMAT BARASI

KOD	AÇIKLAMA	MODÜL	KOLİ AD.	KUTU AD.	FİYAT \$
52943	1 mm Elektrolitik Bakır 53 cm	30	300	50	6,7021 \$
52963	1 mm Elektrolitik Bakır 100 cm	56	100	50	13,4040 \$
52942	1,5 mm Elektrolitik Bakır 53 cm	30	300	50	10,320 \$
52962	1,5 mm Elektrolitik Bakır 100 cm	56	100	50	20,640 \$

NÖTR TOPRAKLAMA BARASI

KOD	AÇIKLAMA	VİDA	KUTU AD.	FİYAT \$
52944	15 x 1,5 mm x 1 metre	31	20	17,022 \$
52948	15 x 1,5 mm x 1 metre	61	20	20,212 \$
52945	15 x 2 mm x 1 metre	31	20	21,064 \$
52949	15 x 2 mm x 1 metre	61	20	24,680 \$
52946	15 x 3 mm x 1 metre	31	20	30,000 \$
52947	15 x 3 mm x 1 metre	61	20	34,040 \$

PLASTİK SIRA KLEMENSLER

KOD	AÇIKLAMA	KUTU AD.	FİYAT \$
E 22010	No: 1 2.5-4 mm'lik	50	0,968 \$
E 22020	No: 2 4-6 mm'lik	50	1,150 \$
E 22030	No: 3 6-10 mm'lik	50	1,440 \$
E 22040	No: 4 10-16 mm'lik	50	1,800 \$
E 22050	No: 5 16-25 mm'lik	50	2,060 \$

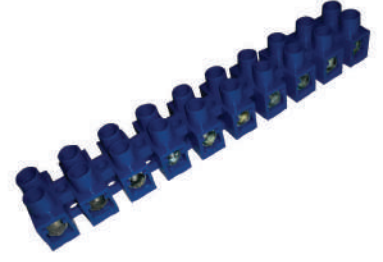

ISIYA DAYANIKLI SIRA KLEMENSLER

KOD	AÇIKLAMA	KUTU AD.	FİYAT \$
E 22110	No: 1 2.5-4 mm'lik	50	1,100 \$
E 22120	No: 2 4-6 mm'lik	50	1,300 \$
E 22130	No: 3 6-10 mm'lik	50	1,660 \$
E 22140	No: 4 10-16 mm'lik	50	2,000 \$
E 22150	No: 5 16-25 mm'lik	50	2,320 \$



AYAKSIZ - AYAKLI PANO TOPRAKLAMA KLEMENSLERİ

AYAKSIZ KOD	AYAKLI KOD	AÇIKLAMA	L	KOLİ AD.	FİYAT \$	80 Amp.
1206	1106	6 Delikli Klemensli	85	175	1,320 \$	
1207	1107	7 Delikli Klemensli	90	150	1,440 \$	
1210	1110	10 Delikli Klemensli	108	150	1,780 \$	
1212	1112	12 Delikli Klemensli	120	125	1,900 \$	
1215	1115	15 Delikli Klemensli	138	125	2,280 \$	
1220	1120	20 Delikli Klemensli	165	100	3,040 \$	
1225	1125	25 Delikli Klemensli	195	100	3,840 \$	
1230	1130	30 Delikli Klemensli	235	80	5,475 \$	

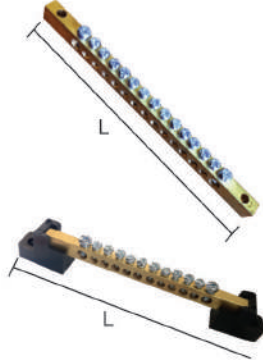

AYAKSIZ - AYAKLI PANO TOPRAKLAMA KLEMENSLERİ

AYAKSIZ KOD	AYAKLI KOD	AÇIKLAMA	L	KOLİ AD.	FİYAT \$	125 Amp.
1306A	1306	6 Delikli Klemensli	77	150	1,760 \$	
1307A	1307	7 Delikli Klemensli	87	150	1,870 \$	
1310A	1310	10 Delikli Klemensli	110	100	2,220 \$	
1312A	1312	12 Delikli Klemensli	124	100	2,660 \$	
1315A	1315	15 Delikli Klemensli	146	100	3,360 \$	
1320A	1320	20 Delikli Klemensli	182	100	4,200 \$	
1325A	1325	25 Delikli Klemensli	217	80	5,640 \$	
1330A	1330	30 Delikli Klemensli	265	75	7,580 \$	

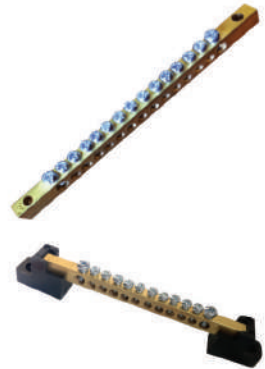

PANO TOPRAKLAMA KLEMENSLERİ AYAKSIZ

KOD	cinsi	L	FİYAT \$	63 Amp.
1004	4 Delikli Topraklama Klemens	33	0,560 \$	
1005	5 Delikli Topraklama Klemens	38	0,600 \$	
1006	6 Delikli Topraklama Klemens	45	0,800 \$	
1007	7 Delikli Topraklama Klemens	50	0,840 \$	
1009	9 Delikli Topraklama Klemens	62	0,960 \$	
1010	10 Delikli Topraklama Klemens	68	1,060 \$	
1012	12 Delikli Topraklama Klemens	80	1,360 \$	

PANO TOPRAKLAMA KLEMENSLERİ

1 metre boyunda

KOD	cinsi	L	KOLİ AD.	FİYAT \$
3388	6,5x9 mlz.	1 m.	20	33,700 \$
3389	7x12 mlz.	1 m.	20	38,900 \$





10 KABLO KESİTLİ 2 KUTUPLU DAĞITIM ÜNİTESİ (6,5x9 mm Kesit)

80 Amp.

KOD	AÇIKLAMA	L	B	H	KOLİ AD.	FİYAT \$
80-1407	2+5	63	45	47	22	5,770 \$
80-1410	2+8	83	45	47	15	6,480 \$
80-1412	2+10	94	45	47	14	7,060 \$
80-1415	2+13	110	45	47	12	9,420 \$
80-1420	2+18	140	45	47	6	12,200 \$
80-1422	2+20	151	45	47	6	12,840 \$



10 KABLO KESİTLİ 4 KUTUPLU DAĞITIM ÜNİTESİ (6,5x9 mm Kesit)

ALÇAK MODEL
80 Amp.

KOD	AÇIKLAMA	L	B	H	KOLİ AD.	FİYAT \$
80-1607	2+5	65	90	50	10	12,630 \$
80-1610	2+8	87	90	50	8	13,130 \$
80-1612	2+10	102	90	50	6	14,740 \$
80-1615	2+13	126	90	50	5	17,680 \$
80-1620	2+18	162	90	50	4	22,320 \$
80-1622	2+20	175	90	50	4	23,240 \$
80-1625	2+23	197	90	50	4	25,000 \$

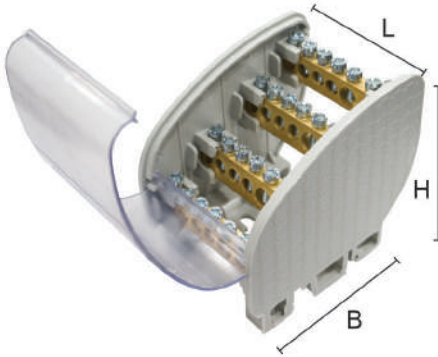

10 KABLO KESİTLİ 4 KUTUPLU DAĞITIM ÜNİTESİ (6,5x9 mm Kesit)

YÜKSEK MODEL
80 Amp.

KOD	AÇIKLAMA	L	B	H	KOLİ AD.	FİYAT \$
80-1507	2+5	60	80	75	10	10,600 \$
80-1510	2+8	83	80	75	8	11,120 \$
80-1512	2+10	92	80	75	6	12,630 \$
80-1515	2+13	114	80	75	5	15,660 \$
80-1520	2+18	154	80	75	4	16,675 \$
80-1522	2+20	160	80	75	4	21,725 \$
80-1525	2+23	198	80	75	4	24,420 \$



BAKIR NÖTR TOPRAK EŞ POTANSİYEL BARALAR 250 AMPER 5X20 (PLASTİK AYAKLI)

KOD	CİNSİ	L	B	H	KOLİ AD.	FİYAT \$
3708	1 Giriş 7 Çıkış	220	40	39	100	14,150 \$
3711	1 Giriş 10 Çıkış	270	40	39	75	17,700 \$
3715	1 Giriş 14 Çıkış	345	40	39	50	22,320 \$

1 KUTUP DAĞITICI ÜNİTELER RAY GEÇMELİ KAPAKSIZ 6,5x9 mm 80 Amp

KOD	AÇIKLAMA	L	KOLİ AD.	FİYAT \$
1706	2+4 6 Delikli Ünite	60	80	2,100 \$
1707	2+5 7 Delikli Ünite	66	70	2,400 \$
1710	2+8 10 Delikli Ünite	82	65	2,500 \$
1712	2+10 12 Delikli Ünite	100	55	2,900 \$
1715	2+13 15 Delikli Ünite	115	45	3,500 \$
1720	2+18 20 Delikli Ünite	142	30	4,800 \$
1725	2+23 25 Delikli Ünite	185	25	6,000 \$
1730	2+28 30 Delikli Ünite	215	25	7,200 \$

1 KUTUP DAĞITICI ÜNİTELER RAY GEÇMELİ KAPAKSIZ 7x12 mm 125 Amp

KOD	AÇIKLAMA	L	KOLİ AD.	FİYAT \$
1907	2+5 7 Delikli Ünite	75	65	2,480 \$
1910	2+8 10 Delikli Ünite	100	55	2,950 \$
1912	2+10 12 Delikli Ünite	115	45	3,160 \$
1915	2+13 15 Delikli Ünite	135	30	4,200 \$
1920	2+18 20 Delikli Ünite	170	30	5,800 \$
1922	2+20 22 Delikli Ünite	185	25	6,600 \$
1925	2+23 25 Delikli Ünite	207	25	7,000 \$
1930	2+28 30 Delikli Ünite	245	20	8,130 \$

1 KUTUP DAĞITICI ÜNİTELER RAY GEÇMELİ KAPAKLI 6,5x9 mm 80 Amp

KOD	AÇIKLAMA	L	KOLİ AD.	FİYAT \$
1806	2+4 6 Delikli Ünite	60	70	2,360 \$
1807	2+5 7 Delikli Ünite	66	60	2,480 \$
1810	2+8 10 Delikli Ünite	82	55	3,250 \$
1812	2+10 12 Delikli Ünite	100	45	3,400 \$
1815	2+13 15 Delikli Ünite	115	35	4,850 \$
1820	2+18 20 Delikli Ünite	142	25	5,850 \$
1825	2+23 25 Delikli Ünite	185	20	7,000 \$
1830	2+28 30 Delikli Ünite	215	20	8,250 \$

1 KUTUP DAĞITICI ÜNİTELER RAY GEÇMELİ KAPAKLI 7x12 mm 125 Amp

KOD	AÇIKLAMA	L	KOLİ AD.	FİYAT \$
2007	2+5 7 Delikli Ünite	75	60	3,000 \$
2010	2+8 10 Delikli Ünite	100	40	3,500 \$
2012	2+10 12 Delikli Ünite	115	40	4,130 \$
2015	2+13 15 Delikli Ünite	135	30	4,640 \$
2020	2+18 20 Delikli Ünite	170	25	6,850 \$
2022	2+20 22 Delikli Ünite	185	20	7,160 \$
2025	2+23 25 Delikli Ünite	207	15	8,120 \$
2030	2+28 30 Delikli Ünite	245	15	9,260 \$

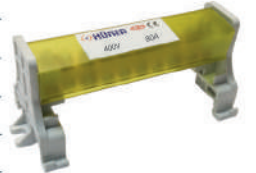
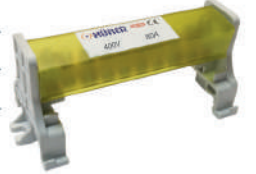

4 KUTUP 7x12 KESİT 125 AMP DAĞITICI ÜNİTELER (AYAK GEÇMELİ)

ALÇAK MODEL

KOD	CİNSİ	L	B	H	KOLİ AD.	FİYAT \$
4307	2+5	105	144	55	12	15,660 \$
4310	2+8	145	144	55	8	17,680 \$
4312	2+10	165	144	55	8	20,720 \$
4315	2+13	200	144	55	6	24,760 \$
4320	2+18	255	144	55	4	31,830 \$
4322	2+20	275	144	55	4	33,350 \$

4 KUTUP 10x15 KESİT 160 AMP DAĞITICI ÜNİTELER (AYAK GEÇMELİ)

ALÇAK MODEL

KOD	CİNSİ	L	B	H	KOLİ AD.	FİYAT \$
3207	2+5	105	144	55	12	22,480 \$
3210	2+8	145	144	55	8	32,840 \$
3212	2+10	165	144	55	8	38,900 \$
3215	2+13	200	144	55	6	48,500 \$
3220	2+18	255	144	55	4	63,150 \$
3222	2+20	275	144	55	4	64,965 \$

4 KUTUP 200 AMPER 3x15 BAKIR BARALAR

KOD	CİNSİ	L	B	H	KOLİ AD.	FİYAT \$
3508	1 Giriş 7 Çıkış	220	150	95	6	42,950 \$
3511	1 Giriş 10 Çıkış	280	150	95	4	48,000 \$
3515	1 Giriş 14 Çıkış	354	150	95	4	55,580 \$

4 KUTUP 250 AMPER 5x20 BAKIR BARALAR

KOD	CİNSİ	L	B	H	KOLİ AD.	FİYAT \$
3408	1 Giriş 7 Çıkış	220	150	95	6	48,420 \$
3411	1 Giriş 10 Çıkış	280	150	95	4	51,360 \$
3415	1 Giriş 14 Çıkış	354	150	95	4	61,640 \$



