

JAMESON®

Yeni Nesil Teknoloji...

2024/OCAK
www.kivilcimelektrik.com.tr

Whatsapp Sipariř Hattı: **0531 727 74 64** 

Jameson®

GENEL BAKIŞ

1992 yılında Jameson Elektronik olarak kurulan firmamız siz değerli müşterilerimize gösterdiği değer ve kusursuz hizmet daima yenilikçi ve teknolojiyi takip eden hizmet anlayışındadır. Kuruluş tarihimizden bugüne kadar hedeflerimiz kalite, güven, dostluk, müşteri memnuniyetini ön planda tutmaktır. Misyonumuz mükemmeliyetçi kalite anlayışımızla sizi her zaman daha iyiye ve daha pratiğe yönlendirmektedir. Firmamız kurulduğu günden itibaren müşterilerimizin bize olan güveni ve hizmetlerimizin kusursuzluğu ile elektrik-elektronik sektöründe kendine iyi bir yer edinmiştir.

2020 yılından itibaren Jameson markası ile Kıvılcım Elektrik olarak elektrik malzemelerini de bünyesine katan firmamız binlerce çeşidi ile kalite ve yenilikçi anlayışıyla elektrik sektöründe de hizmet etmeye başlamıştır.

İÇİNDEKİLER

KABLO BAĞLARI VE AKSESUARLARI

Standart Beyaz Kablo Bağları	4
Standart Siyah Kablo Bağları	5
Standart Renkli Kablo Bağları	6
Ultraviyole Kablo Bağları	7
Boncuk Kablo Bağları	7
Paslanmaz Çelik Kablo Bağları	8
Paslanmaz Çelik Etiket	8
PVC Kaplı Paslanmaz Çelik Kablo Bağları	9
Etiketli Kablo Bağları	10
Açılabilir Kablo Bağları	10
Distanslı Kablo Bağları	10
Kartuş Yükseltici	11
Beton Kroşe	11
Vidalı Kroşe	11
Yapışkanlı Kroşeler	12
Kapama Parçası	12
Kablo Kelepçesi	12
Kablo Bağı Etiket Taşıyıcı	13
Yapışkanlı Pano Etiket Taşıyıcı	13
Kablo İşaretleme Sistemleri	13
Kablo Toplama Spiralleri	14

KABLO YÜKSÜKLERİ VE KABLO UÇLARI

İzoleli Kablo Yüksükleri Fransız Normu	16
İzoleli Kablo Yüksükleri Alman Normu	17
Çift Girişli Kablo Yüksükleri Fransız Normu	18
Çift Girişli Kablo Yüksükleri Alman Normu	19
İzolesiz Kablo Yüksükleri	20

KABLO UÇLARI

Yuvarlak Tip İzoleli Kablo Uçları	21
Çatal Tip İzoleli Kablo Uçları	22
Ek Mufları İzoleli Kablo Uçları	23
Erkek Terminaller İzoleli Kablo Uçları	23
Dişi Terminaller İzoleli Kablo Uçları	23
Dişi Faston Tip İzoleli Kablo Uçları	24
Tam İzoleli Dişi Faston Tip Kablo Uçları	24
Tam İzoleli Polyamid Dişi Faston Tip Kablo Uçları	24

İğne Tip İzoleli Kablo Uçları	25
Erkek/Dişi Geri Dönümlü Terminaller	25
Tam İzoleli Polyamid Bayrak Tip Terminaller	25
Erkek Faston Tip Kablo Uçları	26
Vidalı Buat Klemensleri	26
Hızlı Kablo Ekleme Parçası	26
İzolesiz Kablo Ucu ve Konnektörleri	27

BAĞLANTI ELEMANLARI

SKP-E Ekonomik Tip Kablo Pabucu	29
SKP-S Standart Tip Kablo Pabucu	30
Bimetalik Sıkmalı Kablo Pabuçları	31
Ek Mufları	32
U Klemens	33
Monofaze Müşterek W Otomat Barları	34
Trifaze Müşterek W Otomat Barları	34
Montaj Rayları	35
Nötr Topraklama Baralar	35
Raya Montajlı Priz	35
Eriyen Bantlar	36
Pvc İzole Bant	36
Jks Serisi Kapı Siviçleri	36
2 Kutuplu Dağıtıcı Üniteler	37
4 Kutuplu Dağıtıcı Üniteler	38
Tek Kutuplu Dağıtıcı Üniteler	39-40

ÇOK AMAÇLI KLEMENSLER

Geçmeli Buat Klemens	42
Çok Amaçlı Klemens	42
Dağıtıcılı Buat Klemens	43

MAKARON ÇEŞİTLERİ ve KABLO TOPLAMA ÇORAPLARI

Isı İle Daralan Siyah Makaronlar	45
Isı İle Daralan Renkli Makaronlar	46-47
Isı İle Daralan Makaronlar	48
İçi Yapışkanlı Boru Tipi Makaronlar	49
H Class Cam Elyaf Silikon İzoleli Makaronlar	50
PVC İzoleli Cam Elyaf Makaronlar	51
Kablo Toplama Çorabı	52

MEKANİK VE HİDROLİK EL ALETLERİ

Yüksük Sıkma Penseleri/Mekanik El Aletleri	54
Kablo Sıyırıcıları/Mekanik El Aletleri	56
Kablo Kesme Makasları	58-60
Kablo Pabucu Mekanik ve Hidrolik Sıkma Penseleri	59

BUTON SERİSİ VE AKSESUARLARI

Yaylı Butonlar	62
İkiz Butonlar	62

Ø 22mm Buton Serisi

Kalıcı Mandal Butonlar	63
Kayıcı Kandal Butonlar	63
Anahtarlı Kalıcı & Kayıcı Butonlar	63
Joystick Vinç Butonları	64
Işıklı Kalıcı Mandal Butonlar	65
40 mm Kalıcı Mantar Butonlar	66
40 mm Kalıcı Anahtarlı Mantar Buton	66
40 mm Kayıcı Mantar Butonlar	66
40 mm Kalıcı Mantar Butonlar	66
Buton Aksesuarları	67
Boş Buton Kutuları	68
Kutulu Acil Stop Buton	68
Ø 22mm Voltmetre	69
Ø 22mm Ampermetre	69
Ø 22mm Ledli Sinyaller	70
Ø 16mm Ledli Sinyaller	70
BA9S Led Ampuller	71
Metal Ledli Sinyaller	72

Buzzerlar

Ø 22mm Ledli Buzzer	73
Ø 22mm Sesli Buzzer	73
Motorlu Sirenler	73
Elektronik Sirenler	74
Ø 22mm Potansiyometre	74
Pano İçi Termostatlar	74

Vinç Kumanda Butonları

Plastik Vinç Kumandalar (IP67)	75
Acil Stoplu Plastik Vinç Kumandalar (IP67)	75
Ayak Pedalları	76

SWITCH FAN VE FİLTRE ÇEŞİTLERİ

JLS Serisi Limit Switch	78-81
JMZ Serisi Mikro Switch	82-84
JMS Serisi Mikro Switch	85
Fanlar	86
Fan Filtreleri	86
Fan Koruma Telleri	86

Dikkat !

Bu fiyat listesindeki tipografik baskı hatalarından firmamız sorumlu değildir. Firmamız fiyat listesinde yayınlanmış olduğu teknik özellikleri değiştirme, dövizve hammadde artışlarından dolayı meydana gelebilecek fiyat artışlarını hiçbir uyarıda bulunmaksızın fiyat listesine yansıtma hakkına sahiptir.



JAMESON®

KABLO BAĞLARI VE AKSESUARLAR

www.kivilcimelektrik.com.tr

STANDART BEYAZ KABLO BAĞLARI

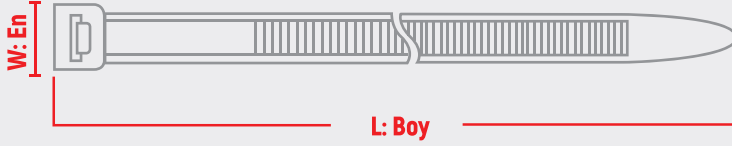

MALZEME: Saf Naylon 6.6 Standart UL
ÇALIŞMA SICAKLIĞI: -40 °C - +85 °C



Sipariş Kodu	Ürün Kodu	Boyutlar		Renk	Maksimum Sıkma Çapı (mm)	Açıklama Mukavemeti (kg)	AmbalajAdet		Birim Fiyat TL / Adet
		Uzunluk (mm)	En (mm)				Paket	Koli	
3001	JKB-2510B	100		Beyaz	20		100	65.000	0,220
3002	JKB-2515B	150	2.5	Beyaz	36	8	100	50.000	0,340
3003	JKB-2520B	200		Beyaz	52		100	35.000	0,480
3004	JKB 3615B	150		Beyaz	36		100	23.000	0,570
3005	JKB 3620B	200		Beyaz	52		100	18.000	0,750
3006	JKB-3625B	250	3.6	Beyaz	68	18	100	18.000	0,910
3007	JKB-3630B	300		Beyaz	84		100	15.000	1,150
3008	JKB-3637B	370		Beyaz	106		100	12.000	1,450
3009	JKB-4820B	200		Beyaz	50		100	13.000	1,060
3010	JKB-4825B	250		Beyaz	65		100	12.000	1,300
3011	JKB-4830B	300	4.8	Beyaz	81	22	100	11.000	1,590
3012	JKB-4837B	370		Beyaz	104		100	6.000	1,830
3013	JKB-4843B	430		Beyaz	123		100	7.500	2,450
3015	JKB-7630B	300		Beyaz	76		100	5.000	3,250
3016	JKB-7637B	370		Beyaz	102		100	4.000	3,550
3017	JKB-7645B	430	7.6	Beyaz	110	55	100	3.000	4,150
3018	JKB-7655B	530		Beyaz	140		100	2.000	5,400
3020	JKB-7675B	750		Beyaz	226		100	1,200	8,300
3022	JKB-9710B	710		Beyaz	190		100	1,200	8,900
3023	JKB-9780B	780		Beyaz	228		100	1,200	11,000
3024	JKB-9920B	920	9	Beyaz	280	80	100	1,200	12,500
3025	JKB-91020B	1020		Beyaz	295		100	1.000	13,000
3026	JKB-91220B	1220		Beyaz	375		100	1.000	16,200

STANDART SİYAH KABLO BAĞLARI

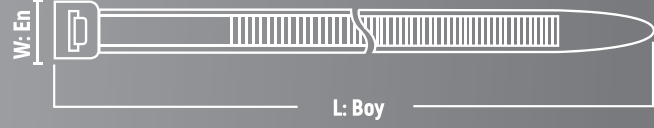

MALZEME: Saf Naylon 6.6 Standart UL
ÇALIŞMA SICAKLIĞI: -40 °C - +85 °C

Sipariş Kodu	Ürün Kodu	Boyutlar		Renk	Maksimum Sıkma Çapı (mm)	Açıklama Mukavemeti (kg)	Ambalaj/Adet		Birim Fiyat TL / Adet
		Uzunluk (mm)	En (mm)				Paket	Koli	
3027	JKB-2510S	100		Siyah	20		100	65.000	0,220
3028	JKB-2515S	150	2.5	Siyah	36	8	100	50.000	0,340
3029	JKB-2520S	200		Siyah	52		100	35.000	0,480
3030	JKB-3615S	150		Siyah	36		100	23.000	0,570
3031	JKB-3620S	200		Siyah	52		100	18.000	0,750
3032	JKB-3625S	250	3.6	Siyah	68	18	100	18.000	0,910
3033	JKB-3630S	300		Siyah	84		100	15.000	1,150
3034	JKB-3637S	370		Siyah	106		100	12.000	1,450
3035	JKB-4820S	200		Siyah	50		100	13.000	1,060
3036	JKB-4825S	250		Siyah	65		100	12.000	1,300
3037	JKB-4830S	300	4.8	Siyah	81	22	100	11.000	1,590
3038	JKB-4837S	370		Siyah	104		100	9.000	1,830
3039	JKB-4843S	430		Siyah	123		100	6.500	2,450
3041	JKB-7630S	300		Siyah	76		100	5.000	3,250
3042	JKB-7637S	370		Siyah	102		100	4.000	3,550
3043	JKB-7645S	430	7.6	Siyah	110	55	100	3.000	4,150
3044	JKB-7655S	530		Siyah	140		100	2.000	5,400
3046	JKB-7675S	750		Siyah	226		100	1,200	8,300
3047	JKB-9710S	710		Siyah	190		100	1,200	8,900
3048	JKB-9780S	780		Siyah	228		100	1,200	11,000
3049	JKB-9920S	920	9	Siyah	280	80	100	1,200	12,500
3050	JKB-91020S	1020		Siyah	295		100	1.000	13,000
3051	JKB-91220S	1220		Siyah	375		100	1.000	16,200

STANDART RENKLİ KABLO BAĞLARI

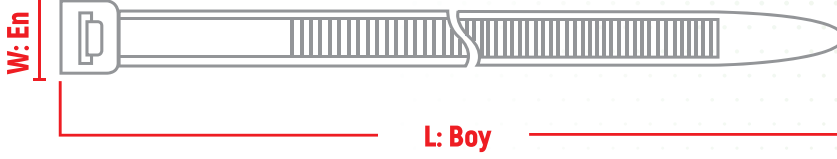

MALZEME: Saf Naylon 6.6 Standart UL
ÇALIŞMA SICAKLIĞI: -40 °C - +85 °C

Sipariş Kodu	Ürün Kodu	Boyutlar		Renk	Maksimum Sıkma Çapı (mm)	Açıklama Mukavemeti (kg)	AmbalajAdet		Birim Fiyat TL / Adet
		Uzunluk (mm)	En (mm)				Paket	Koli	
3101	JKB-2510K	100	2.5	Kırmızı	20	8	100	65,000	0,240
3102	JKB-3615K	150			36		100	23,000	0,580
3103	JKB-3620K	200	3.6	Kırmızı	52	18	100	18,000	0,800
3104	JKB-3625K	250			68		100	18,000	0,950
3105	JKB-3630K	300			84		100	15,000	1,200
3106	JKB-4820K	200			50		100	13,000	1,100
3107	JKB-4825K	250	4.8	Kırmızı	65	22	100	12,000	1,370
3108	JKB-4830K	300			81		100	11,000	1,650
3109	JKB-4837K	370			101		100	9,000	1,950
3110	JKB-2510M	100	2.5		20	8	100	65,000	0,240
3111	JKB-3615M	150			36		100	23,000	0,580
3112	JKB-3620M	200	3.6		52	18	100	18,000	0,800
3113	JKB-3625M	250			68		100	18,000	0,950
3114	JKB-3630M	300		Mavi	84		100	15,000	1,200
3115	JKB-4820M	200			50		100	13,000	1,100
3116	JKB-4825M	250	4.8		65	22	100	12,000	1,370
3117	JKB-4830M	300			81		100	11,000	1,650
3118	JKB-4837M	370			101		100	9,000	1,950
3119	JKB-2510SR	100	2.5		20	8	100	65,000	0,240
3120	JKB-3615SR	150			36		100	23,000	0,580
3121	JKB-3620SR	200	3.6		52	18	100	18,000	0,800
3122	JKB-3625SR	250			68		100	18,000	0,950
3123	JKB-3630SR	300		Sarı	84		100	15,000	1,200
3124	JKB-4820SR	200			50		100	13,000	1,100
3125	JKB-4825SR	250	4.8		65	22	100	12,000	1,370
3126	JKB-4830SR	300			81		100	11,000	1,650
3127	JKB-4837SR	370			104		100	9,000	1,950
3128	JKB-2510Y	100	2.5		20	8	100	65,000	0,240
3129	JKB-3615Y	150			36		100	23,000	0,580
3130	JKB-3620Y	200	3.6		52	18	100	18,000	0,800
3131	JKB-3625Y	250			68		100	18,000	0,950
3132	JKB-3630Y	300		Yeşil	84		100	15,000	1,200
3133	JKB-4820	200			50		100	13,000	1,100
3134	JKB-4825Y	250	4.8		65	22	100	12,000	1,370
3135	JKB-4830Y	300			81		100	11,000	1,650
3136	JKB-4837Y	370			101		100	9,000	1,950

ULTRAVIOLE KABLO BAĞLARI

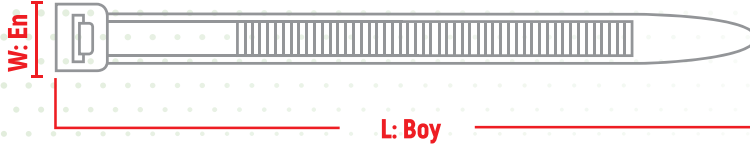

MALZEME: Saf Naylon 6.6 Standart UL
ÇALIŞMA SICAKLIĞI: -40 °C - +85 °C



Sipariş Kodu	Ürün Kodu	Boyutlar		Renk	Maksimum Sıkma Çapı (mm)	Açıklama Mukavemeti (kg)	AmbalajAdet		Birim Fiyat TL / Adet
		Uzunluk (mm)	En (mm)				Paket	Koli	
3201	JKB-2510UV	100		Siyah	20		1.000	65,000	0,250
3202	JKB-2515UV	150	2.5	Siyah	36	8	1.000	50,000	0,370
3203	JKB-2520UV	200		Siyah	52		1.00	35,000	0,540
3204	JKB-3615UV	150		Siyah	36		100	23,000	0,600
3205	JKB-3620UV	200		Siyah	52		100	18,000	0,830
3206	JKB-3625UV	250	3.6	Siyah	68	18	100	18,000	1,000
3207	JKB-3630UV	300		Siyah	84		100	15,000	1,230
3208	JKB-3637UV	370		Siyah	50		100	12,000	1,735
3209	JKB-4820UV	200		Siyah	65		100	13,000	1,120
3210	JKB-4825UV	250		Siyah	81		100	12,000	1,400
3211	JKB-4830UV	300	4.8	Siyah	104	22	100	11,000	1,750
3212	JKB-4837UV	370		Siyah	123		100	9,000	2,000
3213	JKB-4843UV	430		Siyah	76		100	6,000	2,700
3215	JKB-7630UV	300		Siyah	76		100	5,000	3,500
3216	JKB-7637UV	370	7.6	Siyah	102	55	100	4,000	3,800
3217	JKB-7645UV	430		Siyah	110		100	3,000	4,400
3218	JKB-7653UV	530		Siyah	140		100	2,000	5,800
3219	JKB-9710UV	710	9	Siyah	190	80	100	2,000	10,750
3220	JKB-9780UV	780		Siyah	228		100	2,000	12,000

BONCUK KABLO BAĞLARI

Sipariş Kodu	Ürün Kodu	Boyutlar		Maksimum Bağlama Çapı (mm)	Minimum Açma Kuvveti (kg)	AmbalajAdet		Birim Fiyat TL / Adet
		Uzunluk (mm)	En (mm)			Paket	Koli	
3228	JBKB-2510	105	2	25	5	1.000	50.000	0,525
3229	JBKB-3517	165	3.5	45	7	500	25.000	1,395

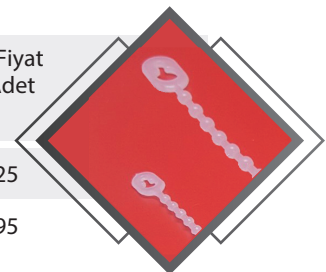

PASLANMAZ ÇELİK KABLO BAĞLARI

Sipariş Kodu	Ürün Kodu	Boyutlar		Renk	Maksimum Sıkma Çapı (mm)	Açıklama Mukavemeti (kg)	AmbalajAdet		Birim Fiyat TL / Adet
		Uzunluk (mm)	En (mm)				Paket	Koli	
3301	JMT-4615	150	4.6	Metal	44	55	100	8.000	3,500
3302	JMT-4620	200		Metal	51		100	6.000	3,900
3303	JMT-4625	260		Metal	69		100	5.000	4,400
3304	JMT-4630	300		Metal	76		100	5.000	4,700
3305	JMT-4635	370		Metal	102		100	4.000	5,200
3306	JMT-4650	520		Metal	152		100	3.000	6,500
3307	JMT-4670	680		Metal	203		100	2.000	8,000
3308	JMT-4685	840		Metal	254		100	1.000	9,500
3309	JMT-7920	200	7.9	Metal	50	120	100	5.000	6,100
3310	JMT-7930	300		Metal	75		100	4.000	7,000
3311	JMT-7935	370		Metal	102		100	3.000	8,200
3312	JMT-7950	520		Metal	152		100	2.000	10,300
3313	JMT-7970	680		Metal	203		100	2.000	12,000
3314	JMT-7985	840		Metal	224		100	1.000	15,000

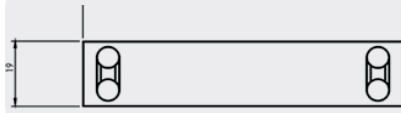

Malzeme : 304 Paslanmaz Çelik
 Su emilimi : Yok
 Alev yürmeme : UL94V-2



PASLANMAZ ÇELİK ETİKET

Sipariş Kodu	Ürün Kodu	Açıklama	Renk	Boy ve Genişlik (mm)	AmbalajAdet	Birim Fiyat TL / Adet
1351	MTL PE	Paslanmaz Çelik Etiket	Metal	19 x 90	100	6,550

Paslanmaz Çelik Kablo Bağları

- Kendiliğinden kilitlenebilir kafa tasarımı, kurulumu hızlandırır ve kablo bağı gövdesi boyunca herhangi bir boyda kilitlemeyi sağlar.
- Güçlü ve dayanıklı kablo bağlama yöntemini temin eder.
- Çok çeşitli iç mekân ve dış mekân uygulama alanlarında kullanılabilir.
- Pürüzsüz yüzeyi ve yuvarlatılmış uçları ile kabloların korunmasını ve çalışan kişinin güvenliğini garanti eder.
- Genel amaçlı uygulamalar için : 304 paslanmaz çelik

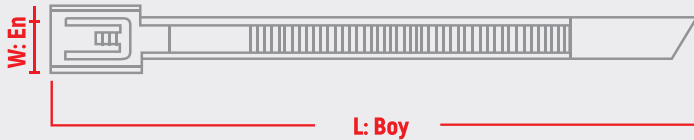

MALZEME: 304 Paslanmaz Çelik
SU EMİLİMİ: Yok
ALEV YÜRME: UL94V-2



PVC KAPLI PASLANMAZ ÇELİK KABLO BAĞLARI

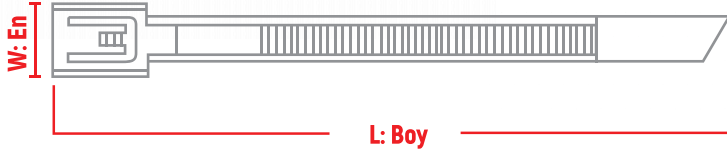

MALZEME: 304 Paslanmaz Çelik

SU EMİLİMİ: Yok

ALEV YÜRME: UL94V-2

Sipariş Kodu	Ürün Kodu			Renk	Maksimum Sıkma Çapı (mm)	Açıklama Mukavemeti (kg)			Birim Fiyat TL / Adet
		Uzunluk (mm)	En (mm)				Paket	Koli	
3401	JMT-4615P	100	4.6	Metal	44	55	100	8.000	5,200
3402	JMT-4620P	200		Metal	51		100	6.000	5,800
3403	JMT-4625P	260		Metal	69		100	5.000	6,400
3404	JMT-4630P	300		Metal	76		100	5.000	7,000
3405	JMT-4635P	370		Metal	102		100	4.000	8,500
3406	JMT-4650P	520		Metal	152		100	3.000	11,000
3407	JMT-4670P	680		Metal	203		100	2.000	13,000
3408	JMT-4685P	840		Metal	254		100	1.000	17,000
3409	JMT-7920P	200	7.9	Metal	50	120	100	5.000	7,700
3410	JMT-7930P	300		Metal	75		100	4.000	10,000
3411	JMT-7935P	370		Metal	102		100	3.000	11,000
1312	JMT-7950P	520		Metal	152		100	2.000	15,000
3413	JMT-7970P	680		Metal	203		100	2.000	19,000
3414	JMT-7985P	840		Metal	224		100	1.000	23,000

PVC Kaplı Paslanmaz Çelik Kablo Bağları

- Kendiliğinden kilitlenebilir kafa tasarımı, kurulumu hızlandırır ve kablo bağı gövdesi boyunca herhangi bir boyda kilitlemeyi sağlar.
- Güçlü ve dayanıklı kablo bağlama yöntemini temin eder.
- Çok çeşitli iç mekân ve dış mekân uygulama alanlarında kullanılabilir.
- Pürüzsüz yüzeyi ve yuvarlatılmış uçları ile kablunun korunmasını ve çalışan kişinin güvenliğini garanti eder.
- Şebeke kablolarında en üst düzey desteği sağlar.
- Genel amaçlı uygulamalar için : 304 paslanmaz çelik

ETİKETLİ KABLO BAĞLARI

JEKB-2510Y
L: Boy

JEKB-4819D
L: Boy

MALZEME:
Saf Naylon 6.6 Standart UL

ÇALIŞMA SICAKLIĞI:
-40 °C - +85 °C

Sipariş Kodu	Ürün Kodu	Boyutlar		Renk	Maksimum Sıkma Çapı (mm)	Açılma Mukavemeti (mm)	Ambalaj Adet		Birim Fiyat TL / Adet
		Uzunluk (mm)	En (mm)				Paket	Koli	
3501	JEKB-2510Y	100	2.5	Beyaz	20	8	100	30.000	0,710
3502	JEKB-4819D	190	4.8	Beyaz	48	22	100	12.000	1,700

AÇILABİLİR KABLO BAĞLARI

JAKB-7620
L: Boy

JAKB-7637
L: Boy

MALZEME:
Saf Naylon 6.6 Standart UL

ÇALIŞMA SICAKLIĞI:
-40 °C - +85 °C

Sipariş Kodu	Ürün Kodu	Boyutlar		Renk	Maksimum Sıkma Çapı (mm)	Açılma Mukavemeti (mm)	Ambalaj Adet		Birim Fiyat TL / Adet
		Uzunluk (mm)	En (mm)				Paket	Koli	
3503	JAKB-7620	200	7.6	Beyaz	50	36	100	5.000	2,400
3504	JAKB-7637	370	7.6	Beyaz	100	36	100	3.000	4,000

DİSTANSLI KABLO BAĞI

JDKB-2510
L: Boy

JDKB-3615
L: Boy

JDKB-4820
L: Boy

MALZEME:
Saf Naylon 6.6 Standart UL

ÇALIŞMA SICAKLIĞI:
-40 °C - +85 °C

Sipariş Kodu	Ürün Kodu	Boyutlar		Renk	Maksimum Sıkma Çapı (mm)	Açılma Mukavemeti (mm)	Ambalaj Adet		Birim Fiyat TL / Adet
		Uzunluk (mm)	En (mm)				Paket	Koli	
3505	JDKB-2510	100	2.5	Beyaz	20	8	100	50.000	0,700
3506	JDKB-3615	150	3.6	Beyaz	35	18	100	30.000	1,000
3507	JDKB-4820	200	4.8	Beyaz	50	22	100	12.000	2,100

KARTUŞ YÜKSELTİCİ

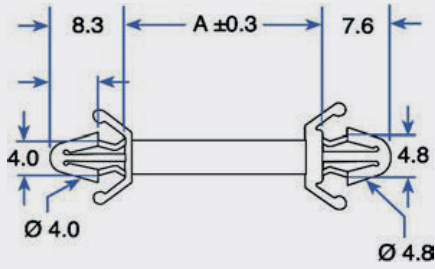

MALZEME:

Saf Naylon 6.6 Standart UL

ÇALIŞMA SICAKLIĞI:

-40 °C «» +85 °C



Sipariş Kodu	Ürün Kodu	Boyutlar		Renk	Ambalaj Adet		Birim Fiyat TL / Adet
		A			Paket	Koli	
3521	JBS-9A	9.2		Beyaz	100	40.000	0,830
3522	JBS-13A	12.6		Beyaz	100	35.000	0,860
3523	JBS-16A	15.8		Beyaz	100	25.000	1,050

BETON KROŞE

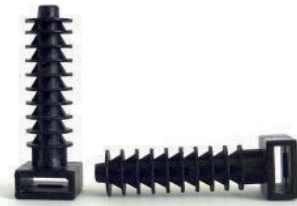
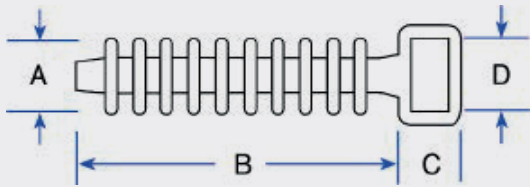

Sipariş Kodu	Ürün Kodu	Boyutlar				Maksimum Sıkma Çapı (mm)	Renk	Ambalaj Adet		Birim Fiyat TL / Adet
		A	B	C	D			Paket	Koli	
3524	JH-2	9.5	36.0	6.0	9.5	ø 9.5	Siyah	100	5.000	1,300

VİDALI KROŞE

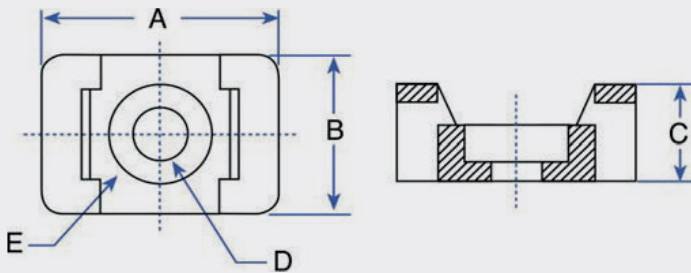

Sipariş Kodu	Ürün Kodu	Boyutlar					Maksimum Sıkma Çapı (mm)	Renk	Ambalaj Adet		Birim Fiyat TL / Adet
		A	B	C	D	E			Paket	Koli	
3525	JKV - 1	14.9	9.5	6.9	4.5	7.8	4.8	Beyaz	100	5.000	0,740
3526	JKV - 2	22.2	15.9	9.7	6.4	12.6	7.6	Beyaz	100	5.000	1,070

YAPIŞKANLI KROŞELER



MALZEME:

Saf Naylon 6.6 Standart UL

ÇALIŞMA SICAKLIĞI:

-40 °C «» +85 °C

Sipariş Kodu	Ürün Kodu	Boyutlar					Renk	Ambalaj Adet		Birim Fiyat TL / Adet
		A	B	C	D	H		Paket	Koli	
3513	JYK-1919B	19	19	3.6	ø 3.2	4.0	Beyaz	100	20.000	1,000
3514	JYK-2828B	28	28	4.8	ø 3.2	4.5	Beyaz	100	5.000	1,780
3515	JYK-1919S	19	19	3.6	ø 3.2	4.0	Siyah	100	20.000	1,000
3516	JYK-2828S	28	28	4.8	ø 3.2	4.5	Siyah	100	5.000	1,780

KAPAMA PARÇASI

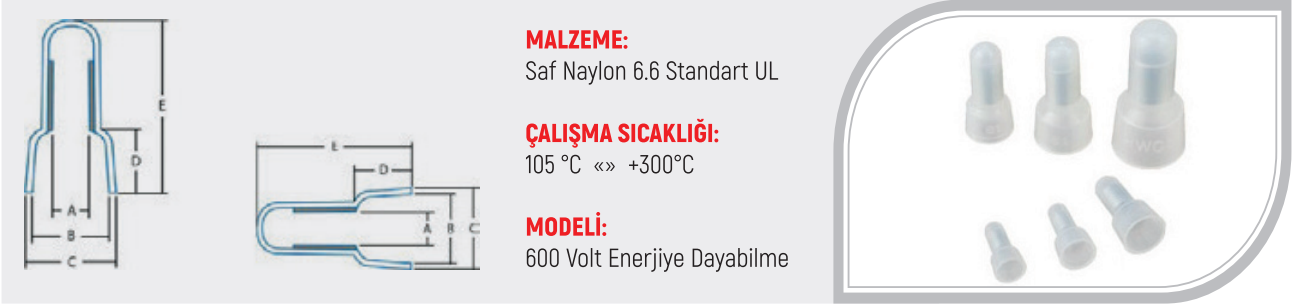

MALZEME:

Saf Naylon 6.6 Standart UL

ÇALIŞMA SICAKLIĞI:

105 °C «» +300 °C

MODELİ:

600 Volt Enerjiye Dayabilme

Sipariş Kodu	Ürün Kodu	Boyutlar					Renk	Ambalaj Adet		Birim Fiyat TL / Adet
		A	B	C	D	H		Paket	Koli	
3517	JW-C4	19	19	3.6	ø 3.2	4.0	Beyaz	100	20.000	0,550
3518	JW-C5	28	28	4.8	ø 3.2	4.5	Beyaz	100	9.000	0,970

KABLO KELEPÇESİ

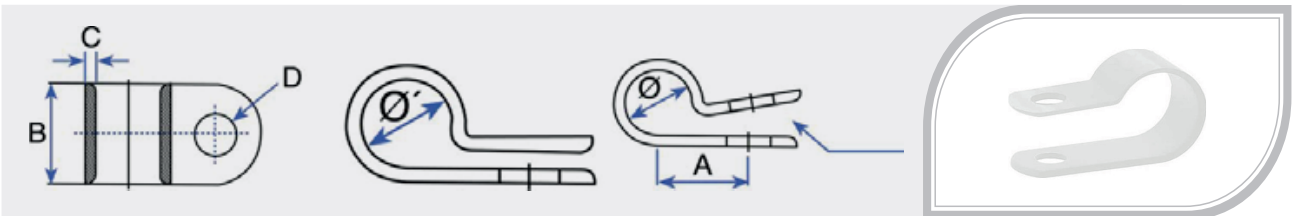

Sipariş Kodu	Ürün Kodu	Boyutlar						Renk	Ambalaj Adet		Birim Fiyat TL / Adet
		Q	Q1	A	B	C	D		Paket	Koli	
3519	JKK-14	7.4	6.6	10.3	9.1	1.27	M5	Beyaz	100	30.000	0,700
3520	JKK-38	10.9	9.7	11.9	9.2	1.27	M5	Beyaz	100	20.000	0,850

KABLO BAĞI ETİKET TAŞIYICI

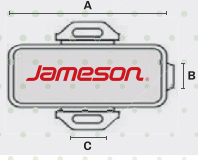

MALZEME: Polipropilen
ÇALIŞMA SICAKLIĞI: 0°C «» +90 °C

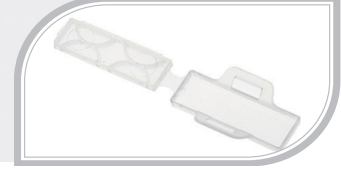

Sipariş Kodu	Ürün Kodu	Boyutlar			Etiket Eni (mm)	Etiket Boyu (mm)	Renk	Ambalaj Adet		Birim Fiyat TL / Adet
		A	B	C				Paket	Koli	
3527	JET-1	35	10	8	32	7	Beyaz	100	12.500	1,750
3528	JET-2	45	20	8	42	17	Beyaz	100	6.000	3,050

YAPIŞKANLI PANO ETİKET TAŞIYICI



MALZEME: ABS Altılık, PS Kapak + Çift Taraflı Bant
ÇALIŞMA SICAKLIĞI: -40 °C «» +60 °C



Sipariş Kodu	Ürün Kodu	Boyutlar		Etiket Eni (mm)	Etiket Boyu (mm)	Renk	Ambalaj Adet		Birim Fiyat TL / Adet
		A	B				Paket	Koli	
3529	JPET-1	30	17	27.5	14.4	Siyah	100	12.000	2,050
3530	JPET-2	50	17	49	15	Siyah	100	6.000	2,700
3531	JPET-3	75	17	72	15	Siyah	100	5.000	3,700

KABLO İŞARETLEME SİSTEMLERİ

BASKI HARFLERİ	BASKI NUMARASI	EC - 0		EC - 1		EC - 2	
		Sipariş Kodu	Fiyat	Sipariş Kodu	Fiyat	Sipariş Kodu	Fiyat
A	0	3601		3623		3645	
B	1	3602		3624		3646	
C	2	3603		3625		3647	
D	3	3604		3626		3648	
E	4	3605		3627		3649	
F	5	3606		3628		3650	
G	6	3607		3629		3651	
H	7	3608		3630		3652	
I	8	3609		3631		3653	
K	9	3610		3632		3654	
L	9	3611		3633		3655	
M	9	3612	95 TL.	3634	95 TL.	3656	95 TL.
N	9	3613		3635		3657	
O	9	3614		3636		3658	
P	9	3615		3637		3659	
R	9	3616		3638		3660	
S	9	3617		3639		3661	
T	9	3618		3640		3662	
U	9	3619		3641		3663	
V	9	3620		3642		3664	
Y	9	3621		3643		3665	
Z	9	3622		3644		3666	



KABLO TOPLAMA SİRALLERİ



Sipariş Kodu	Ürün Kodu	O.D.	T	W	Kablo Kesit (mm ²)	Renk	Paket Miktarı (Mt)	Koli Miktarı (Mt)	Birim Fiyat TL/Metre
3701	JHS-6 (No1)	6	0.60	7.4	2.5 - 15	Beyaz	10	1.000	6,98
3702	JHS-8 (No2)	8	0.75	12	6 - 30	Beyaz	10	800	7,95
3703	JHS-10 (No3)	10	0.80	12.3	7.5 - 30	Beyaz	10	500	9,77
3704	JHS-12 (No4)	12	0.85	15	9 - 32	Beyaz	10	400	14,60
3705	JHS-15 (No5)	15	1.00	15.5	12 - 35	Beyaz	10	250	18,90

MALZEME: PE

Esnek yapısı sayesinde kabloların düzenlemesine yardımcı olur
Güçlü yapısı sayesinde tekrar kullanım için uygundur



YENİ ÜRÜN

Sipariş Kodu	Ürün Kodu	ÜRÜN AÇIKLAMASI	İÇ ÖLÇÜ	DIŞ ÖLÇÜ	Renk	RULO METRAJ	Birim Fiyat TL/Metre
7732	JKTS-1	20 LİK KABLO TOPLAMA SİRALİ	16MM	18MM	Gri	1.5MT	110,00
7734	JKTS-2	20 LİK KABLO TOPLAMA SİRALİ	16MM	18MM	Siyah	1.5MT	109,00
7735	JKTS-3	25 LİK KABLO TOPLAMA SİRALİ	22MM	25MM	Gri	1.5MT	112,00
7736	JKTS-4	25 LİK KABLO TOPLAMA SİRALİ	22MM	25MM	Siyah	1.5MT	111,00
7737	JKTS-5	30 LUK KABLO TOPLAMA SİRALİ	27MM	30MM	Gri	1.5MT	151,00
7738	JKTS-6	30 LUK KABLO TOPLAMA SİRALİ	27MM	30MM	Siyah	1.5MT	143,00
7739	JKTS-7	20 LİK KABLO TOPLAMA SİRALİ	16MM	18MM	Gri	25MT	51,00
7740	JKTS-8	20 LİK KABLO TOPLAMA SİRALİ	16MM	18MM	Siyah	25MT	50,00
7741	JKTS-9	25 LİK KABLO TOPLAMA SİRALİ	22MM	25MM	Gri	20MT	58,00
7742	JKTS-10	25 LİK KABLO TOPLAMA SİRALİ	22MM	25MM	Siyah	20MT	55,30
7742	JKTS-11	30 LUK KABLO TOPLAMA SİRALİ	27MM	30MM	Gri	15MT	70,00
7743	JKTS-12	30 LUK KABLO TOPLAMA SİRALİ	27MM	30MM	Siyah	15MT	69,25



JAMESON[®]

**KABLO
YÜKSÜKLERİ
TEK VE ÇİFT GİRİŞLİ**

www.kivilcimelektrik.com.tr

İZOLELİ KABLO YÜKSÜKLERİ FRANSIZ NORMU

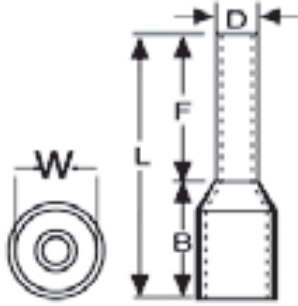

STANDART: DIN 46228

MALZEME: Bakır, Kalay Kaplı

İZOLASYON: Naylon

ÇALIŞMA SICAKLIĞI:
Maksimum 105 ° 600 volt Arası



Sipariş Kodu	Ürün Kodu	Renk	Kablo Kesit (mm ²)	Ebatlar (mm)					Kutuj Adet	Birim Fiyat TL / Adet	
				F	L	W	B	D			
3801	JYF-0.25		Menekşe	0.25 mm ²	8.0	12.0	1.9	4.4	1.1	1.000	0,650
3802	JYF-0.34		Pembe	0.34 mm ²	8.0	12.0	1.9	4.4	1.1	1.000	0,650
3803	JYF-0.50		Beyaz	0.50 mm ²	8.0	14.0	2.6	6.0	1.3	1.000	0,290
3804	JYF-0.75		Mavi	0.75 mm ²	8.0	14.0	2.8	6.3	1.5	1.000	0,290
3805	JYF-1.0		Kırmızı	1.00 mm ²	8.0	14.0	3.0	6.3	1.7	1.000	0,290
3806	JYF-1.5		Siyah	1.50 mm ²	8.0	14.0	3.5	6.3	2.0	1.000	0,320
3807	JYF-2.5		Gri	2.50 mm ²	8.0	14.0	4.2	7.4	2.5	500	0,410
3808	JYF-4.0		Turuncu	4.00 mm ²	10.0	17.0	4.8	7.4	3.2	500	0,690
3809	JYF-6.0		Yeşil	6.00 mm ²	12.0	20.0	6.3	8.5	3.9	250	0,930
3810	JYF-10.0		Kahve	10.0 mm ²	12.0	20.0	6.3	8.5	3.9	100	1,180
3811	JYF-16.0		Bej	16.0 mm ²	12.0	24.0	8.8	10.0	6.2	100	1,640
3812	JYF-25.0		Siyah	25.0 mm ²	16.0	28.0	11.2	12.0	7.7	50	2,750
3813	JYF-35.0		Kırmızı	35.0 mm ²	16.0	30.0	12.7	14.0	8.7	50	3,420
3814	JYF-50.0		Mavi	50.0 mm ²	20.0	36.0	15.0	16.0	10.9	25	6,480
3815	JYF-70.0		Sarı	70.0 mm ²	21.0	37.0	16.0	17.0	14.3	25	12,000
3830	JYF-95.0		Kırmızı	95.0 mm ²	20.0	36.0	15.0	16.0	10.9	25	12,700

İZOLELİ KABLO YÜKSÜKLERİ ALMAN NORMU

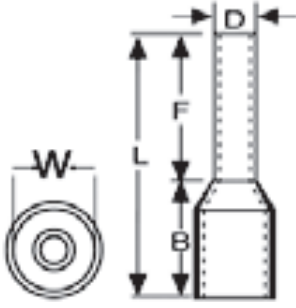

STANDART: DIN 46228

MALZEME: Bakır, Kalay Kaplı

İZOLASYON: Naylon

ÇALIŞMA SICAKLIĞI:
Maksimum 105 ° 600 volt Arası



Sipariş Kodu	Ürün Kodu	Renk	Kablo Kesit (mm ²)	Ebatlar (mm)					Kutu Adet	Birim Fiyat TL / Adet	
				F	L	W	B	D			
3816	JYA-0.25		Mavi	0.25 mm ²	8.0	12.0	1.6	2.8	0.9	1.000	0,650
3817	JYA-0.34		Turkuaz	0.34 mm ²	8.0	12.0	1.9	4.4	1.1	1.000	0,650
3818	JYA-0.50		Turuncu	0.50 mm ²	8.0	12.0	1.9	4.4	1.1	1.000	0,290
3819	JYA-0.75		Beyaz	0.75 mm ²	8.0	14.0	2.6	6.0	1.3	1.000	0,290
3820	JYA-1.0		Sarı	1.00 mm ²	8.0	14.0	2.8	6.3	1.5	1.000	0,290
3821	JYA-1.5		Kırmızı	1.50 mm ²	8.0	14.0	3.0	6.3	1.7	1.000	0,320
3822	JYA-2.5		Mavi	2.50 mm ²	8.0	14.0	3.5	6.3	2.0	500	0,410
3823	JYA-4.0		Gri	4.00 mm ²	8.0	14.0	4.2	7.4	2.5	500	0,690
3824	JYA-6.0		Siyah	6.00 mm ²	10.0	17.0	4.8	7.4	3.2	250	0,930
3825	JYA-10.0		Bej	10.0 mm ²	12.0	20.0	6.3	8.5	3.9	100	1,180
3826	JYA-16.0		Yeşil	16.0 mm ²	12.0	22.0	7.6	8.8	4.9	100	1,640
3827	JYA-25.0		Kahve	25.0 mm ²	12.0	24.0	8.8	10.0	6.2	50	2,750
3828	JYA-35.0		Bej	35.0 mm ²	16.0	28.0	11.2	12.0	7.7	50	3,420
3829	JYA-50.0		Yeşil	50.0 mm ²	16.0	30.0	12.7	14.0	8.7	25	6,480

ÇİFT GİRİŞLİ KABLO YÜKSÜKLERİ FRANSIZ NORMU

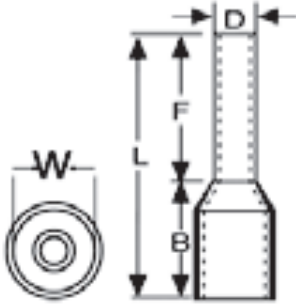
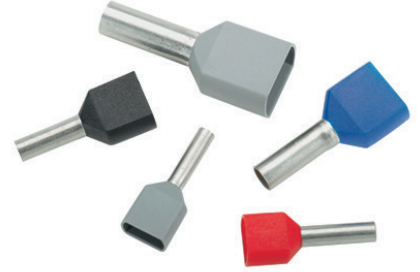
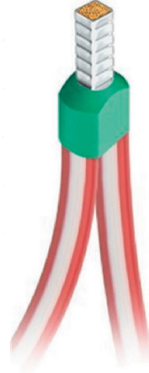
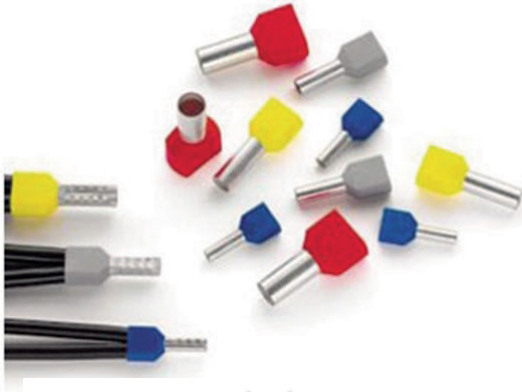

STANDART: DIN 46228

MALZEME: Bakır, Kalay Kaplı

İZOLASYON: Naylon

ÇALIŞMA SICAKLIĞI:
Maksimum 105 ° 600 volt Arası



Sipariş Kodu	Ürün Kodu	Renk	Kablo Kesit (mm ²)	Ebatlar (mm)					Kutuj Adet	Birim Fiyat TL / Adet
				F	L	W	B	D		
3831	JCY-0.50F	Beyaz	0.50 mm ²	8.0	14.0	5.0	6.5	1.8	1.000	0,520
3832	JCY-0.75F	Mavi	0.75 mm ²	8.0	14.0	5.5	6.7	2.1	500	0,550
3833	JCY-1.0F	Kırmızı	1.00 mm ²	8.0	14.0	5.5	7.1	2.4	500	0,590
3834	JCY-1.5F	Siyah	1.50 mm ²	8.0	14.0	6.4	7.5	2.6	500	0,710
3835	JCY-2.5F	Gri	2.50 mm ²	10.0	14.0	8.0	8.5	3.3	250	1,140
3836	JCY-4.0F	Turuncu	4.00 mm ²	12.0	17.0	8.0	11.1	4.2	200	1,320
3837	JCY-6.0F	Yeşil	6.00 mm ²	14.0	20.0	9.5	12.1	5.3	100	1,640
3838	JCY-10.0F	Kahve	10.0 mm ²	14.0	27.0	12.6	12.6	6.9	50	2,520
3839	JCY-16.0F	Bej	16.0 mm ²	14.0	31.0	19.0	17.3	8.7	50	3,200

ÇİFT GİRİŞLİ KABLO YÜKSÜKLERİ ALMAN NORMU

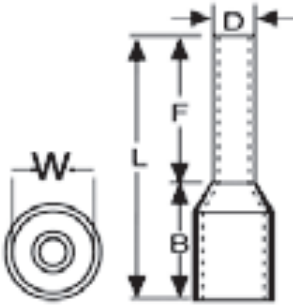
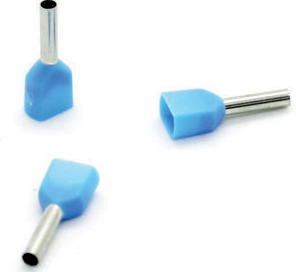

STANDART: DIN 46228

MALZEME: Bakır, Kalay Kaplı

İZOLASYON: Naylon

ÇALIŞMA SICAKLIĞI:
Maksimum 105 ° 600 volt Arası



Sipariş Kodu	Ürün Kodu	Renk	Kablo Kesit (mm ²)	Ebatlar (mm)					Kutuj Adet	Birim Fiyat TL / Adet
				F	L	W	B	D		
3840	JCY-0.50A	Turuncu	0.50 mm ²	8.0	14.0	5.0	6.5	1.8	1.000	0,520
3841	JCY-0.75A	Beyaz	0.75 mm ²	8.0	14.0	5.5	6.7	2.1	500	0,550
3842	JCY-1.0A	Sarı	1.00 mm ²	8.0	14.0	5.5	7.1	2.4	500	0,590
3843	JCY-1.5A	Kırmızı	1.50 mm ²	8.0	14.0	6.4	7.5	2.6	500	0,710
3844	JCY-2.5A	Mavi	2.50 mm ²	10.0	14.0	8.0	8.5	3.3	250	1,140
3845	JCY-4.0A	Gri	4.00 mm ²	12.0	17.0	8.0	11.1	4.2	200	1,320
3846	JCY-6.0A	Siyah	6.00 mm ²	14.0	20.0	9.5	12.1	5.3	100	1,640
3847	JCY-10.0A	Bej	10.0 mm ²	14.0	27.0	12.6	12.6	6.9	50	2,520
3848	JCY-16.0A	Yeşil	16.0 mm ²	14.0	31.0	19.0	17.3	8.7	50	3,200

İZOLESİZ KABLO YÜKSÜKLERİ



STANDART: DIN 46228

MALZEME: Bakır, Kalay Kaplı

Sipariş Kodu	Ürün Kodu	Kablo Kesit (mm ²)	Ebatlar (mm)				Kutuj Adet	Birim Fiyat TL / Adet
			L	W	D	C		
3849	JKY-050	0.50 mm ²	10	2.1	1.3	1.0	2.000	0,300
3850	JKY-075	0.75 mm ²	10	2.3	1.5	1.2	1.000	0,300
3851	JKY-1.0	1.00 mm ²	10	2.5	1.7	1.4	1.000	0,300
3852	JKY-1.5	1.50 mm ²	10	2.8	2.0	1.7	1.000	0,330
3853	JKY-2.5	2.50 mm ²	12	3.4	2.5	2.2	1.000	0,450
3854	JKY-4.0	4.00 mm ²	12	4.0	3.2	2.8	1.000	0,610
3855	JKY-6.0	6.00 mm ²	12	4.7	3.9	3.5	500	0,830
3856	JKY-10.0	10.0 mm ²	15	5.8	4.9	4.5	250	1,380
3857	JKY-16.0	16.0 mm ²	15	7.5	6.2	5.8	250	1,740
3858	JKY-25.0	25.0 mm ²	16	9.1	7.9	7.5	100	2,640
3859	JKY-35.0	35.0 mm ²	16	10.2	8.7	8.3	100	3,000
3860	JKY-50.0	50.0 mm ²	22	12.7	10.9	10.3	50	6,240
3861	JKY-70.0	70.0 mm ²	25.2	13.5	5.36	4.68	50	7,050
3862	JKY-95.0	95.0 mm ²	25.2	14.0	5.38	5.35	25	8,100



JAMESON®

KABLO UÇLARI VE TERMİNALLERİ

www.kivilcimelektrik.com.tr

YUVARLAK TİP İZOLELİ KABLO UÇLARI

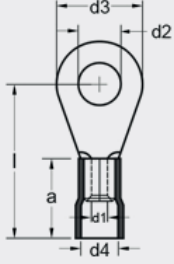

Standart : DIN 46237
 Malzeme : Bakır, Kalay Kaplı
 İzolasyon : PVC
 Çalışma Sıcaklığı : Maksimum 105° 600Volt Arası



Sipariş Kodu	Ürün Kodu	Renk	Kablo Kesit (mm ²)	Civata Ölçüsü	Ebatlar (mm)						Kutu Adet	Birim Fiyat TL / Adet
					d2	d3	l	d1	d4	a		
3901	JYU-301	■ Kırmızı	0.50 - 1.50 mm ²	M3	3.2	6.0	16.0	1.6	4.0	10.0	200	0,940
3902	JYU-401	■ Kırmızı		M4	4.3	8.0	17.0	1.6	4.0	10.0	200	1,400
3903	JYU-501	■ Kırmızı		M5	5.3	10.0	18.0	1.6	4.0	10.0	200	1,420
3904	JYU-601	■ Kırmızı		M6	6.5	10.0	18.0	1.6	4.0	10.0	200	2,250
3905	JYU-801	■ Kırmızı		M8	8.4	14.0	22.0	1.6	4.0	10.0	200	2,250

Sipariş Kodu	Ürün Kodu	Renk	Kablo Kesit (mm ²)	Civata Ölçüsü	Ebatlar (mm)						Kutu Adet	Birim Fiyat TL / Adet
					d2	d3	l	d1	d4	a		
3906	JYU-302	■ Mavi	1.50 - 2.50 mm ²	M3	3.2	6.0	16.0	2.3	4.5	10.0	200	1,740
3907	JYU-402	■ Mavi		M4	4.3	8.0	17.0	2.3	4.5	10.0	200	1,740
3908	JYU-502	■ Mavi		M5	5.3	10.0	19.0	2.3	4.5	10.0	200	1,760
3910	JYU-602	■ Mavi		M6	6.5	11.0	20.0	2.3	4.5	10.0	200	2,500
3911	JYU-802	■ Mavi		M8	8.4	14.0	22.0	2.3	4.5	10.0	200	2,500
3912	JYU-1002	■ Mavi		M10	10.5	15.0	22.0	2.3	4.5	10.0	200	2,600

Sipariş Kodu	Ürün Kodu	Renk	Kablo Kesit (mm ²)	Civata Ölçüsü	Ebatlar (mm)						Kutu Adet	Birim Fiyat TL / Adet
					d2	d3	l	d1	d4	a		
3913	JYU-406	■ Sarı	4.00 - 6.00 mm ²	M4	4.3	8.6	21.0	3.6	6.3	13.0	100	3,700
3914	JYU-506	■ Sarı		M5	5.3	10.0	22.0	3.6	6.3	13.0	100	3,700
3915	JYU-606	■ Sarı		M6	6.5	11.0	22.5	3.6	6.3	13.0	100	4,200
3916	JYU-806	■ Sarı		M8	8.4	14.0	26.0	3.6	6.3	13.0	100	5,400
3917	JYU-1006	■ Sarı		M10	10.5	18.0	28.0	3.6	6.3	13.0	100	5,450
3918	JYU-1206	■ Sarı		M12	13.0	18.0	28.0	3.6	6.3	13.0	100	5,550
3919	JYU-610	■ Kırmızı	8.00 - 10.00 mm ²	M6	6.7	23.5	30.0	4.5	8.0	17.0	50	6,000
3920	JYU-810	■ Kırmızı		M8	8.4	26.3	36.0	4.5	8.0	17.0	50	7,500

ÇATAL TİP İZOLELİ KABLO UÇLARI

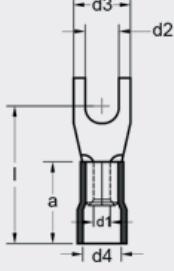

Standart : DIN 46237
 Malzeme : Bakır, Kalay Kaplı
 İzolasyon : PVC
 Çalışma Sıcaklığı : Maksimum 105° 600Volt Arası



Sipariş Kodu	Ürün Kodu	Renk	Kablo Kesit (mm ²)	Civata Ölçüsü	Ebatlar (mm)						Kutu Adet	Birim Fiyat TL / Adet
					d2	d3	l	d1	d4	a		
3921	JÇU-3001	■ Kırmızı	0.50 - 1.50 mm ²	M3	3.2	6.0	16.0	1.6	4.0	10.0	200	1,280
3922	JÇU-4001	■ Kırmızı		M4	4.3	8.0	17.0	1.6	4.0	10.0	200	1,320
3923	JÇU-5001	■ Kırmızı		M5	5.3	10.0	18.0	1.6	4.0	10.0	200	1,380
3924	JÇU-6001	■ Kırmızı		M6	6.5	11.0	20.0	1.6	4.0	10.0	200	1,560

Sipariş Kodu	Ürün Kodu	Renk	Kablo Kesit (mm ²)	Civata Ölçüsü	Ebatlar (mm)						Kutu Adet	Birim Fiyat TL / Adet
					d2	d3	l	d1	d4	a		
3925	JÇU-3002	■ Mavi	1.50 - 2.50 mm ²	M3	3.2	5.5	18.0	2.3	4.5	10.0	200	1,440
3926	JÇU-4002	■ Mavi		M4	4.3	6.8	17.0	2.3	4.5	10.0	200	1,480
3927	JÇU-5002	■ Mavi		M5	5.3	10.0	19.0	2.3	4.5	10.0	200	1,500
3928	JÇU-6002	■ Mavi		M6	6.5	11.0	21.0	2.3	4.5	10.0	200	2,000

Sipariş Kodu	Ürün Kodu	Renk	Kablo Kesit (mm ²)	Civata Ölçüsü	Ebatlar (mm)						Kutu Adet	Birim Fiyat TL / Adet
					d2	d3	l	d1	d4	a		
3929	JÇU-4006	■ Sarı	4.00 - 6.00 mm ²	M4	4.3	8.0	21.0	3.6	13.0	10.0	100	3,250
3930	JÇU-5006	■ Sarı		M5	5.3	10.0	22.0	3.6	6.3	13.0	100	3,300
3931	JÇU-6006	■ Sarı		M6	6.5	11.0	23.0	3.6	6.3	13.0	100	4,400
3932	JÇU-8006	■ Sarı		M8	8.4	14.0	26.0	3.6	6.3	13.0	100	5,150

EK MUFLARI İZOLELİ KABLO UÇLARI

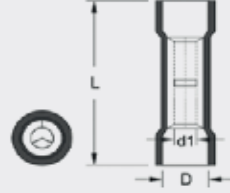

STANDART: DIN 46237
MALZEME: Bakır, Kalay Kaplı
İZOLASYON: PVC
ÇALIŞMA SICAKLIĞI: Maksimum 75° 600 Volt Arası

Sipariş Kodu	Ürün Kodu	Renk	Kablo Kesit (mm ²)	Ebatlar (mm)			Kutu Adet	Birim Fiyat TL / Adet
				L	D	d1		
3933	JBY-251	Kırmızı	0.50 - 1.50 mm ²	24.6	4.0	1.7	200	2,000
3934	JBY-252	Mavi	1.50 - 2.50 mm ²	24.6	4.5	2.3	200	2,000
3935	JBY-256	Sarı	4.00 - 6.00 mm ²	26.5	6.3	3.4	100	3,400

ERKEK TERMİNALLER İZOLELİ KABLO UÇLARI

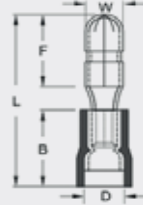

MALZEME: Pirinç, Kalay Kaplı, Bakır Yüksüklü
İZOLASYON: PVC
ÇALIŞMA SICAKLIĞI: Maksimum 75° 600 Volt Arası

Sipariş Kodu	Ürün Kodu	Renk	Kablo Kesit (mm ²)	Ebatlar (mm)					Kutu Adet	Birim Fiyat TL / Adet
				W	F	L	B	D		
3936	JBE-1041	Kırmızı	0.50 - 1.50 mm ²	4.0	8.5	21.5	10.5	3.8	200	3,300
3937	JBE-2052	Mavi	1.50 - 2.50 mm ²	5.0	8.5	21.2	10.5	4.7	200	3,800
3938	JBE-5056	Sarı	4.00 - 6.00 mm ²	5.0	8.5	24.0	13.0	6.2	200	5,100

DIŞI TERMİNALLER İZOLELİ KABLO UÇLARI

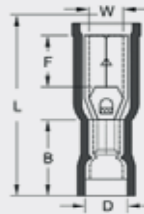

MALZEME: Pirinç, Kalay Kaplı, Bakır Yüksüklü
İZOLASYON: PVC
ÇALIŞMA SICAKLIĞI: Maksimum 75° 600 Volt Arası

Sipariş Kodu	Ürün Kodu	Renk	Kablo Kesit (mm ²)	Ebatlar (mm)					Kutu Adet	Birim Fiyat TL / Adet
				W	F	L	B	D		
3939	JBD-1041	Kırmızı	0.50 - 1.50 mm ²	3.9	7.0	23.3	10.5	3.8	200	4,000
3940	JBD-2052	Mavi	1.50 - 2.50 mm ²	4.9	7.0	23.3	10.5	4.7	100	4,500
3941	JBD-5056	Sarı	4.00 - 6.00 mm ²	4.9	7.0	25.1	12.5	6.2	100	5,600

DIŐI FASTON TİP İZOLELİ KABLO UÇLARI

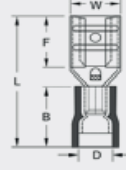

MALZEME: Piriç, Kalay Kaplı
İZOLASYON: PVC
ÇALIŐMA SICAKLIĐI: Maksimum 75° 600 Volt Arası

SipariŐ Kodu	Ürün Kodu	Renk	Kablo Kesit (mm ²)	Soket GeniŐliĐi	Ebatlar (mm)					Kutu Adet	Birim Fiyat TL / Adet
					W	F	L	B	D		
3942	JFD-1288	Kırmızı	0.50 - 1.50 mm ²	0.8 x 2.80	3.2	6.5	19.0	10.5	3.8	200	0,890
3943	JFD-1488	Kırmızı		0.8 x 4.75	5.0	6.4	19.4	10.5	3.8	200	1,150
3944	JFD-1638	Kırmızı		0.8 x 6.35	6.6	7.5	20.8	10.5	3.8	200	1,470
3945	JFD-2288	Mavi	1.50 - 2.50 mm ²	0.8 x 2.80	3.2	6.5	19.0	10.5	3.8	200	1,150
3946	JFD-2488	Mavi		0.8 x 4.75	5.0	6.4	19.4	10.5	3.8	200	1,200
3947	JFD-2638	Mavi		0.8 x 6.35	6.6	7.5	20.8	10.5	3.8	200	1,500
3948	JFD-5638	Sarı	4.00 - 6.00 mm ²	0.8 x 6.35	6.6	7.5	23.3	13.0	6.2	200	1,700

TAM İZOLELİ DIŐI FASTON TİP KABLO UÇLARI

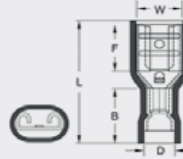

MALZEME: Piriç, Kalay Kaplı
İZOLASYON: PVC
ÇALIŐMA SICAKLIĐI: Maksimum 75° 600 Volt Arası

SipariŐ Kodu	Ürün Kodu	Renk	Kablo Kesit (mm ²)	Soket GeniŐliĐi	Ebatlar (mm)					Kutu Adet	Birim Fiyat TL / Adet
					W	F	L	B	D		
3949	JFFD-1288	Kırmızı	0.50 - 1.50 mm ²	0.8 x 2.80	3.2	6.5	19.0	10.5	3.8	200	1,440
3950	JFFD-1488	Kırmızı		0.8 x 4.75	5.0	6.4	20.8	10.5	3.8	200	1,700
3951	JFFD-1638	Kırmızı		0.8 x 6.35	6.6	7.5	21.8	10.5	3.8	200	2,000
3952	JFFD-2288	Mavi	1.50 - 2.50 mm ²	0.8 x 2.80	3.2	6.5	20.0	10.5	4.7	200	1,700
3953	JFFD-2488	Mavi		0.8 x 4.75	5.0	6.4	20.2	10.5	4.7	200	1,750
3954	JFFD-2638	Mavi		0.8 x 6.35	6.6	7.5	22.2	10.5	4.7	200	2,100
3955	JFFD-5638	Sarı	4.00 - 6.00 mm ²	0.8 x 6.35	6.6	7.5	24.2	12.5	6.2	100	2,400

TAM İZOLELİ POLYAMİD DIŐI FASTON TİP KABLO UÇLARI

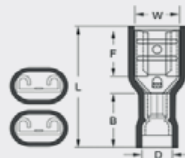

MALZEME: Piriç, Kalay Kaplı
İZOLASYON: Polyamid
ÇALIŐMA SICAKLIĐI: Maksimum 75° 600 Volt Arası

SipariŐ Kodu	Ürün Kodu	Renk	Kablo Kesit (mm ²)	Soket GeniŐliĐi	Ebatlar (mm)					Kutu Adet	Birim Fiyat TL / Adet
					W	F	L	B	D		
3956	JPFD-1638	Kırmızı	0.50 - 1.50 mm ²	0.8 x 6.35	6.6	7.5	21.5	11.0	4.0	200	5,000
3957	JPFD-2638	Mavi	1.50 - 2.50 mm ²	0.8 x 6.35	6.6	7.5	21.5	11.0	5.0	200	5,000
3958	JPFD-5638	Sarı	4.00 - 6.00 mm ²	0.8 x 6.35	6.6	7.5	24.2	13.0	6.5	100	6,000

İĞNE TİP İZOLELİ KABLO UÇLARI

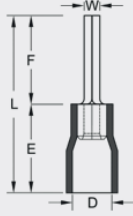

MALZEME: Bakır, Kalay Kaplı
İZOLASYON: PVC
ÇALIŞMA SICAKLIĞI: Maksimum 75° 600 Volt Arası



Sipariş Kodu	Ürün Kodu	Renk	Kablo Kesit (mm ²)	Ebatlar (mm)					Kutu Adet	Birim Fiyat TL / Adet
				W	F	L	B	D		
3959	JIK-101	■ Kırmızı	0.50 - 1.50 mm ²	1.9	10.0	19.0	10.0	4.0	200	1,500
3960	JIK-102	■ Mavi	1.50 - 2.50 mm ²	1.9	12.0	21.8	10.0	4.5	200	1,800
3961	JIK-106	■ Sarı	4.00 - 6.00 mm ²	2.8	14.0	27.0	27.0	6.4	100	4,300

ERKEK / DIŞİ GERİ DÖNÜŞLÜ TERMİNALER

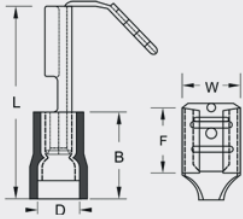

MALZEME: Pirinç, Kalay Kaplı
İZOLASYON: PVC
ÇALIŞMA SICAKLIĞI: Maksimum 75° 600 Volt Arası



Sipariş Kodu	Ürün Kodu	Renk	Kablo Kesit (mm ²)	Soket Genişliği	Ebatlar (mm)					Kutu Adet	Birim Fiyat TL / Adet
					W	F	L	B	D		
3962	JFDEG-1861	■ Kırmızı	0.50 - 1.50 mm ²	0.8 x 2.80	6.6	8.0	22.5	10.5	3.8	100	2,800
3963	JFDEG-2862	■ Mavi	1.50 - 2.50 mm ²	0.8 x 4.75	6.6	8.0	22.5	10.5	4.7	100	2,900
3964	JFDEG-5866	■ Sarı	4.00 - 6.00 mm ²	0.8 x 6.35	6.6	8.0	24.0	13.0	6.2	100	3,300

TAM İZOLELİ POLYAMİD BAYRAK TİP TERMİNALER

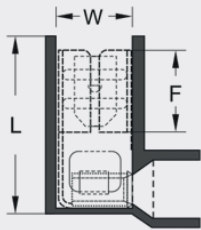

MALZEME: Pirinç, Kalay Kaplı
İZOLASYON: Polyamid
ÇALIŞMA SICAKLIĞI: Maksimum 75° 600 Volt Arası



Sipariş Kodu	Ürün Kodu	Renk	Kablo Kesit (mm ²)	Ebatlar (mm)			Kutu Adet	Birim Fiyat TL / Adet
				W	F	L		
3965	JPFDEB-1861	■ Kırmızı	0.8 x 6.35	6.6	7.6	16.0	100	3,750
3966	JPFDEB-2862	■ Mavi	0.8 x 6.35	6.6	7.6	16.0	100	3,750

ERKEK FASTON TİP KABLO UÇLARI

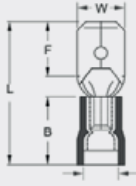

MALZEME: Pirinç, Kalay Kaplı
İZOLASYON: PVC
ÇALIŞMA SICAKLIĞI: Maksimum 75° 600 Volt Arası



Sipariş Kodu	Ürün Kodu	Renk	Kablo Kesit (mm ²)	Soket Geniřliđi	Ebatlar (mm)					Kutu Adet	Birim Fiyat TL / Adet
					W	F	L	B	D		
3967	JFE-1288	Kırmızı	0.50 - 1.50 mm ²	0.8 x 2.80	2.8	6.5	19.2	10.5	3.8	200	0,950
3968	JFE-1488	Kırmızı		0.8 x 4.75	4.8	6.7	19.8	10.5	3.8	200	1,080
3969	JFE-1638	Kırmızı		0.8 x 6.35	6.35	6.35	21.8	10.5	3.8	200	1,380
3970	JFE-2288	Mavi	1.50 - 2.50 mm ²	0.8 x 2.80	2.8	6.7	19.8	10.5	4.7	200	0,950
3971	JFE-2488	Mavi		0.8 x 4.75	4.8	6.7	19.8	10.5	4.7	200	1,200
3972	JFE-2638	Mavi		0.8 x 6.35	6.35	7.7	21.8	10.5	4.7	200	1,440
3973	JFE-5638	Sarı	4.00 - 6.00 mm ²	0.8 x 6.35	6.35	7.7	24.8	13.0	6.2	200	1,700

VİDALI BUAT KLEMENSLERİ

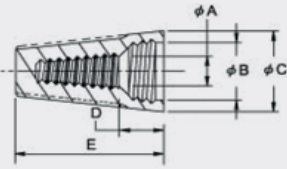

MALZEME: Pirinç, Kalay Kaplı
İZOLASYON: PVC
ÇALIŞMA SICAKLIĞI: Maksimum 75° 600 Volt Arası



Sipariş Kodu	Ürün Kodu	Renk	Ebatlar (mm)					Kutu Adet	Birim Fiyat TL / Adet
			A	B	C	D	E		
3974	J-1	Gri	3.8	6.70	8.60	5.80	15.20	1.000	0,715
3975	J-2	Mavi	4.10	7.00	9.80	5.90	17.60	1.000	0,825
3976	J-3	Turuncu	5.00	9.90	12.20	7.80	22.00	500	1,220
3977	J-4	Sarı	6.00	11.20	14.00	7.90	24.00	500	2,020
3978	J-6	Kırmızı	7.50	13.00	16.40	9.15	26.50	500	3,010

HIZLI KABLO EKLEME PARÇASI

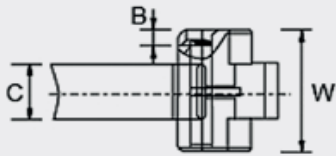

MALZEME: Pirinç, Kalay Kaplı
İZOLASYON: Naylon
ÇALIŞMA SICAKLIĞI: Maksimum 75° 600 Volt Arası

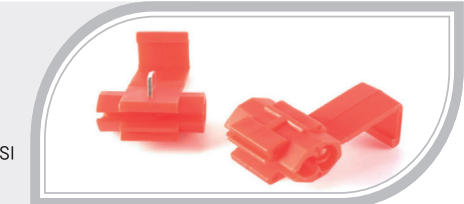

Sipariş Kodu	Ürün Kodu	Renk	Kablo Kesit (mm ²)	Ebatlar (mm)			Kutu Adet	Birim Fiyat TL / Adet
				W	F	L		
3979	JP-1	Kırmızı	0.50 - 1.00	4.0	10.6	20.0	500	1,835
3980	JP-2	Mavi	1.50 - 2.50	4.0	10.6	20.0	500	1,835
3981	JP-5	Sarı	4.00 - 6.00	4.0	2.0	20.0	250	2,980

İZOLESİZ KABLO UCU VE KONNEKTÖRLERİ

SİPARİŞ KODU	4001	4002	4003	4004	4005
ÜRÜN KODU	JF1/2D	JF1D MİNİ	JF1D	JF3D	JF2D TRK
AÇIKLAMA	2.8 Mikro Dişi Terminal	4.8 Mini Dişi Terminal	6.3 Dişi Terminal	9.5 Dişi Terminal	6.3 Tırnaklı Dişi Terminal
KUTU ADET	1.000	500	300	100	300
BİRİM FİYATI TL./Ad.	0,690	0,840	1,080	3,100	1,080
SİPARİŞ KODU	4006	4007	4008	4009	4010
ÜRÜN KODU	JF1D EĞRİ	JF1D E	JKN 1-03	JKN 1-04	JKN 2.5-04
AÇIKLAMA	6.3 Eğri Dişi Terminal	6.3 Erkek Geri Dönüşümlü Terminal	M3 Topraklama Terminali	M4 Topraklama Terminali	M4 Topraklama Terminali
KUTU ADET	250	200	500	500	500
BİRİM FİYATI TL./Ad.	1,400	2,700	1,030	1,030	1,035
SİPARİŞ KODU	4011	4012	4013	4014	4015
ÜRÜN KODU	JKN 2.5-05	JKN 2.5-06	JKN 4-04	JKN 4-05	JKN 4-06
AÇIKLAMA	M5 Topraklama Terminali	M6 Topraklama Terminali	M4 Topraklama Terminali	M5 Topraklama Terminali	M6 Topraklama Terminali
KUTU ADET	500	500	250	250	250
BİRİM FİYATI TL./Ad.	1,050	1,050	1,975	1,975	1,975
SİPARİŞ KODU	4016	4017	4018	4019	4020
ÜRÜN KODU	JKN 6-06	JKN 8-08	JKN 10-10	JK 2.5	JK 4
AÇIKLAMA	M6 Topraklama Terminali	M8 Topraklama Terminali	M10 Topraklama Terminali	Boru Tip Topraklama Terminali	Boru Tip Topraklama Terminali
KUTU ADET	150	150	100	1.000	500
BİRİM FİYATI TL./Ad.	3,100	3,100	3,500	1,000	1,650
SİPARİŞ KODU	4021	4022	4023	4024	4025
ÜRÜN KODU	JK 6	JF1E ÇK	JF1EU1	R TİPİ KONNEKTÖR	JF1D KILIF
AÇIKLAMA	Boru Tip Topraklama Terminali	6.3 Erkek Terminal	6.3 Uzun Erkek Terminal	6.3 Kilitli Konnektör	6.3 Terminal Kılıfı
KUTU ADET	250	300	300	300	300
BİRİM FİYATI TL./Ad.	2,300	1,100	1,380	0,800	0,580

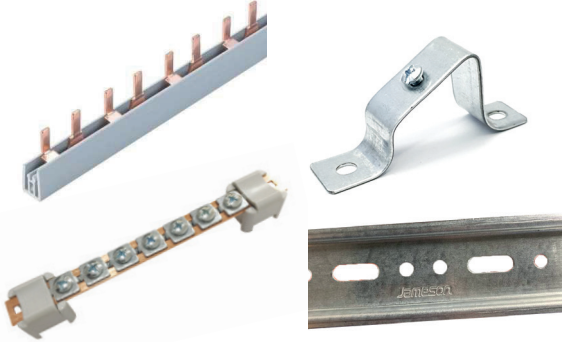

JAMESON[®]

BAĞLANTI ELEMENLARI

www.kivilcimelektrik.com.tr

SKP-E EKONOMİK TİP KABLO PABUCU

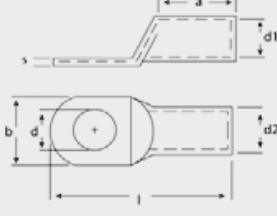

MALZEME: EN13600 Standart Bakır
Yüzey: Kalay



Sipariş Kodu	Ürün Kodu	Kablo Kesit (mm ²)	Delik Çapı ø	Ebatlar (mm)						Kutu Adet	Birim Fiyat TL / Adet
				d	d1	d2	l	a	b		
4101	SKP-E 16-6	16 mm ²	M6	6.5	5.5	7.0	32.5	11.0	10.0	500	9,00
4102	SKP-E 16-8		M8	8.5	5.5	7.0	32.5	11.0	10.0	500	9,00
4103	SKP-E 25-6	25 mm ²	M6	6.5	7.0	9.0	38.5	16.0	13.0	400	17,00
4104	SKP-E 25-8		M8	8.5	7.0	9.0	38.5	16.0	13.0	400	17,00
4105	SKP-E 35-6	35 mm ²	M6	6.5	8.5	10.5	43.5	19.0	15.5	300	23,00
4106	SKP-E 35-8		M8	8.3	8.5	10.5	43.5	19.0	15.5	300	23,00
4107	SKP-E 50-8	50 mm ²	M8	8.5	10.0	12.0	51.5	21.0	17.6	200	32,00
4108	SKP-E 50-10		M10	10.5	10.0	12.0	51.5	21.0	17.6	200	32,00
4109	SKP-E 70-10	70 mm ²	M10	10.5	11.5	14.0	55.5	23.0	20.7	100	49,00
4110	SKP-E 70-12		M12	13.0	11.5	14.0	55.5	23.0	20.7	100	49,00
4111	SKP-E 95-10	95 mm ²	M10	10.5	13.5	16.0	58.5	26.0	23.5	75	60,00
4112	SKP-E 95-12		M12	13.0	13.5	16.0	58.5	26.0	23.5	75	60,00
4113	SKP-E 120-10	120 mm ²	M10	10.5	15.5	18.0	71.0	29.0	26.7	50	82,00
4114	SKP-E 120-12		M12	13.0	15.5	18.0	71.0	29.0	26.7	50	82,00
4115	SKP-E 150-10	150 mm ²	M10	10.5	16.5	20.0	76.0	30.0	29.2	40	136,00
4116	SKP-E 150-12		M12	13.0	16.5	20.0	76.5	30.0	29.2	40	136,00
4117	SKP-E 185-12	185 mm ²	M12	13.0	18.5	22.0	82.0	33.0	32.3	30	160,00
4118	SKP-E 185-16		M16	17.0	18.5	22.0	82.0	33.0	32.3	30	160,00
4119	SKP-E 240-12	240 mm ²	M12	13.0	21.5	25.5	91.0	38.0	37.6	25	236,00
4120	SKP-E 240-16		M16	17.0	21.5	25.5	91.0	38.0	37.6	25	236,00

SKP-S STANDART TİP KABLO PABUCU

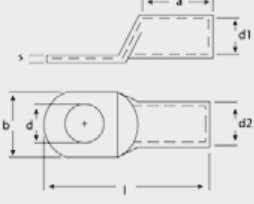

MALZEME: EN13600 Standart Bakır
Yüzey: Kalay



Sipariş Kodu	Ürün Kodu	Kablo Kesit (mm ²)	Delik Çapı ø	Ebatlar (mm)								Kutu Adet	Birim Fiyat TL / Adet	
				d	d1	d2	l	l1	a	b	c1			c2
4121	SKP-S 10-5	10 mm ²	M5	5.5	4.4	6.0	27.5	21.6	10.0	10.3	6.0	6.0	1000	9,00
4122	SKP-S 10-6		M6	6.5	4.4	6.0	27.5	21.6	10.0	10.3	6.0	6.0	1000	9,00
4123	SKP-S 10-8		M8	8.5	4.4	6.0	27.5	21.6	10.0	13.5	6.0	6.0	1000	9,00
4124	SKP-S 16-6	16 mm ²	M6	6.5	5.5	8.0	32.6	25.0	12.0	11.2	7.0	8.0	500	12,50
4125	SKP-S 16-8		M8	8.5	5.5	8.0	32.6	25.0	12.0	13.7	7.0	8.0	500	14,00
4126	SKP-S 16-10		M10	10.5	5.5	8.0	32.6	25.0	12.0	16.0	7.0	8.0	500	14,00
4127	SKP-S 25-6	25 mm ²	M6	6.5	6.8	9.0	39.0	32.2	16.0	13.5	6.8	9.2	400	22,00
4128	SKP-S 25-8		M8	8.5	6.8	9.0	39.0	32.2	16.0	13.5	6.8	9.2	400	22,00
4129	SKP-S 25-10		M10	10.5	7.0	9.5	42.0	34.0	16.0	16.0	6.8	11.0	400	23,00
4130	SKP-S 35-6	35 mm ²	M6	6.5	8.2	11.0	44.0	35.7	19.0	15.7	8.0	9.7	200	31,00
4131	SKP-S 35-8		M8	8.5	8.2	11.0	44.0	35.7	19.0	15.7	8.0	9.7	200	31,00
4132	SKP-S 35-10		M10	10.5	8.2	11.0	48.0	38.0	19.0	15.7	10.0	12.0	200	33,50
4133	SKP-S 50-8	50 mm ²	M8	8.5	9.5	12.0	47.5	39.2	21.0	17.7	8.3	9.7	150	44,50
4134	SKP-S 50-10		M10	10.5	9.5	12.0	51.5	41.5	21.0	17.7	10.0	12.0	150	48,00
4135	SKP-S 50-12		M12	13.0	10.1	13.0	51.5	41.5	21.0	19.0	10.0	12.0	150	48,00
4136	SKP-S 50-14		M14	15.0	10.1	13.0	56.5	44.5	21.0	20.5	12.0	15.0	150	48,00
4137	SKP-S 70-8	70 mm ²	M8	8.5	11.2	14.5	54.6	44.6	23.0	21.1	10.0	12.0	100	64,00
4138	SKP-S 70-10		M10	10.5	11.2	14.5	54.6	44.6	23.0	21.1	10.0	12.0	100	64,00
4139	SKP-S 70-12		M12	13.0	11.2	14.5	54.6	44.6	23.0	21.1	10.0	12.0	100	64,00
4140	SKP-S 70-14		M14	15.0	11.2	14.5	62.6	47.6	23.0	21.4	15.0	15.0	100	72,00
4141	SKP-S 95-8	95 mm ²	M8	8.5	13.4	17.0	58.8	48.8	26.0	24.5	10.0	12.0	75	79,00
4142	SKP-S 95-10		M10	10.5	13.4	17.0	58.8	48.8	26.0	24.5	10.0	12.0	75	79,00
4143	SKP-S 95-12		M12	13.0	13.4	17.0	58.8	48.8	26.0	24.5	10.0	12.0	75	79,00
4144	SKP-S 120-10	120 mm ²	M10	10.0	15.5	19.0	69.0	56.6	29.0	28.0	13.0	14.5	50	113,00
4145	SKP-S 120-12		M12	13.0	15.5	19.0	69.0	56.6	29.0	28.0	13.0	14.5	50	113,00
4146	SKP-S 120-16		M16	17.0	15.5	19.0	69.0	56.6	29.0	28.0	13.0	14.5	50	113,00
4147	SKP-S 150-10	150 mm ²	M10	10.5	16.5	16.5	76.5	60.0	30.0	30.0	16.5	16.5	40	178,00
4148	SKP-S 150-12		M12	13.0	16.5	21.0	76.5	60.0	30.0	30.0	16.5	16.5	40	178,00
4149	SKP-S 150-16		M16	17.0	16.5	21.0	76.5	60.0	30.0	30.0	16.5	16.5	40	178,00
4150	SKP-S 185-12	185 mm ²	M12	13.0	5.5	23.0	82.5	65.5	33.0	34.0	17.0	18.0	30	220,00
4151	SKP-S 185-16		M16	17.0	5.5	23.0	82.5	65.5	33.0	34.0	17.0	18.0	30	220,00
4152	SKP-S 240-12	240 mm ²	M12	13.0	5.5	26.0	89.0	72.0	38.0	38.0	17.0	18.0	25	288,00
4153	SKP-S 240-16		M16	17.0	5.5	26.0	89.0	72.0	38.0	38.0	17.0	18.0	25	288,00

BİMETALİK SIKMALI KABLO PAPUÇLARI



YENİ
ÜRÜN

Sipariş Kodu	Ürün Kodu	Kablo Kesit (mm ²)	Delik Çapı Ø	Ebatlar (mm)		Kutu Adet	Birim Fiyat TL / Adet
				d	l		
7360	JBM 16	16	M12	13.0	84.0	100	82,00
7361	JBM 25	25	M12	13.0	84.0	100	82,00
7362	JBM 35	35	M12	13.0	84.0	100	82,00
7363	JBM 50	50	M12	13.0	84.0	50	115,00
7364	JBM 70	70	M12	13.0	84.0	50	115,00
7365	JBM 95	95	M12	13.0	84.0	50	115,00
7366	JBM 120	120	M12	13.0	107.0	20	200,00
7367	JBM 150	150	M12	13.0	107.0	20	200,00
7368	JBM 185	185	M12	13.0	117.0	12	330,00
7369	JBM 240	240	M12	13.0	117.0	12	330,00
7370	JBM 300	300	M16	17.0	135.0	12	400,00
7371	JBM 400	400	M16	17.0	135.0	5	600,00

EK MUFLARI

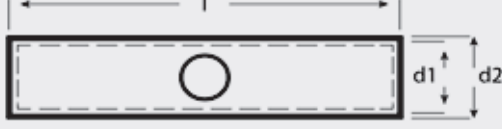

MALZEME: EN13600 Standart Bakır
YÜZEY: Kalay

Sipariş Kodu	Ürün Kodu	Kablo Kesit (mm ²)	Ebatlar (mm)			Kutu Adet	Birim Fiyat TL / Adet
			d1	d2	l		
4154	EKMUF - 10	10	4.4	6.0	27.0	1000	9,00
4155	EKMUF - 16	16	5.5	8.0	32.0	400	10,00
4156	EKMUF - 25	25	7.0	9.0	40.5	250	17,00
4157	EKMUF - 35	35	8.2	11.0	45.5	150	23,00
4158	EKMUF - 50	50	9.5	13.5	53.5	90	32,00
4159	EKMUF - 70	70	11.2	14.5	57.5	65	49,00
4160	EKMUF - 95	95	13.4	17.0	61.5	50	60,00
4161	EKMUF - 120	120	15.0	19.5	74.0	40	80,00
4162	EKMUF - 150	150	16.5	21.0	79.0	25	134,00
4163	EKMUF - 185	185	19.0	24.0	85.0	22	155,00
4164	EKMUF - 240	240	21.0	26.0	94.0	18	230,00

U KLEMENS



Sipariş Kodu	Ürün Kodu	Açıklama	Kutu Adet	Birim Fiyat TL / Adet
4165	JUK 6	6mm U Klemens	150	28,00
4166	JUK 10	10mm U Klemens	125	39,00
4167	JUK 16	16mm U Klemens	100	50,00
4168	JUK 25	25mm U Klemens	100	60,20
4169	JUK 35	35mm U Klemens	75	65,00
4170	JUK 50	50mm U Klemens	50	98,75
4171	JUK 70	70mm U Klemens	40	121,00
4172	JUK 95	95mm U Klemens	25	169,00
4173	JUK 120	120mm U Klemens	20	194,00
4174	JUK 150	150mm U Klemens	15	296,00

MONOFAZE MÜŞTEREK W OTOMAT BARALARI

Sipariş Kodu	Ürün Kodu	Bakır Kalınlığı	Boy	Modül	Amper	Açıklama	Kutu Adet	Birim Fiyat TL / Adet
4201	M - 531	1 mm	53 cm	30 Otomat için	80 A	Monofaze Müşterek W Otomat Bara	50	☎
4202	M - 1061	1 mm	106 cm	60 Otomat için	80 A	Monofaze Müşterek W Otomat Bara	50	☎
4203	M - 5315	1.5 mm	53 cm	30 Otomat için	100 A	Monofaze Müşterek W Otomat Bara	50	☎
4204	M - 10615	1.5 mm	106 cm	60 Otomat için	100 A	Monofaze Müşterek W Otomat Bara	50	☎

TRİFAZE MÜŞTEREK W OTOMAT BARALARI

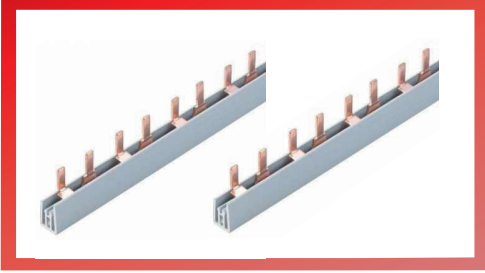

İSTEDİĞİNİZ ÖLÇÜDE KESİM YAPILIR.

Sipariş Kodu	Ürün Kodu	Bakır Kalınlığı	Boy	Modül	Amper	Açıklama	Kutu Adet	Birim Fiyat TL / Adet
4205	T - 221	1 mm	22 cm	4 Grup için	80 A	Trifaze Müşterek W Otomat Bara		☎
4206	T - 331	1 mm	33 cm	6 Grup için	80 A	Trifaze Müşterek W Otomat Bara		☎
4207	T - 441	1 mm	44 cm	8 Grup için	80 A	Trifaze Müşterek W Otomat Bara		☎
4208	T - 531	1 mm	53 cm	10 Grup için	80 A	Trifaze Müşterek W Otomat Bara	25	☎
4209	T - 1061	1 mm	106 cm	20 Grup için	80 A	Trifaze Müşterek W Otomat Bara	25	☎
4210	T - 2215	1.5 mm	22 cm	4 Grup için	100 A	Trifaze Müşterek W Otomat Bara		☎
4211	T - 3315	1.5 mm	33 cm	6 Grup için	100 A	Trifaze Müşterek W Otomat Bara		☎
4212	T - 4415	1.5 mm	44 cm	8 Grup için	100 A	Trifaze Müşterek W Otomat Bara		☎
4213	T - 5315	1.5 mm	53 cm	10 Grup için	100 A	Trifaze Müşterek W Otomat Bara	25	☎
4214	T - 10615	1.5 mm	106 cm	20 Grup için	100 A	Trifaze Müşterek W Otomat Bara	25	☎
4215				Jameson - Kapak		Bara Kapağı	500	☎

MONTAJ RAYLARI

Sipariş Kodu	Ürün Kodu	Açıklama	Uzunluk (m)	Kutu Adet	Birim Fiyat TL / Adet
4175	JW-MR1	1mm Delikli Saç Montaj Rayı	1 m	50	☎
4176	JW-MR2	1mm Delikli Saç Montaj Rayı	2 m	25	☎
4182	JW-MR3	Ray Taşıyıcı Saç		100	☎

NÖTR TOPRAKLAMA BARALAR

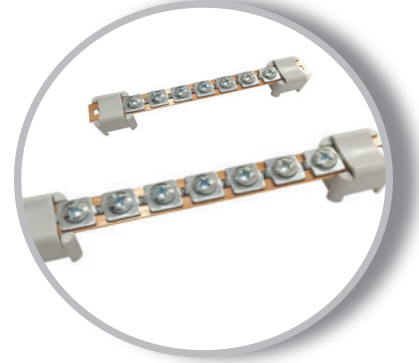

Sipariş Kodu	Ürün Kodu	Bakır Kalınlığı	Uzunluk (m)	Kullanım Yeri	Kutu Adet	Birim Fiyat TL / Adet
4177	JNTB-1.5-31	15mm x 1,5mm	1 mt	31 Vida	50	☎
4178	JNTB-1.5-61	15mm x 1,5mm	1 mt	61 Vida	50	☎
4179	JNTB-2-31	15mm x 2mm	1 mt	31 Vida	50	☎
4180	JNTB-2-61	15mm x 2mm	1 mt	61 Vida	50	☎
4181	Nötr Bara Mesneti	15mm x 2mm	1 mt	31 Vida	10	☎

RAYA MONTAJLI PRİZ

Sipariş Kodu	Ürün Kodu	Açıklama	Kutu Adet	Birim Fiyat TL / Adet
4183	JPP	Raya Montaj (Kapaklı) Pano Prizi (16A/250V)	10	157,00

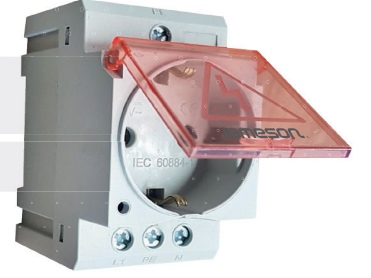

PVC İZOLE BANT

SİPARİŞ KODU	ÜRÜN KODU	ÖLÇÜLER	KOLİ ADET	Birim Fiyat USD / Ad.
5703	İZOLE BANT	0.50 mm x 50 mm x 9.1 m	36	



JKS SERİSİ KAPI SIVIÇLERİ

SİPARİŞ KODU	ÜRÜN KODU	KONTAK	AÇIKLAMA	KUTU ADET	KOLİ ADET	Birim Fiyat TL / Ad.
5808	JKS-10	NO	Açık Kontak Kapı Sivici	50	500	50.00
5809	JKS-01	NC	Kapalı Kontak Kapı Sivici	50	500	55.00

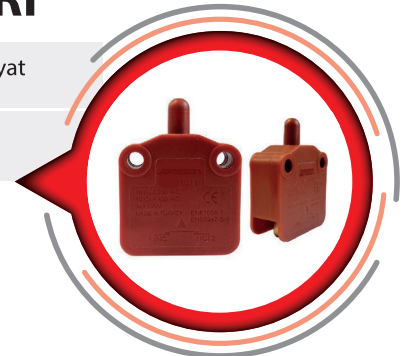

2 KUTUPLU DAĞITICI ÜNİTELER

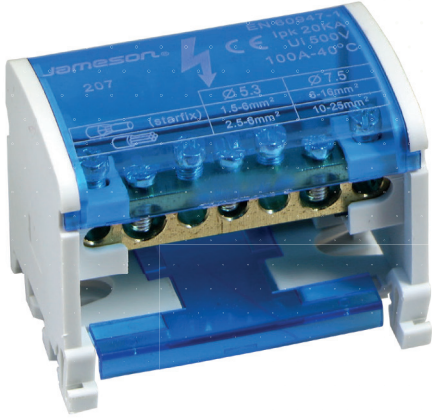

BİRİM FİYAT TL / AD	225,00	
SİPARİŞ KODU	4301	
ÜRÜN KODU	JD-2x7	
AKIM	125 Amper	
KABLO CİNSİ	Tek Damar	Çok Telli
	Giriş	Çıkış
KABLO KESİTİ (mm ²)	1 x 10 - 35 mm ²	1 x 10 - 25 mm ² 5 x 1,5 - 6 mm ²
	1 x 10 - 16 mm ²	1 x 6 - 16 mm ² 5 x 1,5 - 6 mm ²
Ambalaj Adet	Paket	Koli
	1	138

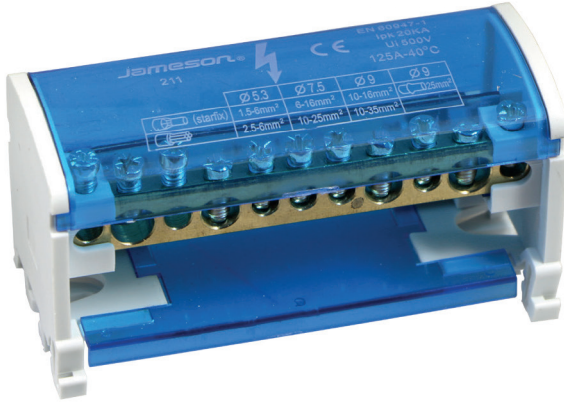

BİRİM FİYAT TL / AD	320,00	
SİPARİŞ KODU	4302	
ÜRÜN KODU	JD-2x11	
AKIM	125 Amper	
KABLO CİNSİ	Tek Damar	Çok Telli
	Giriş	Çıkış
KABLO KESİTİ (mm ²)	2 x 10 - 35 mm ²	2 x 10 - 25 mm ² 7 x 2,5 - 6 mm ²
	2 x 10 - 16 mm ²	2 x 6 - 16 mm ² 7 x 1,5 - 6 mm ²
Ambalaj Adet	Paket	Koli
	1	84

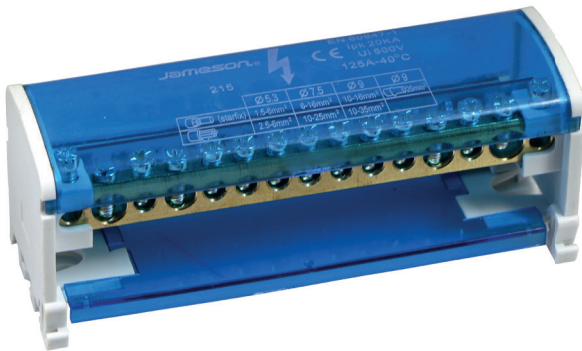

BİRİM FİYAT TL / AD	415,00	
SİPARİŞ KODU	4303	
ÜRÜN KODU	JD-2x15	
AKIM	125 Amper	
KABLO CİNSİ	Tek Damar	Çok Telli
	Giriş	Çıkış
KABLO KESİTİ (mm ²)	2 x 10 - 35 mm ²	2 x 10 - 25 mm ² 11 x 2,5 - 6 mm ²
	2 x 10 - 16 mm ²	2 x 6 - 16 mm ² 11 x 1,5 - 6 mm ²
Ambalaj Adet	Paket	Koli
	1	72

4 KUTUPLU DAĞITICI ÜNİTELER

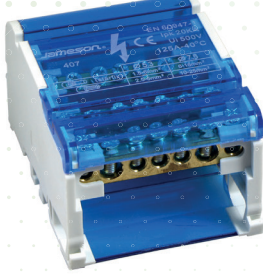

BİRİM FİYAT TL / AD	415,00	
SİPARİŞ KODU	4304	
ÜRÜN KODU	JD-4x7	
AKIM	125 Amper	
KABLO CİNSİ	Tek Damar	Çok Telli
	Giriş	Çıkış
KABLO KESİTİ (mm ²)	1 x 10 - 35 mm ²	1 x 10 - 25 mm ² 5 x 1,5 - 6 mm ²
	1 x 10 - 16 mm ²	1 x 6 - 16 mm ² 5 x 1,5 - 6 mm ²
Ambalaj Adet	Paket	Koli
	1	74

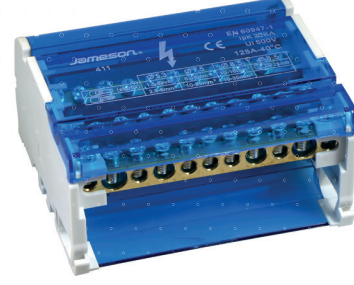

BİRİM FİYAT TL / AD	620,00	
SİPARİŞ KODU	4305	
ÜRÜN KODU	JD-4x11	
AKIM	125 Amper	
KABLO CİNSİ	Tek Damar	Çok Telli
	Giriş	Çıkış
KABLO KESİTİ (mm ²)	2 x 10 - 35 mm ²	2 x 10 - 25 mm ² 7 x 2,5 - 6 mm ²
	2 x 10 - 16 mm ²	2 x 6 - 16 mm ² 7 x 1,5 - 6 mm ²
Ambalaj Adet	Paket	Koli
	1	50

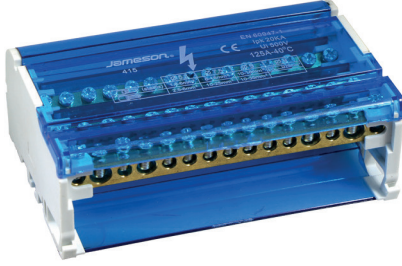

BİRİM FİYAT TL / AD	770,00	
SİPARİŞ KODU	4306	
ÜRÜN KODU	JD-4x15	
AKIM	125 Amper	
KABLO CİNSİ	Tek Damar	Çok Telli
	Giriş	Çıkış
KABLO KESİTİ (mm ²)	2 x 10 - 35 mm ²	2 x 10 - 25 mm ² 11 x 1,5 - 6 mm ²
	2 x 10 - 16 mm ²	2 x 6 - 16 mm ² 11 x 1,5 - 6 mm ²
Ambalaj Adet	Paket	Koli
	1	40

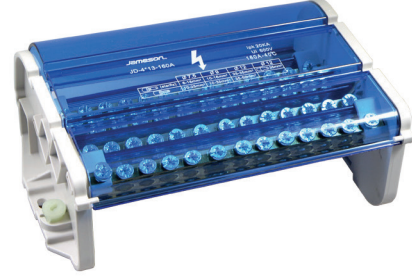

BİRİM FİYAT TL / AD	1,850,00	
SİPARİŞ KODU	4307	
ÜRÜN KODU	JD-4x12/160A	
AKIM	160 Amper	
KABLO CİNSİ	Tek Damar	Çok Telli
	Giriş	Çıkış
KABLO KESİTİ (mm ²)	1 x 10 - 50 mm ²	3 x 10 - 25 mm ² 8 x 1,5 - 6 mm ²
	1 x 10 - 50 mm ²	3 x 6 - 16 mm ² 8 x 1,5 - 6 mm ²
Ambalaj Adet	Paket	Koli
	1	18

TEK KUTUPLU DAĞITICI ÜNİTELER

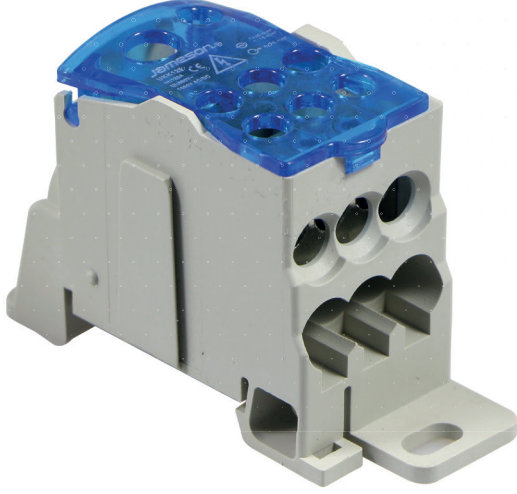

BİRİM FİYAT TL / AD	190,00	
SİPARİŞ KODU	4308	
ÜRÜN KODU	JD-80A	
AKIM	80 Amper	
KABLO CİNSİ	Tek Damar	Çok Telli
KABLO KESİTİ (mm ²)	Giriş	Çıkış
	1 x 10 - 16 mm ²	4 x 2,5 - 6 mm ² 2 x 2,5 - 16 mm ²
Ambalaj Adet	Paket	Koli
	5	100



BİRİM FİYAT TL / AD	390,00	
SİPARİŞ KODU	4309	
ÜRÜN KODU	JD-125A	
AKIM	125 Amper	
KABLO CİNSİ	Tek Damar	Çok Telli
KABLO KESİTİ (mm ²)	Giriş	Çıkış
	1 x 10 - 35 mm ²	6 x 2,5 - 16 mm ² Köprü 1 x 6 - 16 mm ²
Ambalaj Adet	Paket	Koli
	5	75



BİRİM FİYAT TL / AD	395,00	
SİPARİŞ KODU	4310	
ÜRÜN KODU	JD-160A	
AKIM	160 Amper	
KABLO CİNSİ	Tek Damar	Çok Telli
KABLO KESİTİ (mm ²)	Giriş	Çıkış
	1 x 10 - 70 mm ²	6 x 2,5 - 16 mm ² Köprü 2 x 2,5 - 16 mm ²
Ambalaj Adet	Paket	Koli
	5	50

TEK KUTUPLU DAĞITICI ÜNİTELER



BİRİM FİYAT TL / AD	1,140,00	
SİPARİŞ KODU	4311	
ÜRÜN KODU	JD-250A	
AKIM	250 Amper	
KABLO CİNSİ	Tek Damar	Çok Tellî
	Giriş	Çıkış
KABLO KESİTİ (mm ²)	1 x 35 - 120 mm ²	4 x 2,5 - 10 mm ² 5 x 2,5 - 16 mm ² 2 x 6 - 35 mm ²
	Ambalaj Adet	Paket
	3	30



BİRİM FİYAT TL / AD	1,200,00	
SİPARİŞ KODU	4312	
ÜRÜN KODU	JD-400A	
AKIM	400 Amper	
KABLO CİNSİ	Tek Damar	Çok Tellî
	Giriş	Çıkış
KABLO KESİTİ (mm ²)	1 x 95 - 185 mm ²	4 x 2,5 - 10 mm ² 5 x 2,5 - 16 mm ² 2 x 6 - 35 mm ²
	Ambalaj Adet	Paket
	3	20



BİRİM FİYAT TL / AD	1,300,00	
SİPARİŞ KODU	4313	
ÜRÜN KODU	JD-500A	
AKIM	500 Amper	
KABLO CİNSİ	Tek Damar	Çok Tellî
	Giriş	Çıkış
KABLO KESİTİ (mm ²)	8 x 24 mm ²	4 x 2,5 - 10 mm ² 5 x 2,5 - 16 mm ² 2 x 6 - 35 mm ²
	Ambalaj Adet	Paket
	3	20

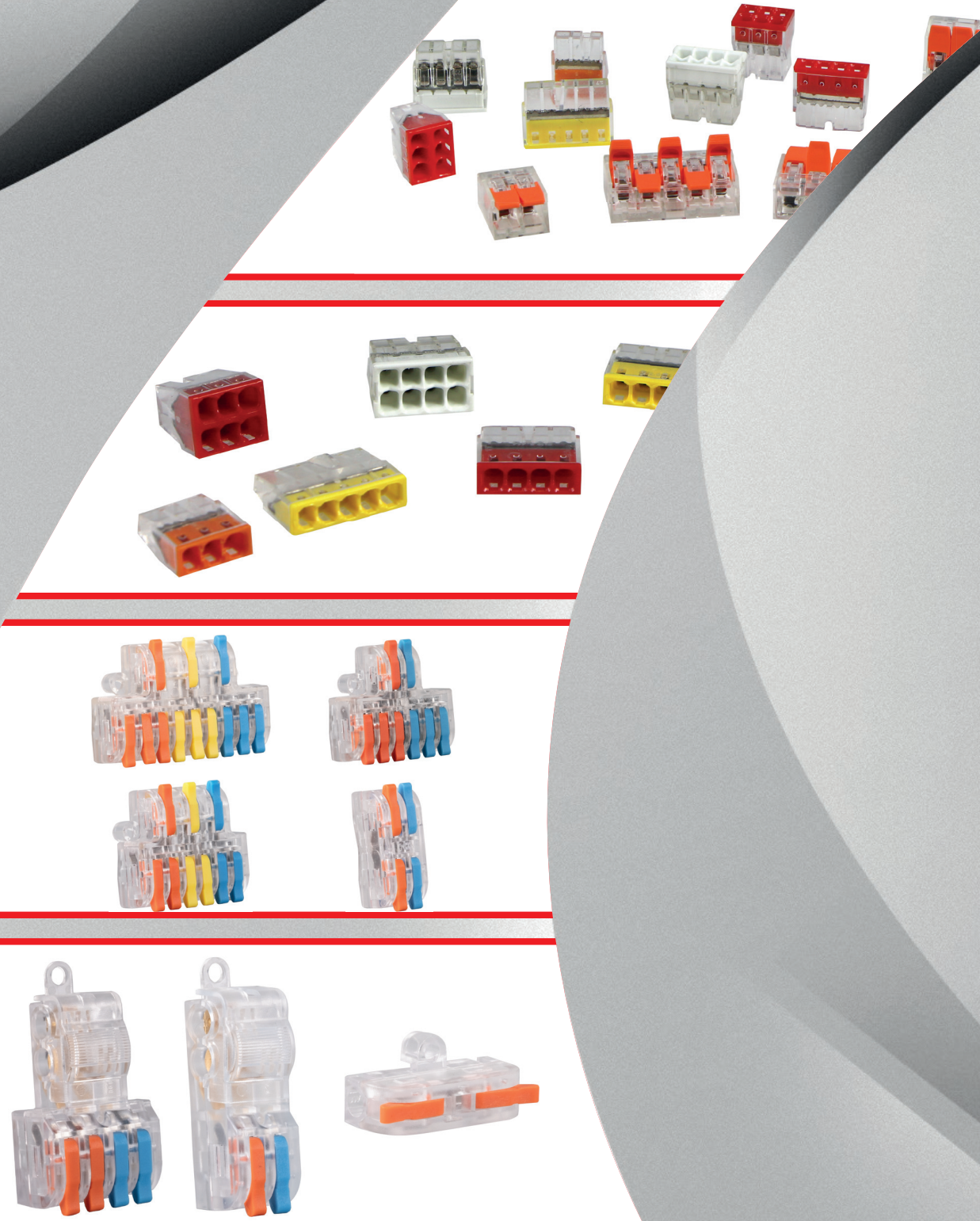





JAMESON®

ÇOK AMAÇLI KLEMENSLER

www.kivilcimelektrik.com.tr

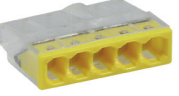
GEÇMELİ BUAT KLEMENS

Sipariş Kodu	Ürün Kodu	Renk	Kablo Kesiti	Ebatlar (mm)			Ambalaj Adet		Birim Fiyat TL / Adet	
				En	Boy	Yükseklik	Paket	Koli		
4401	JW 2.5-2	Beyaz	0.50 - 2.5 mm ²	9.8	16.4	5.8	200	10.000	4,500	
4402	JW 2.5-3	Turuncu	0.50 - 2.5 mm ²	13.9	16.4	5.8	200	10.000	4,700	
4403	JW 2,5 4	Kırmızı	0.50 - 2.5 mm ²	17.9	16.4	5.8	100	5000	5,400	
4404	JW 2,5-5	Sarı	0.50 - 2.5 mm ²	21.9	16.4	5.8	100	5000	6,300	
4405	JW 2,5-6	Kırmızı	0.50 - 2.5 mm ²	13.8	16.4	11.25	100	5000	7,900	
4406	JW 2,5-8	Gri	0.50 - 2.5 mm ²	17.8	16.4	11.25	100	5000	9,000	

ÇOK AMAÇLI KLEMENS

Sipariş Kodu	Ürün Kodu	Kablo Kesiti	Açıklama	Ambalaj Adet		Birim Fiyat TL / Adet	
				Paket	Koli		
4407	JW-412	0.14 - 4.0 mm ²	2 İletken Bağlantılı	100	5000	8,000	
4408	JW-413	0.14 - 4.0 mm ²	3 İletken Bağlantılı	100	5000	10,700	
4409	JW-414	0.14 - 4.0 mm ²	4 İletken Bağlantılı	50	2500	13,000	
4410	JW-415	0.14 - 4.0 mm ²	5 İletken Bağlantılı	50	2500	15,600	

ÇALIŞMA SICAKLIĞI: -40 °C «» 100 °C **NOMİNAL AKIM:** 32A **NOMİNAL GERİLİM:** 450V

DAĞITICILI BUAT KLEMENS

YENİ
ÜRÜN

Sipariş Kodu	Ürün Kodu	Renk	Kablo Kesiti	Ebatlar (mm)			Ambalaj Adet		Birim Fiyat TL / Adet	
				En	Boy	Yükseklik	Paket	Koli		
7745	JCT 2-2	Beyaz	0.50 - 2.5 mm ²	13.6	40.3	14.5	50	2000	12,80	
7746	JCT 3-3	Beyaz	0.50 - 2.5 mm ²	18.6	40.3	14.5	50	2000	17,10	
7747	JDK T22	Beyaz	0.50 - 2.5 mm ²	13.0	43.0	13.4	50	2000	37,35	
7748	JDK T42	Beyaz	0.50 - 2.5 mm ²	23-13	31.5	13.5	50	2000	49,00	
7749	JDK - 42	Beyaz	0.50 - 2.5 mm ²	23-13	31.5	13.5	50	2000	21,50	
7750	JDK - 62	Beyaz	0.50 - 2.5 mm ²	33-13	31.5	13.5	40	2000	35,50	
7751	JDK - 63	Beyaz	0.50 - 2.5 mm ²	33-13	31.5	13.5	30	1000	36,80	
7751	JDK - 93	Beyaz	0.50 - 2.5 mm ²	48-28	31.5	3.5	30	1000	46,00	
7752	JRJ45- CAT6	Beyaz					100	1000	2,98	

NOMİNAL AKIM: 32A NOMİNAL GERİLİM: 450V

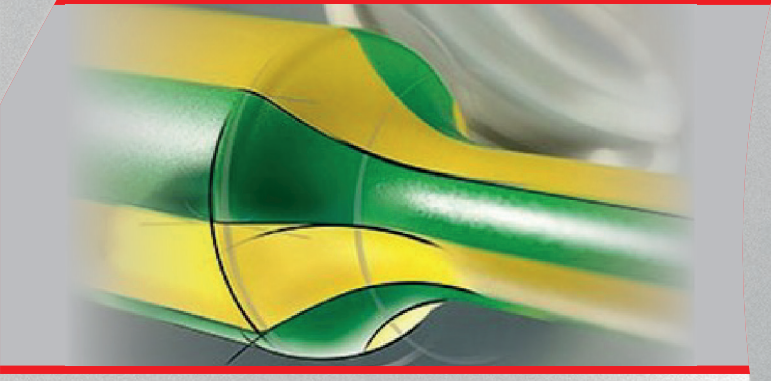

JAMESON®

**MAKARON
ÇEŞİTLERİ ve KABLO
TOPLAMA ÇORAPLARI**

www.kivilcimelektrik.com.tr

ISI İLE DARALAN SİYAH MAKARONLAR

Sipariş Kodu	Ölçü		Daralmadan Önce (mm)		Daralmadan Sonra (mm)		Makara / Mt.	Koli Miktarı	Birim Fiyatı USD / Mt.
	Inch	mm	İç Çap	Cidar Kalınlığı	İç Çap	Cidar Kalınlığı			
5015	—	1	2.0 ± 0.3	0.16 ± 0.05	0.70	0.30 ± 0.05	200	3200	0.085
5016	—	1.5	2.0 ± 0.3	0.16 ± 0.05	0.80	0.30 ± 0.05	200	2400	0.097
5017	—	2	2.5 ± 0.3	0.16 ± 0.05	1.00	0.35 ± 0.05	200	3000	0.115
5018	3/32	2.4	3.0 ± 0.3	0.16 ± 0.05	1.50	0.35 ± 0.05	200	3000	0.115
5019	—	2.5	3.0 ± 0.3	0.16 ± 0.05	1.25	0.38 ± 0.05	200	2600	0.15
5020	—	3	3.4 ± 0.4	0.20 ± 0.05	1.50	0.38 ± 0.05	200	2200	0.16
5021	1/8	3.2	3.5 ± 0.4	0.20 ± 0.05	1.75	0.40 ± 0.05	200	2200	0.16
5022	—	3.5	4.0 ± 0.4	0.20 ± 0.05	1.75	0.40 ± 0.05	200	1800	0.17
5023	—	4	4.5 ± 0.4	0.20 ± 0.05	2.00	0.45 ± 0.05	200	1400	0.20
5024	—	4.5	4.8 ± 0.4	0.20 ± 0.05	2.00	0.47 ± 0.08	100	1000	0.23
5025	3/16	4.8	5.2 ± 0.4	0.20 ± 0.05	2.60	0.47 ± 0.08	100	1000	0.23
5026	—	5	5.5 ± 0.4	0.20 ± 0.05	2.50	0.55 ± 0.08	100	900	0.25
5027	—	6	6.5 ± 0.4	0.22 ± 0.05	3.00	0.55 ± 0.05	100	700	0.29
5028	1/4	6.4	7.0 ± 0.4	0.28 ± 0.05	3.50	0.55 ± 0.08	100	700	0.29
5029	—	7	7.5 ± 0.4	0.28 ± 0.05	3.50	0.60 ± 0.08	100	500	0.35
5030	—	8	8.5 ± 0.4	0.30 ± 0.08	4.00	0.60 ± 0.08	100	1300	0.35
5031	3/8	9.5	10.0 ± 0.5	0.30 ± 0.08	5.00	0.60 ± 0.08	100	1200	0.35
5032	—	10	10.0 ± 0.5	0.30 ± 0.08	5.00	0.60 ± 0.08	100	1100	0.39
5033	1/2	12.7	13.0 ± 0.5	0.33 ± 0.10	6.50	0.65 ± 0.08	100	1000	0.45
5034	—	13	13.5 ± 0.5	0.33 ± 0.10	6.50	0.65 ± 0.08	100	900	0.48
5035	—	14	14.5 ± 0.5	0.33 ± 0.10	7.00	0.70 ± 0.08	100	900	0.56
5036	4/5	16	16.5 ± 0.6	0.35 ± 0.12	8.00	0.75 ± 0.08	100	800	0.75
5037	—	18	19.0 ± 0.6	0.40 ± 0.15	9.00	0.80 ± 0.15	100	700	0.98
5038	3/4	19.1	20.5 ± 0.6	0.40 ± 0.15	10.00	0.80 ± 0.15	100	700	0.98
5039	—	20	20.5 ± 0.6	0.40 ± 0.15	10.00	0.80 ± 0.15	100	600	1.25
5040	—	22	22.5 ± 0.7	0.45 ± 0.15	12.00	0.95 ± 0.15	100	600	1.55
5041	1	25.4	25.6 ± 0.7	0.45 ± 0.15	12.00	0.95 ± 0.15	50	300	1.65
5042	—	30	31.5 ± 0.7	0.50 ± 0.15	15.00	0.95 ± 0.15	50	250	2.15
5043	1 — 1/4	32	33.0 ± 0.7	0.50 ± 0.15	16.50	0.95 ± 0.15	50	250	2.15
5044	—	35	38.0 ± 0.7	0.50 ± 0.15	16.00	1.00 ± 0.15	50	200	2.70
5045	1 — 1/2	38	40.0 ± 0.7	0.50 ± 0.15	20.00	1.00 ± 0.15	50	200	3.00
5046	—	40	40.5 ± 0.7	0.50 ± 0.15	20.00	1.00 ± 0.15	50	200	3.00
5047	2	51	52.5 ± 0.7	0.50 ± 0.15	25.00	1.00 ± 0.15	25	125	3.80
5048	—	60	60.5 ± 0.8	0.52 ± 0.15	30.00	1.00 ± 0.16	25	100	5.10
5049	—	70	70.5 ± 1.0	0.55 ± 0.15	40.00	1.10 ± 0.18	25	75	6.80
5050	—	80	82.0 ± 1.0	0.55 ± 0.15	40.00	1.10 ± 0.18	25	75	7.50
5051	—	90	90.0 ± 1.0	0.55 ± 0.15	45.00	1.10 ± 0.18	25	50	8.50
5052	4	102	105.0 ± 1.0	0.55 ± 0.15	51.00	1.10 ± 0.18	25	50	9.50
5053	—	120	120.0 ± 1.0	0.55 ± 0.15	60.00	1.10 ± 0.18	25	50	13.00
5054	—	150	150.0 ± 1.0	0.55 ± 0.15	76.00	1.10 ± 0.18	25	50	19.00
5055	—	180	180.0 ± 1.0	0.55 ± 0.15	90.00	1.10 ± 0.18	25	25	27.00

ÇALIŞMA SICAKLIĞI: -55 °C «» +125 °C **MALZEME:** Polyolefin **Daralma Oranı:** 2/1 **Yanmazlık:** Kendi kendine söner

ISI İLE DARALAN RENKLİ MAKARONLAR

ŞEFFAF - BEYAZ - KIRMIZI - MAVİ - SARI - YEŞİL - GRİ

TEKNİK ÖZELLİKLER

Malzeme : Polyolefin

Daralma Oranı : 2/1

Yanmazlık : Kendi kendine söner

Çalışma Sıcaklığı : -55°C -- +125°C



Ölçü		Sipariş Kodu							Makara / Mt.	Koli Miktarı	Fiyat USD / Mt.
Inch	mm	ŞEFFAF	BEYAZ	KIRMIZI	MAVİ	SARI	YEŞİL	GRİ			
—	1.5	5101	5117	5138	5154	5175	5195	5211	200	3.200	0.11
—	2.5	5102	5118	5139	5155	5305	5196	5212	200	2.600	0.17
1/8	3.2	5103	5119	5140	5156	5176	5197	5213	200	2.200	0.20
—	3.5	—	5120	—	5157	5177	—	—	200	1.800	0.21
Yassı	3.5	—	5121	—	5158	5178	—	—	100	1.600	0.21
3/16	4.8	5104	5122	5141	5159	5179	5198	5214	100	1.000	0.27
Yassı	4.8	—	5123	—	5160	5180	—	—	100	1.500	0.27
1/4	6.4	5105	5124	5142	5161	5181	5199	5215	100	700	0.33
Yassı	6.4	—	5125	—	5162	5182	—	—	100	1.500	0.33
Yassı	7	—	5126	—	5163	5183	—	—	100	1.400	0.33
3/8	9.5	5106	5127	5143	5164	5184	5200	5216	100	1.200	0.39
—	13	5107	5128	5144	5165	5185	5201	5217	100	900	0.55
4/5	16	5108	5129	5145	5166	5186	5202	5218	100	800	0.85
—	20	5109	5130	5146	5167	5187	5203	5219	100	600	1.50
1	25.4	5110	5131	5147	5168	5188	5204	5220	50	300	1.90
1 - 1/4	32	5111	5132	5148	5169	5189	5205	5221	50	250	2.40
1 - 1/2	38	5112	5133	5149	5170	5190	5206	5222	50	200	3.60
2	51	5113	5134	5150	5171	5191	5207	5223	25	125	4.20
—	60	5114	5135	5151	5172	5192	5208	5224	25	100	5.80
—	80	5115	5136	5152	5173	5193	5209	5225	25	75	8.00
4	102	5116	5137	5153	5174	5194	5210	5226	25	50	11.00

ISI İLE DARALAN RENKLİ MAKARONLAR

KAHVERENGİ- TURUNCU - MOR

TEKNİK ÖZELLİKLER

Malzeme : Polyolefin

Daralma Oranı : 2/1

Yanmazlık : Kendi kendine söner

Çalışma Sıcaklığı : -55°C -- +125°C



Ölçü		Sipariş Kodu			Makara / Mt.	Koli Miktarı	Fiyat USD / Mt.
Inch	mm	KAHVERENGİ	TURUNCU	MOR			
—	1.5	5227	5243	5259	200	3.200	0.12
—	2.5	5228	5244	5260	200	2.600	0.18
1/8	3.2	5229	5245	5261	200	2.200	0.22
3/16	4.8	5230	5246	5262	100	1.000	0.29
1/4	6.4	5231	5247	5263	100	700	0.38
3/8	9.5	5232	5248	5264	100	1.200	0.44
—	13	5233	5249	5265	100	900	0.60
4/5	16	5234	5250	5266	100	800	1.05
—	20	5235	5251	5267	100	600	1.55
1	25.4	5236	5252	5268	50	300	2.10
1 - 1/4	32	5237	5253	5269	50	250	2.80
1 - 1/2	38	5238	5254	5270	50	200	4.10
2	51	5239	5255	5271	25	125	4.90
—	60	5240	5256	5272	25	100	7.50
—	80	5241	5257	5273	25	75	9.00
4	102	5242	5258	5274	25	50	13.50

ISI İLE DARALAN MAKARONLAR

SARI YEŞİL

TEKNİK ÖZELLİKLER

Malzeme : Polyolefin

Daralma Oranı : 2/1

Yanmazlık : Kendi kendine söner

Çalışma Sıcaklığı : -55°C -- +125°C



Sipariş Kodu	Ölçü		Daralmadan Önce (mm)		Daralmadan Sonra (mm)		Makara / Mt.	Koli Miktarı	Fiyat USD / Mt.
	Inch	mm	İç Çap	Cidar Kalınlığı	İç Çap	Cidar Kalınlığı			
5275	3/32	2.4	3.0 ± 0.3	0.16 ± 0.05	1.50	0.35 ± 0.05	200	3.000	0.42
5276	1/8	3.2	3.5 ± 0.4	0.20 ± 0.05	1.75	0.40 ± 0.05	200	2.200	0.43
5277	3/16	4.8	5.2 ± 0.4	0.20 ± 0.05	2.60	0.47 ± 0.08	100	1.000	0.44
5278	1/4	6.4	7.0 ± 0.4	0.28 ± 0.05	3.50	0.55 ± 0.08	100	700	0.50
5279	3/8	9.5	10.0 ± 0.5	0.30 ± 0.08	5.00	0.65 ± 0.08	100	1.200	0.68
5280	—	13	13.5 ± 0.5	0.33 ± 0.10	6.50	0.75 ± 0.08	100	900	1.00
5281	4/5	16	16.5 ± 0.6	0.35 ± 0.12	8.00	0.80 ± 0.15	100	800	1.45
5282	—	20	20.5 ± 0.6	0.40 ± 0.15	10.00	0.95 ± 0.15	100	600	1.90
5283	1	25.4	25.6 ± 0.7	0.45 ± 0.15	12.00	0.95 ± 0.15	50	300	2.75
5284	1 - 1/4	32	33.0 ± 0.7	0.50 ± 0.15	16.50	1.00 ± 0.15	50	250	3.70
5285	1 - 1/2	38	40.0 ± 0.7	0.50 ± 0.15	20.00	1.00 ± 0.15	50	200	5.00
5286	2	51	52.5 ± 0.7	0.50 ± 0.15	25.00	1.00 ± 0.15	50	125	7.00
5287	—	60	60.5 ± 0.8	0.52 ± 0.15	30.00	1.00 ± 0.16	25	100	10.00
5288	—	80	82.5 ± 1.0	0.55 ± 0.15	40.00	1.00 ± 0.18	25	75	15.00
5289	4	102	105.0 ± 1.0	0.55 ± 0.15	51.00	1.00 ± 0.18	25	50	23.00

İÇİ YAPIŞKANLI BORU TİPİ MAKARONLAR

Sipariş Kodu	Ölçü	Daralmadan Önce (mm)		Daralmadan Sonra (mm)		Makara / Mt.	Koli Miktarı	Fiyat USD / Mt.
		İç Çap	Azami İç Çap	Anma Cidar Kalınlığı	Anma Yapışkanlığı			
5290	3/1	3	1.00	1.10 ± 0.10	0.50	200	1.800	0,65
5291	4.8/1.5	4.8	1.50	1.20 ± 0.10	0.50	100	900	0,80
5292	6.2	6	2.00	1.30 ± 0.10	0.50	100	600	1.20
5293	9/3	9	3.00	1.70 ± 0.15	0.60	50	300	1.60
5294	12/4	12	4.00	2.00 ± 0.20	0.80	1.20 Boy	250	2,30
5295	16/5	16	5.00	2.20 ± 0.20	0.80	1.20 Boy	250	3.20
5296	19/6	19	6.00	2.30 ± 0.20	0.80	1.20 Boy	150	4.50
5297	28/9	28	9.00	2.40 ± 0.20	1.05	1.20 Boy	110	5.10
5298	33/10	33	10.00	2.50 ± 0.20	1.05	1.20 Boy	100	5.80
5299	40/12	40	12.00	2.50 ± 0.20	1.05	1.20 Boy	90	6.40
5300	44/14	44	14.00	2.50 ± 0.20	1.05	1.20 Boy	60	7.10
5301	52/18	52	18.00	2.50 ± 0.20	1.05	1.20 Boy	60	8.00
5302	70/25	70	25.00	3.00 ± 0.30	1.35	1.20 Boy	32	11.30
5303	90/30	90	30.00	3.00 ± 0.30	1.35	1.20 Boy	24	16.00
5304	125/40	125	40.00	3.00 ± 0.30	1.35	1.20 Boy	20	20.00

MAKARONLAR TEKNİK ÖZELLİKLER

Malzeme : Polyolefin

Daralma Oranı : 3/1

Yanmazlık : Kendi kendine söner

Çalışma Sıcaklığı : -55°C -- +125°C

İÇİ
YAPIŞKANLI
BORU
TİPİ



H CLASS CAM ELYAF SİLİKON İZOLELİ MAKARONLAR

Sipariş Kodu	Ölçü	Renk	Makara / Mt.	Koli Miktarı	Fiyat USD / Mt.
5401	1 mm	Kırmızı	200	2.600	0.23
5402	2 mm	Kırmızı	200	2.600	0.25
5403	3 mm	Kırmızı	100	2.000	0.38
5404	4 mm	Kırmızı	100	1.500	0.52
5405	5 mm	Kırmızı	100	1.000	0.62
5406	6 mm	Kırmızı	100	1.000	0.77
5407	7 mm	Kırmızı	100	1.000	0.88
5408	8 mm	Kırmızı	50	1.000	1.00
5409	10 mm	Kırmızı	50	600	1.37
5410	12 mm	Kırmızı	50	500	1.70
5411	14 mm	Kırmızı	50	500	2.05
5412	16 mm	Kırmızı	25	400	2.70
5413	18 mm	Kırmızı	25	400	3.50
5414	20 mm	Kırmızı	25	350	4.50
5415	25 mm	Kırmızı	25	150	8.50
5416	30 mm	Kırmızı	25	150	12.50
5417	35 mm	Kırmızı	25	150	15.00

TEKNİK ÖZELLİKLER

MALZEME: Silikon İzoleli Cam Elyaf Örgü Makaron

ÇALIŞMA SICAKLIĞI: -60 °C «» +250 °C



PVC İZOLELİ CAM ELYAF MAKARONLAR

Sipariş Kodu	Ölçü	Renk	Makara / Mt.	Koli Miktarı	Fiyat USD / Mt.
5501	1 mm	Beyaz Üzeri Çizgili	200	2.400	0.15
5502	2 mm	Beyaz Üzeri Çizgili	200	2.400	0.19
5503	3 mm	Beyaz Üzeri Çizgili	100	2.400	0.24
5504	4 mm	Beyaz Üzeri Çizgili	100	2.000	0.33
5505	5 mm	Beyaz Üzeri Çizgili	100	1.400	0.40
5506	6 mm	Beyaz Üzeri Çizgili	100	1.300	0.45
5507	7 mm	Beyaz Üzeri Çizgili	100	1.200	0.50
5508	8 mm	Beyaz Üzeri Çizgili	100	1.000	0.68
5509	10 mm	Beyaz Üzeri Çizgili	50	1.000	0.85
5510	12 mm	Beyaz Üzeri Çizgili	50	1.000	0.95
5511	14 mm	Beyaz Üzeri Çizgili	50	650	1.35
5512	16 mm	Beyaz Üzeri Çizgili	50	600	1.42
5513	18 mm	Beyaz Üzeri Çizgili	50	400	1.50
5514	20 mm	Beyaz Üzeri Çizgili	25	400	2.97

TEKNİK ÖZELLİKLER

MALZEME: PVC İzoleli Cam Elyaf Makaron

ÇALIŞMA SICAKLIĞI: -20 °C «» +130 °C



KABLO TOPLAMA ÇORABI

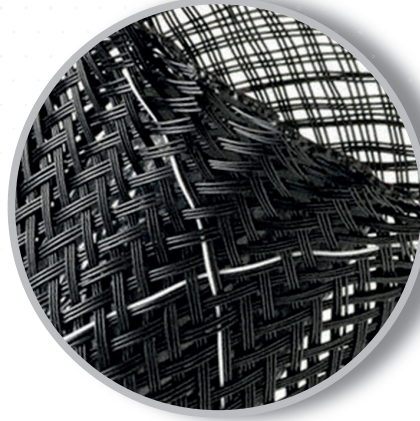
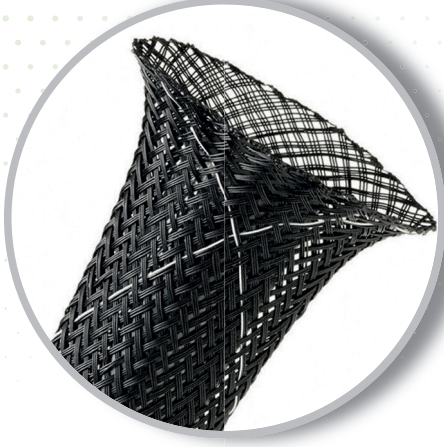

TEKNİK ÖZELLİKLER

MALZEME: Pet (Polyester)

ÇALIŞMA SICAKLIĞI: -50 °C «» +150 °C

DAYANIM ÜST NOKTASI: 220 °C

ERİME NOKTASI: +250 °C

Sipariş Kodu	Ölçü	Renk	Esneleme Aralığı		Makara / Mt.	Fiyat USD / Mt.
			Min (mm)	Max (mm)		
5601	3 mm	Siyah	1	6	100	0.24
5602	6 mm	Siyah	3	9	100	0.29
5603	8 mm	Siyah	5	16	100	0.30
5604	10 mm	Siyah	7	19	100	0.36
5605	12 mm	Siyah	8	24	100	0.43
5606	15 mm	Siyah	10	27	100	0.48
5607	20 mm	Siyah	14	30	100	0.56
5608	25 mm	Siyah	18	35	100	0.72
5609	30 mm	Siyah	20	50	50	0.87
5610	40 mm	Siyah	30	60	50	1.14
5611	50 mm	Siyah	40	80	25	1.40



YENİ
ÜRÜN



YENİ
ÜRÜN



YENİ
ÜRÜN



JAMESON®

MEKANİK VE HİDROLİK EL ALETLERİ

www.kivilcimelektrik.com.tr

YÜKSÜK SIKMA PENSELERİ / MEKANİK EL ALETLERİ

Sipariş Kodu: 6001

T-007

0.5-10 mm² Yüksük Sıkma Pensesi



135.00
USD

Sipariş Kodu: 6002

AN-03C

0.5-6 mm² Yüksük Sıkma Pensesi



65,00
USD

Sipariş Kodu: 6003

AN-004

0.5-10 mm² İzolesiz Kablo Ucu Sıkma Pensesi



65,00
USD

Sipariş Kodu: 6004

AN-04WFL

0.5-6 mm² Yüksük Sıkma Pensesi



70,00
USD

Sipariş Kodu: 6005

AN-006

0.5-6 mm² İzoleli Kablo Ucu Sıkma Pensesi



72,00
USD

Sipariş Kodu: 6006

AN-10

1.5-10 mm² İzolesiz Kablo Ucu Sıkma Pensesi



65.00
USD

Sipariş Kodu: 6007

AP-006

0.5-6 mm² İzoleli Kablo Ucu Sıkma Pensesi



72,00
USD

Sipariş Kodu: 6008

AN-16WF

1-16 mm² İzoleli Kablo Ucu Sıkma Pensesi



65,00
USD

Sipariş Kodu: 6009

AN-35WF

10-35 mm² İzoleli Kablo Ucu Sıkma Pensesi



68,00
USD

Sipariş Kodu: 6010

HSC8 6-4A

0.25-6 mm² İzoleli Kablo Ucu Sıkma Pensesi



89,00
USD

Sipariş Kodu: 6011

HSC8 6-6

0.25-6 mm² İzoleli Kablo Ucu Sıkma Pensesi



105,00
USD

Sipariş Kodu: 6012

HSC8 16-4

0,08-16 mm² İzoleli Kablo Ucu Sıkma Pensesi



115,00
USD

KABLO SIYIRICILARI / MEKANİK EL ALETLERİ

Sipariş Kodu: 6013

HS-2204

Kablo Siyirici

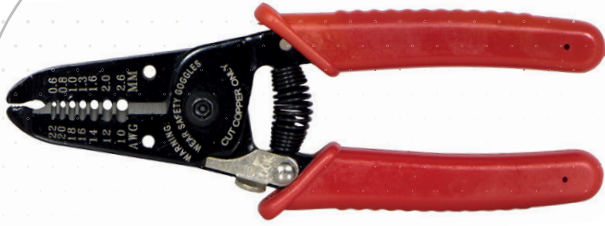

25.00
USD

Sipariş Kodu: 6014

ST700D

Kablo Siyirici



33.00
USD

Sipariş Kodu: 6015

HY-369A

0.5-2 mm² Tekli Kablo Sıyırma Pensesi



34,00
USD

Sipariş Kodu: 6016

G-2096C

6/8 PIN Konnektör Sıkma Pensesi

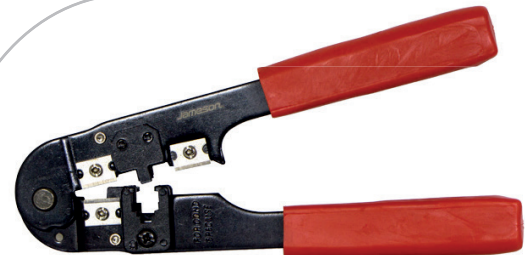

35,00
USD



Sipariş Kodu: 6017

JEA-ST766K

Kablo Siyirici ve Yüzük Sıkma Pensesi



59,00
USD

Sipariş Kodu: 6018

JEA-CT468ST

4-6-8 (Testli) Konnektör Sıkma Pensesi

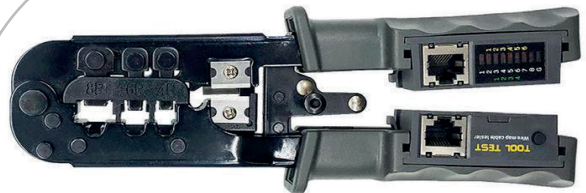

YENİ
ÜRÜN

75,00
USD



Sipariş Kodu: 6019

AN-103

1.0-6 mm² Kablo Kapama Pensesi



65,00
USD

Sipariş Kodu: 6029

LK-22A

22 - 160 mm² Kablo Kesme Makası



32,00
USD

Sipariş Kodu: 6028

LK-38A

38- 210 mm² Kablo Kesme Makası



36,00
USD

Sipariş Kodu: 6027

LK-60A

60 - 230 mm² Kablo Kesme Makası



42,00
USD

Sipariş Kodu:7755

PT3141

Telefon Krone Kep Kep Pense



7,50
USD

Sipariş Kodu:7756

JEA-CT315

6-8 PIN Konnektör Sıkma Pensesi

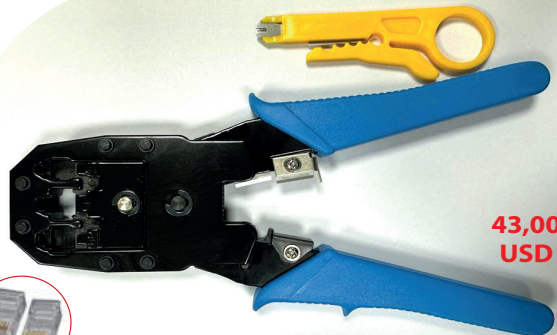

43,00
USD

KABLO KESME MAKASLARI

Sipariş Kodu: 6022

TC- 100

120 mm² Kablo Kesme Makası



74,00
USD

Sipariş Kodu: 6023

TC-250

250 mm² Kablo Kesme Makası



143,00
USD

Sipariş Kodu: 6025

TC-500

630 mm² Kablo Kesme Makası



207,00
USD

Sipariş Kodu: 6029

TCR-325

325 mm² Bakır ve Alüminyum Kablo Kesme Makası



205,00
USD

Sipariş Kodu: 6028

ZC-52A

500 mm² Çok Telli Kablo Kesme Makası



345,00
USD

Sipariş Kodu: 6027

ZC-60A

500 mm² Bakır ve Alüminyum Kablo Kesme Makası



240,00
USD

KABLO PABUCU MEKANİK VE HİDROLİK SIKMA PENSELERİ

Sipariş Kodu: 6031

JY-0650

6 - 50 mm² SKP Sıkma Pensesi



90,00
USD

Sipariş Kodu: 6032

JY-06120

0.6 - 120 mm² SKP Sıkma Pensesi



185,00
USD

Sipariş Kodu: 6033

JY-25150

25 - 150 mm² SKP Sıkma Pensesi



190,00
USD

Sipariş Kodu: 6036

YQK-70

10 - 70 mm² Hidrolik SKP Sıkma Pensesi (Çantalı Set)



112,00
USD

Sipariş Kodu: 6035

YQK-300

16 - 300 mm² Hidrolik SKP Sıkma Pensesi (Çantalı Set)



155,00
USD

Sipariş Kodu: 6034

YQK-120

10 - 120 mm² Hidrolik SKP Sıkma Pensesi (Çantalı Set)



145,00
USD

ŞARJLI KABLO SIYIRICI VE SIKMA PENSELERİ

Sipariş Kodu: 6026

JL-1028

10 mm ile 28,4 mm kablo siyirici



1,300,00
USD

Sipariş Kodu: 6024

JEM-400

16 mm- 400 mm² şarjlı sıkma pensesi (çantalı set)



2,900,00
USD

Sipariş Kodu: 6030

JEX-50W

Şarj Edilebilir Pili Yüksek Sıkma Pensesi



1,395,00
USD

Sipariş Kodu: 6040

HD-50L

5.5 - 50 mm² Yüksek Sıkma Pensesi



90,00
USD

Sipariş Kodu: 6039

YQK-400

16 mm kare - 400 mm² hidrolik bi metal sıkma pensesi (çantalı set)



475,00
USD

Sipariş Kodu: 6041

T03C-5D

AN-04WFL Yüksek Sıkma 0.5 - 6 mm
AN-16WF Yüksek Sıkma 6 - 16 mm
AN-006 Kablo Ucu Sıkma 0.5 - 6 mm
AN-03B İzolesiz Terminal Sıkma 1 - 4 mm
AN-004 Kaynaklı Papuç Sıkma 0.5 - 10 mm

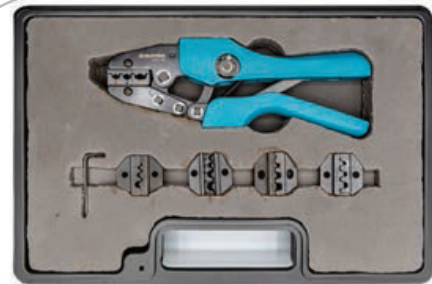

150,00
USD

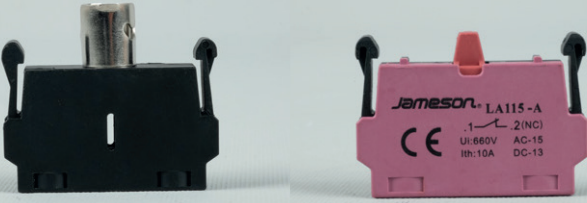

JAMESON[®]

BUTON SERİSİ VE AKSESUARLARI

www.kivilcimelektrik.com.tr

Ø 22mm BUTON SERİSİ YAYLI BUTONLAR

Sipariş Kodu	Ürün Kodu	Kontak	Açıklama	Renk	Kutu Adet	Koli Adet	Fiyat TL. / AD.
7001	A1 - 10	1NO	Yaylı Buton	Yeşil	10	300	84,00
7002	A1 - 01	1NC	Yaylı Buton	Kırmızı	10	300	84,00
7003	A1 - 11	1NO	Yaylı Buton	Sarı	10	300	84,00
7004	A1 - 21	1NO	Yaylı Buton	Mavi	10	300	84,00
7005	A1 - 31	1NO	Yaylı Buton	Beyaz	10	300	84,00
7006	A1 - 41	1NO	Yaylı Buton	Siyah	10	300	84,00



İŞARETLİ YAYLI BUTONLAR

7007	A1 - 10/1	1NO	İşaretlili Yaylı Buton	Yeşil	10	300	99,00
7008	A1 - 01/2	1NC	İşaretlili Yaylı Buton	Kırmızı	10	300	99,00
7009	A1 - 10/3	1NO	İşaretlili Yaylı Buton	Sarı	10	300	99,00
7010	A1 - 10/4	1NO	İşaretlili Yaylı Buton	Mavi	10	300	99,00



İŞIKLI YAYLI BUTONLAR

7011	A1 - 10D	1NO	Işıklı Yaylı Buton 220V AC/DC	Yeşil	10	300	159,00
7012	A1 - 01D	1NC		Kırmızı	10	300	159,00
7013	A1 - 11D	1NO		Sarı	10	300	159,00
7014	A1 - 21D	1NO		Mavi	10	300	159,00
7015	A1 - 31D	1NO		Beyaz	10	300	159,00
7016	A1 - 10D - 110	1NO	Işıklı Yaylı Buton 110V AC/DC	Yeşil	10	300	159,00
7017	A1 - 01D - 110	1NC		Kırmızı	10	300	159,00
7018	A1 - 11D - 110	1NO		Sarı	10	300	159,00
7019	A1 - 21D - 110	1NO		Mavi	10	300	159,00
7020	A1 - 31D - 110	1NO		Beyaz	10	300	159,00
7021	A1 - 10D - 24	1NO	Işıklı Yaylı Buton 24V AC/DC	Yeşil	10	300	159,00
7022	A1 - 01D - 24	1NC		Kırmızı	10	300	159,00
7023	A1 - 11D - 24	1NO		Sarı	10	300	159,00
7024	A1 - 21D - 24	1NO		Mavi	10	300	159,00
7025	A1 - 31D - 24	1NO		Beyaz	10	300	159,00



İKİZ BUTONLAR

7026	A1 - 11R	1NO + 1NC	İkiz Buton	Yeşil - Kırmızı	10	300	161,00
7027	A1 - 11RD	1NO + 1NC	Işıklı İkiz Buton 220 V AC/DC	Yeşil - Kırmızı	10	300	219,00
7028	A1 - 11RD - 110	1NO + 1NC	Işıklı İkiz Buton 110 V AC/DC	Yeşil - Kırmızı	10	300	219,00
7029	A1 - 11RD - 24	1NO + 1NC	Işıklı İkiz Buton 24 V AC/DC	Yeşil - Kırmızı	10	300	219,00



Ø 22mm BUTON SERİSİ KALICI MANDAL BUTONLAR

Sipariş Kodu	Ürün Kodu	Kontakt	Açıklama	Kutu Adet	Koli Adet	Fiyat TL. / AD.
7030	A1 - 10X	1NO	0-1 Mandal Buton 	10	300	97,00
7031	A1 - 20XS	2NO	1-0-2 Mandal Buton 	10	300	131,00



KAYICI MANDAL BUTONLAR

Sipariş Kodu	Ürün Kodu	Kontakt	Açıklama	Kutu Adet	Koli Adet	Fiyat TL. / AD.
7032	A1 - 10X / FU	1NO	0-1 Mandal Buton 	10	300	104,00
7033	A1 - 20XS / FU	2NO	1-0-2 Mandal Buton 	10	300	140,00



ANAHTARLI KALICI & KAYICI BUTONLAR

Sipariş Kodu	Ürün Kodu	Kontakt	Açıklama	Kutu Adet	Koli Adet	Fiyat TL. / AD.
7034	A1 - 10Y	1NO	0-1 Anahtarlı Buton 	10	300	145,00
7035	A1 - 10Y / FU	1NO	0-1 Anahtarlı Buton 	10	300	145,00
7744	A1 - 20YS	2NO	1-0-2 Anahtarlı Buton 	10	300	180,00

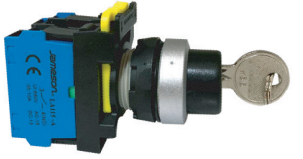

Ø 22mm BUTON SERİSİ KALICI - KAYICI MANDAL BUTON

Sipariş Kodu	Ürün Kodu	Açıklama	Kutu Adet	Koli Adet	Fiyat TL. / AD.
7072	A1-20XS/F	1-0-2 Mandal Buton Sağ Pozisyon Kalıcı Sol Pozisyon Kayıcı	10	300	145,00







JOYSTICK VİNÇ BUTONLAR KALICI VE KAYICI

Sipariş Kodu	Ürün Kodu	Açıklama	Kutu Adet	Koli Adet	Fiyat TL. / AD.
7036	LA155-PA12	2 YÖNLÜ KALICI JOYSTİK	10	300	252,00
7037	LA155-PA14	4 YÖNLÜ KALICI JOYSTİK	10	300	291,00
7073	LA155-PA22	2 YÖNLÜ KAYICI JOYSTİK	10	300	252,00
7074	LA155-PA24	4 YÖNLÜ KAYICI JOYSTİK	10	300	291,00



Ø 22mm BUTON SERİSİ IŞIKLI KALICI MANDAL BUTONLAR

Sipariş Kodu	Ürün Kodu	Kontak	Açıklama	Renk	Kutu Adet	Koli Adet	Fiyat TL. / AD.
7038	A1 - 10XD	1NO		Yeşil	10	300	159,00
7039	A1 - 01XD	1NC		Kırmızı	10	300	159,00
7040	A1 - 11XD	1NO	0-1 Işıklı Mandal Buton 220V AC/DC	Sarı	10	300	159,00
7041	A1 - 21XD	1NO		Mavi	10	300	159,00
7042	A1 - 10XD - 110	1NO		Yeşil	10	300	159,00
7043	A1 - 01XD - 110	1NC		Kırmızı	10	300	159,00
7044	A1 - 11XD - 110	1NO	0-1 Işıklı Mandal Buton 110V AC/DC	Sarı	10	300	159,00
7046	A1 - 21XD - 110	1NO		Mavi	10	300	159,00
7047	A1 - 10XD - 24	1NO		Yeşil	10	300	159,00
7048	A1 - 01XD - 24	1NC		Kırmızı	10	300	159,00
7049	A1 - 21XD - 24	1NO	0-1 Işıklı Mandal Buton 24V AC/DC	Sarı	10	300	159,00
7050	A1 - 31XD - 24	1NO		Mavi	10	300	159,00
7051	A1 - 20XSD	2NO		Yeşil	10	300	194,00
7052	A1 - 02XSD	2NC		Kırmızı	10	300	194,00
7053	A1 - 21XSD	2NO	1-0-2 Işıklı Mandal Buton 220V AC/DC	Sarı	10	300	194,00
7054	A1 - 31XSD	2NO		Mavi	10	300	194,00
7055	A1 - 20XSD - 110	2NO		Yeşil	10	300	194,00
7056	A1 - 02XSD - 110	2NC		Kırmızı	10	300	194,00
7057	A1 - 21XSD - 110	2NO	1-0-2 Işıklı Mandal Buton 110V AC/DC	Sarı	10	300	194,00
7058	A1 - 31XSD - 110	2NO		Mavi	10	300	194,00
7059	A1 - 20XSD - 24	2NO		Yeşil	10	300	194,00
7060	A1 - 02XSD - 24	2NC		Kırmızı	10	300	194,00
7061	A1 - 21XSD - 24	2NO	1-0-2 Işıklı Mandal Buton 24V AC/DC	Sarı	10	300	194,00
7062	A1 - 31XSD - 24	2NO		Mavi	10	300	194,00



Ø 22mm BUTON SERİSİ 40 mm KALICI MANTAR BUTON

Sipariş Kodu	Ürün Kodu	Kontak	Açıklama	Renk	Kutu Adet	Koli Adet	Fiyat TL. / AD.
7063	A1 - 01ZS	1NC	Stop Mantar Button	● Kırmızı	10	300	112,00



40 mm KALICI ANAHTARLI MANTAR BUTON

Sipariş Kodu	Ürün Kodu	Kontak	Açıklama	Renk	Kutu Adet	Koli Adet	Fiyat TL. / AD.
7064	A1 - 01ZA	1NC	Anahtarlı Stop Mantar Button	● Kırmızı	10	300	164,00



40mm KAYICI MANTAR BUTONLAR

Sipariş Kodu	Ürün Kodu	Kontak	Açıklama	Renk	Kutu Adet	Koli Adet	Fiyat TL. / AD.
7065	A1 - 01M	1NC	Stop Mantar Buton	● Kırmızı	10	300	100,00
7066	A1 - 10M	1NO	Stop Mantar Buton	● Yeşil	10	300	100,00
7067	A1 - 41M	1NO	Stop Mantar Buton	● Siyah	10	300	100,00



40mm KALICI MANTAR BUTONLAR

Sipariş Kodu	Ürün Kodu	Kontak	Açıklama	Renk	Kutu Adet	Koli Adet	Fiyat TL. / AD.
7075	A1 - 01ZF	1NC	Stop Mantar Buton	● STOP	10	300	188,00
7069	A1 - 01ZFD	1NC	Led Işıklı Stop Mantar Buton 220V AC/DC	● STOP	10	300	228,00
7070	A1 - 01ZFD - 110	1NC	Led Işıklı Stop Mantar Buton 110V AC/DC	● STOP	10	300	228,00
7071	A1 - 01ZFD - 24	1NC	Led Işıklı Stop Mantar Buton 24V AC/DC	● STOP	10	300	228,00



Ø 22mm BUTON SERİSİ BUTON AKSESUARLARI

Sipariş Kodu	Ürün Kodu	Açıklama	Kutu Adet	Fiyat TL. / AD.
7101	A - 10	1NO Start Kontak	50	35,00
7102	A - 01	1NC Stop Kontak	50	35,00
7103	A - D2	BA9S Led Kontak Yuvası (Buton için)	200	42,00
7104	XB2-EH2201	Plastik Buton Rozeti	100	5,00
7105	XB2-EH2208	Plastik Buton Rozeti (Geniş Etiketli)	100	5,00
7106	XB2-ER60	60mm Acil Stop Etiketli	100	14,25
7107	XB2-EC2	Acil Stop Butonu Koruma Kapağı	20	84,00
7108	XB2-EB40P	Buton Koruma Kapağı	5	70,00
7109	XB2-PE16A	Buton Koruma Kılıfı	100	11,00
7110	XB2-EC3	Acil Stop Butonu Koruma Kapağı	10	82,00



BOŞ BUTON KUTULARI

Sipariş Kodu	Ürün Kodu	Açıklama	Renk	Kutu Adet	Koli Adet	Fiyat TL. / AD.
7201	JBK 1 - SR	1'li Boş Kumanda Kutusu	Sarı - Siyah	1	100	57,80
7202	JBK 1 - GR	1'li Boş Kumanda Kutusu	Gri - Siyah	1	100	57,80
7203	JBK 2 - SR	2'li Boş Kumanda Kutusu	Sarı - Siyah	1	100	71,55
7204	JBK 2 - GR	2'li Boş Kumanda Kutusu	Gri - Siyah	1	100	71,55
7205	JBK 3 - SR	3'li Boş Kumanda Kutusu	Sarı - Siyah	1	100	93,00
7206	JBK 3 - GR	3'li Boş Kumanda Kutusu	Gri - Siyah	1	100	93,00
7207	JBK 4 - SR	4'lü Boş Kumanda Kutusu	Sarı - Siyah	1	50	117,00
7208	JBK 4 - GR	4'lü Boş Kumanda Kutusu	Gri - Siyah	1	50	117,00
7209	JBK 5 - SR	5'li Boş Kumanda Kutusu	Sarı - Siyah	1	50	175,00
7210	JBK 5 - GR	5'li Boş Kumanda Kutusu	Gri - Siyah	1	50	175,00
7211	JBK 6 - SR	6'lı Boş Kumanda Kutusu	Sarı - Siyah	1	50	175,00
7212	JBK 6 - GR	6'lı Boş Kumanda Kutusu	Gri - Siyah	1	50	175,00



KUTULU ACİL STOP BUTON

Sipariş Kodu	Ürün Kodu	Kontakt	Açıklama	Renk	Kutu Adet	Koli Adet	Fiyat TL. / AD.
7213	JK-ASB	NC	1'li Mantar Acil Stop Buton	Sarı - Siyah	1	100	148,00



Ø 22mm VOLTMETRE

Sipariş Kodu	Ürün Kodu	Çap (mm)	Açıklama	Renk	Kutu Adet	Koli Adet	Fiyat TL. / AD.
7301	AD-136-22DSV-K	22	24-550V Led'li Voltmetre	● Kırmızı	10	500	120,00
7302	AD-136-22DSV-Y	22	24-550V Led'li Voltmetre	● Yeşil	10	500	120,00
7303	AD-136-22DSV-S	22	24-550V Led'li Voltmetre	● Sarı	10	500	120,00
7304	AD-136-22DSV-M	22	24-550V Led'li Voltmetre	● Mavi	10	500	120,00
7305	AD-136-22DSV-B	22	24-550V Led'li Voltmetre	○ Beyaz	10	500	120,00



Ø 22mm AMPERMETRE

Sipariş Kodu	Ürün Kodu	Çap (mm)	Açıklama	Renk	Kutu Adet	Koli Adet	Fiyat TL. / Mt.
7306	AD-136-22DSA-K	22	0-100A Led'li Ampermetre Akım Trafolu	● Kırmızı	5	300	240,00
7307	AD-136-22DSA-Y	22	0-100A Led'li Ampermetre Akım Trafolu	● Yeşil	5	300	240,00
7308	AD-136-22DSA-S	22	0-100A Led'li Ampermetre Akım Trafolu	● Sarı	5	300	240,00
7309	AD-136-22DSA-M	22	0-100A Led'li Ampermetre Akım Trafolu	● Mavi	5	300	240,00
7310	AD-136-22DSA-B	22	0-100A Led'li Ampermetre Akım Trafolu	○ Beyaz	5	300	240,00



Ø 22mm LED'Lİ SİNYALLER



Sipariş Kodu	Ürün Kodu	Çap (mm)	Açıklama	Renk	Kutu Adet	Koli Adet	Fiyat TL. / AD.
7311	AD136-22DS-K	22	Led Sinyal 220V AC/DC	● Kırmızı	10	500	32,00
7312	AD136-22DS-Y	22	Led Sinyal 220V AC/DC	● Yeşil	10	500	32,00
7313	AD136-22DS-S	22	Led Sinyal 220V AC/DC	● Sarı	10	500	32,00
7314	AD136-22DS-M	22	Led Sinyal 220V AC/DC	● Mavi	10	500	32,00
7315	AD136-22DS-B	22	Led Sinyal 220V AC/DC	○ Beyaz	10	500	38,00
7316	AD136-22DS-110-K	22	Led Sinyal 110V AC/DC	● Kırmızı	10	500	32,00
7317	AD136-22DS-110-Y	22	Led Sinyal 110V AC/DC	● Yeşil	10	500	32,00
7318	AD136-22DS-110-S	22	Led Sinyal 110V AC/DC	● Sarı	10	500	32,00
7319	AD136-22DS-110-M	22	Led Sinyal 110V AC/DC	● Mavi	10	500	32,00
7320	AD136-22DS-110-B	22	Led Sinyal 110V AC/DC	○ Beyaz	10	500	38,00
7321	AD136-22DS-24-K	22	Led Sinyal 24V AC/DC	● Kırmızı	10	500	32,00
7322	AD136-22DS-24-Y	22	Led Sinyal 24V AC/DC	● Yeşil	10	500	32,00
7323	AD136-22DS-24-S	22	Led Sinyal 24V AC/DC	● Sarı	10	500	32,00
7324	AD136-22DS-24-M	22	Led Sinyal 24V AC/DC	● Mavi	10	500	32,00
7325	AD136-22DS-24-B	22	Led Sinyal 24V AC/DC	○ Beyaz	10	500	38,00

Ø 16mm LED'Lİ SİNYALLER

Sipariş Kodu	Ürün Kodu	Çap (mm)	Açıklama	Renk	Kutu Adet	Koli Adet	Fiyat TL. / AD.
7326	AD136-16DS-K	16	Led Sinyal 220V AC/DC	● Kırmızı	20	1000	44,00
7327	AD136-16DS-Y	16	Led Sinyal 220V AC/DC	● Yeşil	20	1000	44,00
7328	AD136-16DS-S	16	Led Sinyal 220V AC/DC	● Sarı	20	1000	44,00
7329	AD136-16DS-M	16	Led Sinyal 220V AC/DC	● Mavi	20	1000	44,00
7330	AD136-16DS-B	16	Led Sinyal 220V AC/DC	○ Beyaz	20	1000	60,00
7331	AD136-16DS-110-K	16	Led Sinyal 110V AC/DC	● Kırmızı	20	1000	44,00
7332	AD136-16DS-110-Y	16	Led Sinyal 110V AC/DC	● Yeşil	20	1000	44,00
7333	AD136-16DS-110-S	16	Led Sinyal 110V AC/DC	● Sarı	20	1000	44,00
7334	AD136-16DS-110-M	16	Led Sinyal 110V AC/DC	● Mavi	20	1000	44,00
7335	AD136-16DS-110-B	16	Led Sinyal 110V AC/DC	○ Beyaz	20	1000	60,00
7336	AD136-16DS-24-K	16	Led Sinyal 24V AC/DC	● Kırmızı	20	1000	44,00
7337	AD136-16DS-24-Y	16	Led Sinyal 24V AC/DC	● Yeşil	20	1000	44,00
7338	AD136-16DS-24-S	16	Led Sinyal 24V AC/DC	● Sarı	20	1000	44,00
7339	AD136-16DS-24-M	16	Led Sinyal 24V AC/DC	● Mavi	20	1000	44,00
7340	AD136-16DS-24-B	16	Led Sinyal 24V AC/DC	○ Beyaz	20	1000	60,00



BA9S LED AMPULLER

Sipariş Kodu	Ürün Kodu	Açıklama	Renk	Kutu Adet	Koli Adet	Fiyat TL. / AD.
7341	BA9SC - K	Led Ampul 220V AC/DC	● Kırmızı	50	4.000	38,00
7342	BA9SC - Y	Led Ampul 220V AC/DC	● Yeşil	50	4.000	38,00
7343	BA9SC - S	Led Ampul 220V AC/DC	● Sarı	50	4.000	38,00
7344	BA9SC - M	Led Ampul 220V AC/DC	● Mavi	50	4.000	38,00
7345	BA9SC - B	Led Ampul 220V AC/DC	○ Beyaz	50	4.000	46,00
7346	BA9SC - 110V - K	Led Ampul 220V AC/DC	● Kırmızı	50	4.000	38,00
7347	BA9SC - 110V - Y	Led Ampul 220V AC/DC	● Yeşil	50	4.000	38,00
7348	BA9SC - 110V - S	Led Ampul 220V AC/DC	● Sarı	50	4.000	38,00
7349	BA9SC - 110V - M	Led Ampul 220V AC/DC	● Mavi	50	4.000	38,00
7350	BA9SC - 110V - B	Led Ampul 220V AC/DC	○ Beyaz	50	4.000	46,00
7351	BA9SC - 24V - K	Led Ampul 220V AC/DC	● Kırmızı	50	4.000	38,00
7352	BA9SC - 24V - Y	Led Ampul 220V AC/DC	● Yeşil	50	4.000	38,00
7353	BA9SC - 24V - S	Led Ampul 220V AC/DC	● Sarı	50	4.000	38,00
7354	BA9SC - 24V - M	Led Ampul 220V AC/DC	● Mavi	50	4.000	38,00
7355	BA9SC - 24V - B	Led Ampul 220V AC/DC	○ Beyaz	50	4.000	46,00

METAL LEDLİ SİNYALLER



Sipariş Kodu	Ürün Kodu	Çap (mm)	Açıklama	Renk	Kutu Adet	Koli Adet	Fiyat TL. / AD.
7401	J8-220-K	8	Metal Led Sinyal 220V. AC-DC	● Kırmızı	50	600	43,15
7402	J8-220-Y	8		● Yeşil	50	600	43,15
7403	J8-220-SR	8		● Sarı	50	600	43,15
7404	J8-220-M	8		● Mavi	50	600	43,15
7405	J8-220-B	8		○ Beyaz	50	600	47,00
7406	J8-24-K	8	Metal Led Sinyal 24V. AC-DC	● Kırmızı	50	600	43,15
7407	J8-24-Y	8		● Yeşil	50	600	43,15
7408	J8-24-SR	8		● Sarı	50	600	43,15
7409	J8-24-M	8		● Mavi	50	600	43,15
7410	J8-24-B	8		○ Beyaz	50	600	47,00
7411	J10-220-K	10	Metal Led Sinyal 220V. AC-DC	● Kırmızı	30	360	47,20
7412	J10-220-Y	10		● Yeşil	30	360	47,20
7413	J10-220-SR	10		● Sarı	30	360	47,20
7414	J10-220-M	10		● Mavi	30	360	47,20
7415	J10-220-B	10		○ Beyaz	30	360	55,00
7416	J10-24-K	10	Metal Led Sinyal 24V. AC-DC	● Kırmızı	30	360	47,20
7417	J10-24-Y	10		● Yeşil	30	360	47,20
7418	J10-24-SR	10		● Sarı	30	360	47,20
7419	J10-24-M	10		● Mavi	30	360	47,20
7420	J10-24-B	10		○ Beyaz	30	360	55,00
7421	J14-220-K	14	Metal Led Sinyal 220V. AC-DC	● Kırmızı	15	180	63,25
7422	J14-220-Y	14		● Yeşil	15	180	63,25
7423	J14-220-SR	14		● Sarı	15	180	63,25
7424	J14-220-M	14		● Mavi	15	180	63,25
7425	J14-220-B	14		○ Beyaz	15	180	66,50
7426	J14-24-K	14	Metal Led Sinyal 24V. AC-DC	● Kırmızı	15	180	63,25
7427	J14-24-Y	14		● Yeşil	15	180	63,25
7428	J14-24-SR	14		● Sarı	15	180	63,25
7431	J14-24-M	14		● Mavi	15	180	63,25
7432	J14-24-B	14		○ Beyaz	15	180	66,50

BUZZERLAR Ø 22mm LEDLİ BUZZER



Sipariş Kodu	Ürün Kodu	Çap (mm)	Açıklama	Renk	Kutu Adet	Koli Adet	Fiyat TL. / AD.
7433	22DS/MS	22	Sesli Led Flaşör İkazlı 220V. AC/DC	● Kırmızı	10	500	130,00
7434	22DS-MS110	22	Sesli Led Flaşör İkazlı 110V. AC/DC	● Kırmızı	10	500	130,00
7435	22DS/MS24	22	Sesli Led Flaşör İkazlı 24V. AC/DC	● Kırmızı	10	500	130,00
7451	22DS/MS12	22	Sesli Led Flaşör İkazlı 12V. AC/DC	● Kırmızı	10	500	130,00

Ø 22mm SESLİ BUZZER



Sipariş Kodu	Ürün Kodu	Çap (mm)	Açıklama	Renk	Kutu Adet	Koli Adet	Fiyat TL. / AD.
7436	22DS/M	22	Sesli İkazlı 220V. AC/DC	● Siyah	10	500	62,00
7437	22DS/M24	22	Sesli İkazlı 24V. AC/DC	● Siyah	10	500	62,00
7438	22DS-M110	22	Sesli İkazlı 110V. AC/DC	● Siyah	10	500	62,00

MOTORLU SİRENLER



Sipariş Kodu	Ürün Kodu	Açıklama	Kutu Adet	Koli Adet	Fiyat TL. / AD.
7439	MS-190/220V	75mm Metal Gövde 220V. AC (110 - 130dB)	1	40	530,00
7440	MS-190/24V	75mm Metal Gövde 24V. AC (110 - 130dB)	1	40	530,00
7441	MS-290/220V	110mm Metal Gövde 220AC (110-130dB)	1	40	595,00
7442	MS-290/24V	110mm Metal Gövde 24V (110-130dB)	1	40	595,00

ELEKTRONİK SİRENLER



Sipariş Kodu	Ürün Kodu	Açıklama	Kutu Adet	Koli Adet	Fiyat TL. / AD.
7443	ES-50-12/24	Plastik Gövde 120dB 12-24V. AC/DC	1	100	178.00
7444	ES-60-220	Plastik Gövde 120dB 220V. AC	1	100	282.00
7445	ES-60-12/24	Plastik Gövde 120dB 12-24V. AC	1	100	282.00

Ø 22mm POTANSİYOMETRE



Sipariş Kodu	Ürün Kodu	Çap (mm)	Açıklama	Kutu Adet	Koli Adet	Fiyat TL. / AD.
7446	JPT-5K	22	5K Potansiyometre Tek Turlu 220V. AC	10	500	190,00
7447	JPT-10K	22	10K Potansiyometre Tek Turlu 220V. AC	10	500	190,00

PANO İÇİ TERMOSTATLAR



Çalışma Ömrü : 100.000 Açma Kapama

Ölçüler : 60x33x43

Ağırlık : 40 gr

Koruma Sınıfı : IP20

Sipariş Kodu	Ürün Kodu	Kontakt	Açıklama	Kutu Adet	Koli Adet	Fiyat TL. / AD.
7448	KTS-010	NC	Isıtma Termostatı (0 - 60°C)	1	300	230,00
7449	KTS-011	NO	Soğutma Termostatı (0 - 60°C)	1	300	230,00
7450	ZR-011	NO	Soğuk-Sıcak Termostat (0-60 C)	1	300	295,00

VİNÇ KUMANDA BUTONLARI

PLASTİK VİNÇ KUMANDALAR (IP67)

Sipariş Kodu	Ürün Kodu	Açıklama	Kutu Adet	Koli Adet	Fiyat USD / Ad.
7501	VK - 2	Plastik Vinç Kumanda 2'li Tek Hızlı	1	72	5,80
7502	VK - 4	Plastik Vinç Kumanda 4'lü Tek Hızlı	1	48	7,50
7503	VK - 6	Plastik Vinç Kumanda 6'lı Tek Hızlı	1	42	10,00
7504	VK - 8	Plastik Vinç Kumanda 8'li Tek Hızlı	1	36	13,00



ACİL STOPLU PLASTİK VİNÇ KUMANDALAR (IP67)

Sipariş Kodu	Ürün Kodu	Açıklama	Kutu Adet	Koli Adet	Fiyat USD / Ad.
7505	VKB - 3	Plastik Vinç Kumanda 3'lü Tek Hızlı	1	50	23,00
7506	VKB - 5	Plastik Vinç Kumanda 5'li Tek Hızlı	1	40	32,00
7507	VKB - 7	Plastik Vinç Kumanda 7'li Tek Hızlı	1	30	41,00
7508	VKB - 9	Plastik Vinç Kumanda 9'lü Tek Hızlı	1	20	50,00

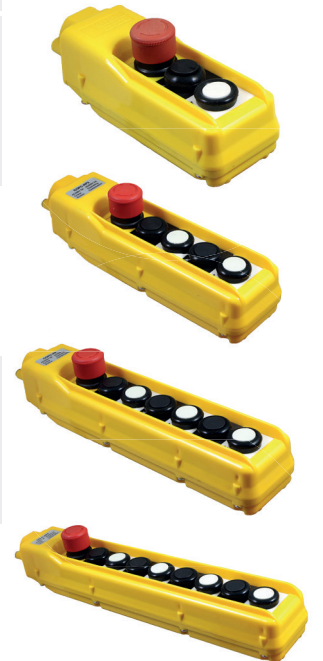

AYAK PEDALLARI

BİRİM FİYAT USD/Ad.	8,00	8,50 (metal)
SİPARİŞ KODU	7601	7602
ÜRÜN KODU	JP-1	
KUTU ADEDİ	1	
KOLİ ADEDİ	60	
AÇIKLAMA	METAL DÖKÜM ve PLASTİK PEDAL 1 mt Kablolü	

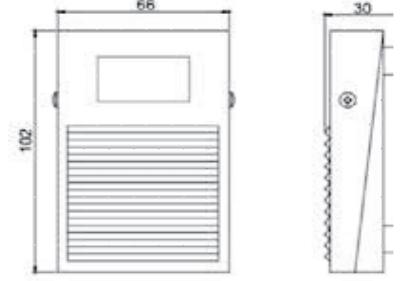

BİRİM FİYAT USD/Ad.	12,00	
SİPARİŞ KODU	7603	
ÜRÜN KODU	JP-2	
KUTU ADEDİ	1	
KOLİ ADEDİ	60	
AÇIKLAMA	ALÜMİNYUM DÖKÜM PEDAL 1 mt Kablolü	

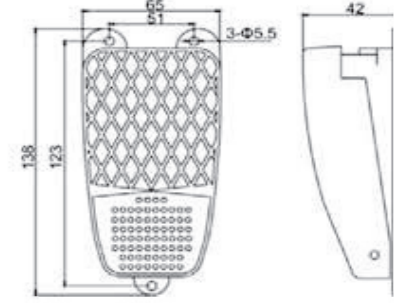

BİRİM FİYAT USD/Ad.	15,50	
SİPARİŞ KODU	7604	
ÜRÜN KODU	JP-3	
KUTU ADEDİ	1	
KOLİ ADEDİ	40	
AÇIKLAMA	ALÜMİNYUM DÖKÜM PEDAL 1 mt Kablolü	

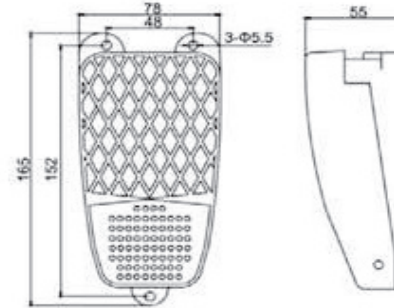

BİRİM FİYAT USD/Ad.	38,50	
SİPARİŞ KODU	7605	
ÜRÜN KODU	JP-9	
KUTU ADEDİ	1	
KOLİ ADEDİ	12	
AÇIKLAMA	METAL DÖKÜM PEDAL	

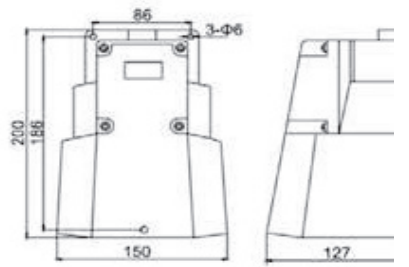

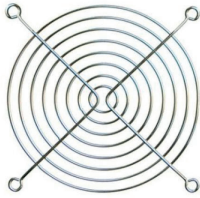

Jameson®

**SWITCH FAN
VE FİLTRE
ÇEŞİTLERİ**

www.kivilcimelektrik.com.tr

JLS SERİSİ LİMİT SWITCH

BİRİM FİYAT USD/Ad.	7,20
SİPARİŞ KODU	7701
ÜRÜN KODU	JLS-101
KUTU ADEDİ	10
KOLİ ADEDİ	100
AÇIKLAMA	Ayarlanabilir Metal Makaralı Çift Yön 1NO + 1 NC

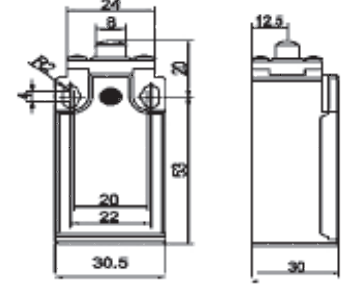

BİRİM FİYAT USD/Ad.	7,20
SİPARİŞ KODU	7702
ÜRÜN KODU	JLS-103
KUTU ADEDİ	10
KOLİ ADEDİ	100
AÇIKLAMA	Dikey Metal Makaralı Resetli 1NO + 1 NC

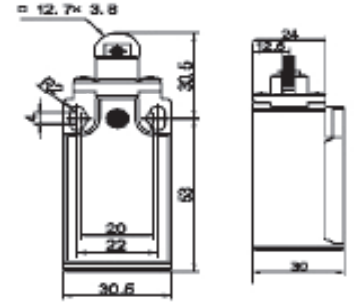

BİRİM FİYAT USD/Ad.	7,70
SİPARİŞ KODU	7703
ÜRÜN KODU	JLS-103-R
KUTU ADEDİ	10
KOLİ ADEDİ	100
AÇIKLAMA	Kısa Dikey Metal Pim 1NO + 1 NC

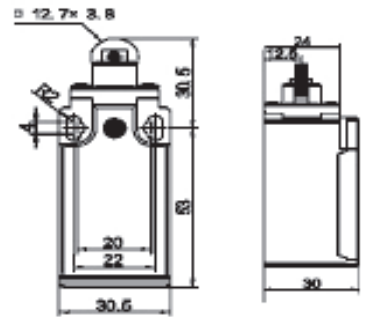

JLS SERİSİ LİMİT SWITCH

BİRİM FİYAT
USD/Ad. 7,20

SİPARİŞ KODU 7704

ÜRÜN KODU **JLS-111**

KUTU ADEDİ 10

KOLİ ADEDİ 100

AÇIKLAMA Açısal Metal Makaralı Tek Yön
1NO + 1 NC

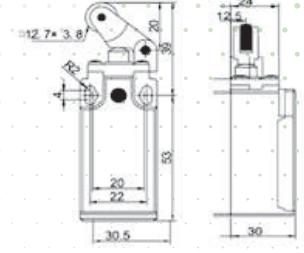
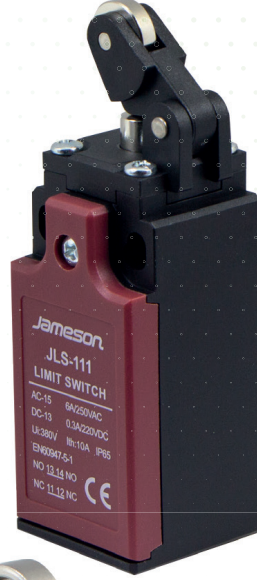

BİRİM FİYAT
USD/Ad. 7,20

SİPARİŞ KODU 7705

ÜRÜN KODU **JLS-121**

KUTU ADEDİ 10

KOLİ ADEDİ 100

AÇIKLAMA Dikey Metal Makaralı Çift Yön
1NO + 1 NC

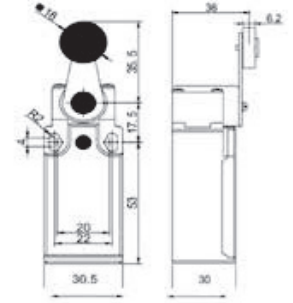

BİRİM FİYAT
USD/Ad. 7,20

SİPARİŞ KODU 7706

ÜRÜN KODU **JLS-127**

KUTU ADEDİ 10

KOLİ ADEDİ 100

AÇIKLAMA Ters Açısal Metal Makaralı Tek Yön
1NO + 1 NC

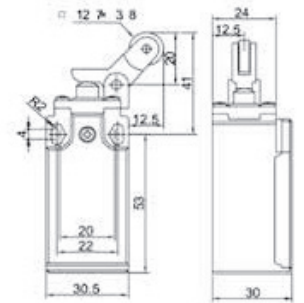

JLS SERİSİ LİMİT SWITCH

BİRİM FİYAT
USD/Ad. 7,50

SİPARİŞ KODU 7707

ÜRÜN KODU **JLS-131**

KUTU ADEDİ 10

KOLİ ADEDİ 100

AÇIKLAMA Ayarlanabilir Metal Makaralı
Çift Yön 1NO + 1 NC

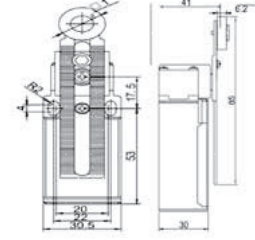
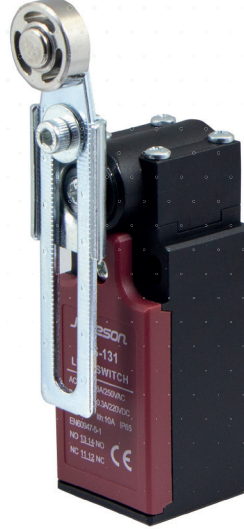

BİRİM FİYAT
USD/Ad. 7,50

SİPARİŞ KODU 7708

ÜRÜN KODU **JLS-161**

KUTU ADEDİ 10

KOLİ ADEDİ 100

AÇIKLAMA Çok Yönlü Spiral Tel Uç
1NO + 1 NC

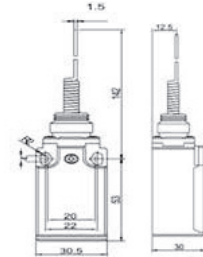

BİRİM FİYAT
USD/Ad. 7,50

SİPARİŞ KODU 7709

ÜRÜN KODU **JLS-171**

KUTU ADEDİ 10

KOLİ ADEDİ 100

AÇIKLAMA Çok Yönlü Spiral Plastik Uç
1NO + 1 NC

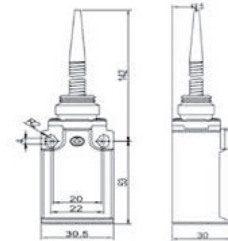

JLS SERİSİ LİMİT SWITCH

BİRİM FİYAT
USD/Ad. 7,50

SİPARİŞ KODU 7710

ÜRÜN KODU **JLS-191**

KUTU ADEDİ 10

KOLİ ADEDİ 100

AÇIKLAMA Ayarlanabilir Kauçuk Makara
Çift Yön 1NO + 1 NC

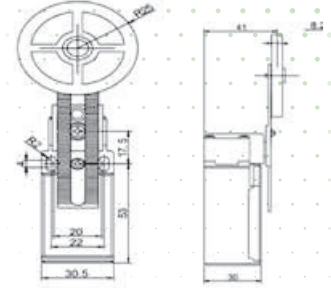
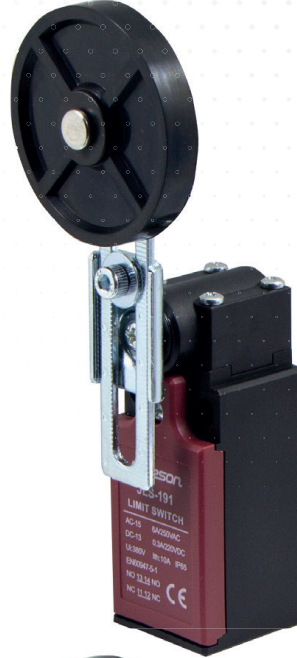

BİRİM FİYAT
USD/Ad. 9,50

SİPARİŞ KODU 7711

ÜRÜN KODU **JLS-191-R**

KUTU ADEDİ 10

KOLİ ADEDİ 100

AÇIKLAMA Ayarlanabilir Kauçuk Makara
Çift Yön 1NO + 1 NC

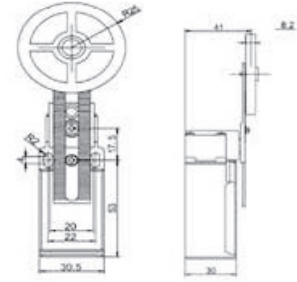

JMZ SERİSİ MİKRO SWITCH

BİRİM FİYAT USD/Ad.	3,85
SİPARİŞ KODU	7712
ÜRÜN KODU	JMZ-1300
KUTU ADEDİ	20
KOLİ ADEDİ	360
AÇIKLAMA	İnce Kısa Pimli 15A 1NO + 1 NC

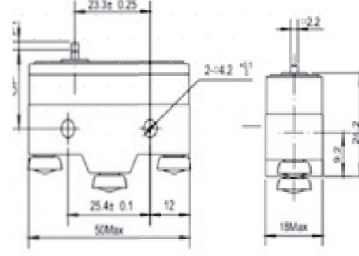

BİRİM FİYAT USD/Ad.	4,25
SİPARİŞ KODU	7713
ÜRÜN KODU	JMZ-1306
KUTU ADEDİ	20
KOLİ ADEDİ	360
AÇIKLAMA	Kalın Uzun Pimli 15A 1NO + 1 NC

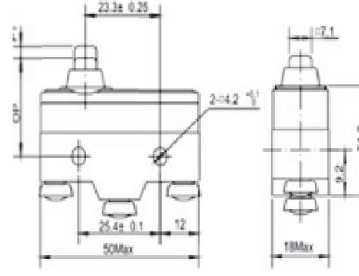

BİRİM FİYAT USD/Ad.	4,95
SİPARİŞ KODU	7714
ÜRÜN KODU	JMZ-1305
KUTU ADEDİ	20
KOLİ ADEDİ	360
AÇIKLAMA	İnce Uzun Pimli 15A 1NO + 1 NC

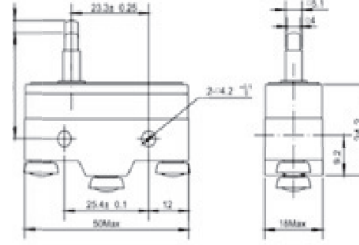

BİRİM FİYAT USD/Ad.	4,25
SİPARİŞ KODU	7715
ÜRÜN KODU	JMZ-1701
KUTU ADEDİ	20
KOLİ ADEDİ	360
AÇIKLAMA	Uzun Palet 15A 1NO + 1 NC

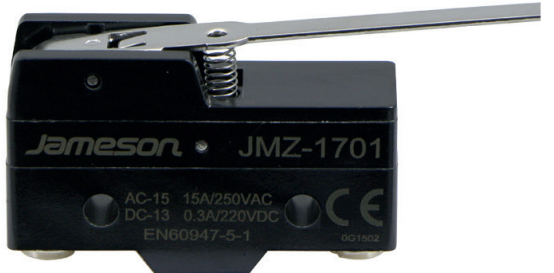
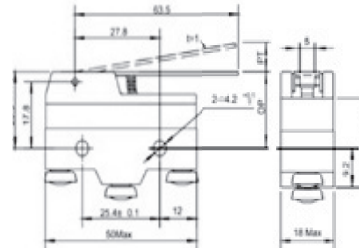

JMZ SERİSİ MİKRO SWITCH

BİRİM FİYAT USD/Ad.	4,60
SİPARİŞ KODU	7716
ÜRÜN KODU	JMZ-1703
KUTU ADEDİ	20
KOLİ ADEDİ	360
AÇIKLAMA	Uzun Palet Metal Makaralı 15A 1NO + 1 NC

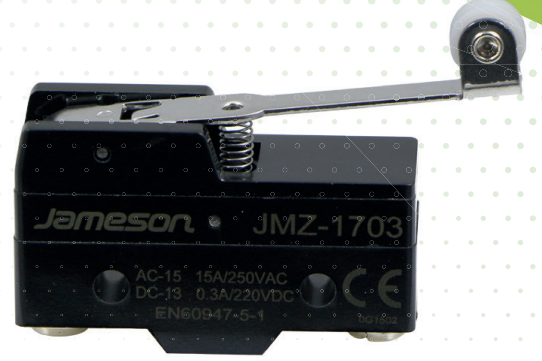
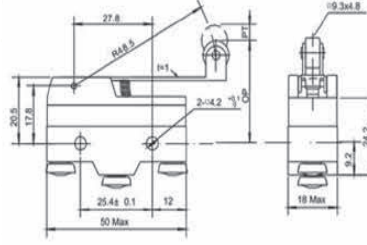

BİRİM FİYAT USD/Ad.	4,25
SİPARİŞ KODU	7717
ÜRÜN KODU	JMZ-1702
KUTU ADEDİ	20
KOLİ ADEDİ	360
AÇIKLAMA	Kısa Paletli 15A 1NO + 1 NC

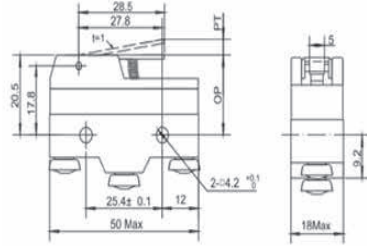

BİRİM FİYAT USD/Ad.	4,60
SİPARİŞ KODU	7718
ÜRÜN KODU	JMZ-1704
KUTU ADEDİ	20
KOLİ ADEDİ	360
AÇIKLAMA	Kısa Metal Makaralı 15A 1NO + 1 NC

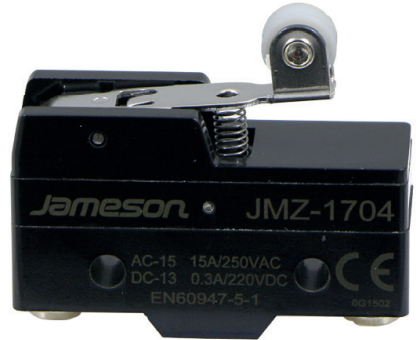
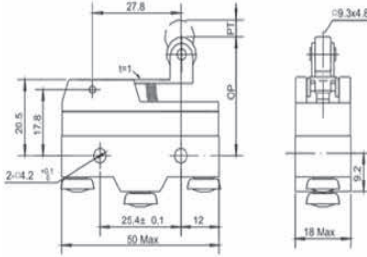

BİRİM FİYAT USD/Ad.	5,10
SİPARİŞ KODU	7719
ÜRÜN KODU	JMZ-1743
KUTU ADEDİ	20
KOLİ ADEDİ	360
AÇIKLAMA	Tahrikli Metal Makaralı 15A 1NO + 1 NC

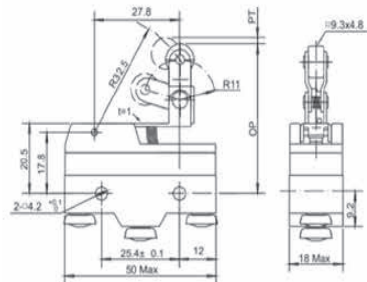

JMS SERİSİ MIKRO SWITCH

BİRİM FİYAT USD/Ad.	1,15		
SİPARİŞ KODU	7725	ÜRÜN KODU	JMS-100C
KUTU ADEDİ	100	KOLİ ADEDİ	1.800
AÇIKLAMA	100 Amper Plastik Pimli Mikro Switch		

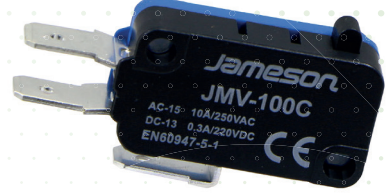

BİRİM FİYAT USD/Ad.	1.23		
SİPARİŞ KODU	7726	ÜRÜN KODU	JMS-101C
KUTU ADEDİ	100	KOLİ ADEDİ	1.800
AÇIKLAMA	100 Amper Orta Kollu Mikro Switch		



BİRİM FİYAT USD/Ad.	1.23		
SİPARİŞ KODU	7727	ÜRÜN KODU	JMS-102C
KUTU ADEDİ	100	KOLİ ADEDİ	1.800
AÇIKLAMA	100 Amper Kısa Kollu Mikro Switch		



BİRİM FİYAT USD/Ad.	1,38		
SİPARİŞ KODU	7728	ÜRÜN KODU	JMS-103C
KUTU ADEDİ	100	KOLİ ADEDİ	1.800
AÇIKLAMA	100 Amper Uzun Kollu Metal Makaralı Mikro Switch		



BİRİM FİYAT USD/Ad.	1,38		
SİPARİŞ KODU	7729	ÜRÜN KODU	JMS-104C
KUTU ADEDİ	100	KOLİ ADEDİ	1.800
AÇIKLAMA	100 Amper Kısa Kollu Metal Makaralı Mikro Switch		

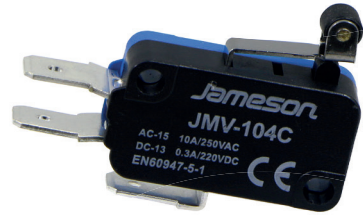

BİRİM FİYAT USD/Ad.	1,38		
SİPARİŞ KODU	7730	ÜRÜN KODU	JMS-105C
KUTU ADEDİ	100	KOLİ ADEDİ	1.800
AÇIKLAMA	100 Amper Uzun Kollu Mikro Switch		



BİRİM FİYAT USD/Ad.	1,38		
SİPARİŞ KODU	7731	ÜRÜN KODU	JMS-106C
KUTU ADEDİ	100	KOLİ ADEDİ	1.800
AÇIKLAMA	100 Amper Kıvrık Kollu Mikro Switch		



FANLAR

ÜRÜN KODU	KUTU ADET	Birim Fiyat USD.
JF-8025-24V	50	6.75
JF-8025-220V	50	9.00
JF-12025-24V	40	6.00
JF-12025-220V	40	11.25
JF-17050-24V	25	42.00
JF-17050-220V	25	27.00
JF-22580-220V	10	109.5



FAN FİLTRELERİ

ÜRÜN KODU	KUTU ADET	Birim Fiyat USD.
JF-107F	120	6.00
JF-148F	60	6.15
JF-205F	40	8.25
JF-255F	30	22.50



FAN KORUMA TELLERİ

ÜRÜN KODU	KUTU ADET	Birim Fiyat USD.
JF-80M	500	1.02
JF-120M	200	1.08
JF-170M	100	1.5
JF-225M	50	12.75

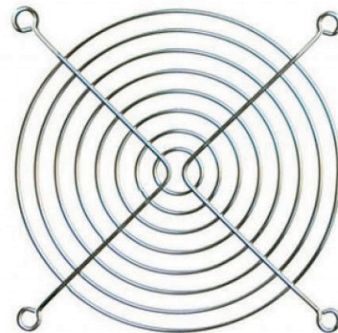



JAMESON®





Kivilcim Elektrik

Merkez
Portakal Mahallesi 80046 Sokak
No: 10/A Toroslar/MERSİN

Tel: 0531 727 74 64

Whatsapp Sipariş Hattı:
0531 727 74 64 

www.kivilcimelektrik.com.tr